



The wise choice

Culture Media and Supplies for Microbiology

Edition No. 7



THE COMPANY INTRODUCTION

Headquartered in Barcelona (Spain), Scharlab has experienced an important growth in the last few decades. This has enabled the company to serve its customers through a distribution network in over 100 countries and with direct presence in several other countries.

The company was founded in 1949 in Barcelona under the name of FEROSA as an organic synthesis company. In 1954, this company was bought by Paul Scharlau, a second generation German in Spain. He then reached an agreement with the German company Dr. Theodor Schuchardt to distribute their laboratory chemicals and to manufacture under license in Spain.

In 1970, Schuchardt was sold to Merck-Darmstadt and FEROSA had no alternative but to start selling chemicals under a different name. Thus the Scharlau brand was born in 1971. Thousands of purification processes were consequently perfected to offer reagents of exceptional purity.

In 1980, Paul Scharlau passed away and his son, Werner, took over the business. The company focused from then on in manufacturing high purity solvents in general and HPLC solvents in particular.

In 1991 FEROSA acquired a Spanish company manufacturing dehydrated culture media for microbiology. In 1993 the first edition of the catalogue for culture media is published and export of these products began. With regard to the Spanish market, Reactivos Scharlau decided to become a distributor of Laboratory Supplies. It was organized into five major product categories: Chemistry, Microbiology, Chromatography, Glassware, Consumables, Safety and Equipment. The widespread improvement in logistics in Spain helped Reactivos Scharlau to become one of the leading distributors of laboratory supplies in Spain.

Today, the company offers a complete portfolio of laboratory supplies and operates under the Scharlab company name and Scharlau product brand, employing over 300 people. Scharlab does not belong to a private equity fund, which means it can focus on long-term goals that guarantee stability for both its customers and team.

Scharlab is a company dedicated to design, manufacture and distribute products and services supporting scientists to achieve a better world.

In this catalogue you will find all Scharlau branded products designed to be used in a **Microbiological laboratory: Culture Media, Strains, Chemicals and Reagents, Glassware and Consumables**. There is also information regarding the documentation that supports the quality of the products, where to find it and how to interpret it.

We hope that you find this new Catalogue useful, facilitating your daily work. Should you not find what you need, please contact us by email at helpdesk@scharlab.com. Alternatively, you may enquire via our web site www.scharlab.com.



GENERAL INDEX

INTRODUCTION	
THE COMPANY. QUALITY AND THE ENVIRONMENT	5
THE COMPANY. CORPORATE WEBSITE	9
CULTURE MEDIA	11
GLASSWARE	163
CONSUMABLES	209
INDEX	
CROSS REFERENCES	240
BBL-SCHARLAU	240
DIFCO-SCHARLAU	242
MERCK-SCHARLAU	246
OXOID-SCHARLAU	250
CULTURE MEDIA PRODUCT INDEX	254
CULTURE MEDIA NUMERICAL INDEX	265
GLASSWARE & CONSUMABLES PRODUCT INDEX	270
GLASSWARE & CONSUMABLES NUMERICAL INDEX	273



Caring about the environment
is caring about you

We are committed to fulfilling or exceeding customer expectations by implementing a management system, which includes outstanding quality of service and products, the preservation of the environment, while also ensuring the health & safety of our personnel.

Since 1995 we have been operating a quality system in accordance with ISO 9001 requirements, and since 2002, an environmental system for our chemical production unit according to ISO 14001. Scharlab also meets the Spanish legal requirements (law 31/95) regarding health & safety in the work place.

Scharlab is in the process of implementing ENAC accreditation for the ISO 17025 standard with respect to pH determinations in buffered solutions and volumetric solutions, to demonstrate the technical competence in assigning values for the reference materials produced. Once this certification is accredited, Scharlab will implement and accredit the ISO 17034 for the production of certified reference materials. In parallel, Scharlab already markets standard solutions for ICP, atomic absorption and organic standards produced in an ISO 17025 and ISO 17034 accredited laboratory.

We have an integrated manual for all three areas, including written procedures and documentation related to the management of business in accordance with the requirements for this quality system.

A Quality Assurance department, independent from other operating units and reporting to the general manager, is responsible for the control, implementation and enhancement of this comprehensive management system.

Specifications

All products we manufacture or distribute have written specifications available to customers via our catalogues and technical documentation. Our Technical Data Sheets (TDS) include the most relevant information on the product. Custom-made products according to customer specifications are also possible.

Batch Documentation

Each product batch produced under the Scharlab brand is provided with a Certificate of Analysis (CoA) containing the guaranteed specifications, the current batch results, expiry date and relevant information regarding storage conditions, if required.

Certificates and Documentation

Details concerning the origin of a product such as BSE, GMO, allergens, etc., may be available on request. However, such information is limited to those articles which are intended to be used in final products that have potential for exposure to humans or animals. Additional administrative fees may apply.

This documentation is not available for expired batches and superseded or withdrawn products.

Expiry dates

All our products have an expiry date printed on the labels and Certificates of Analysis based on experimental or historical data.

Such dates indicate until when the product should fulfil its specifications when stored and used in accordance with the recommended conditions. We do not recommend using the product after this date.

As a general rule, the product should meet the specifications, once opened, as long as the recommended storage conditions are maintained. The CoA provided with the product includes details regarding any specific storage conditions that are recommended (refer to: 'Storage and Use'). In some cases, specific statements are issued for unstable products.

No retest dates are applied to our products.

THE COMPANY

QUALITY AND THE ENVIRONMENT

Audits

Audits of our premises are permitted with prior notification.

Scharlab reserves the right to postpone, cancel or modify a scheduled audit.

Customer Complaints

Scharlab handles customer complaints according to written procedures in the management system.

All customer complaints are checked and an official response is issued, including, when appropriate, the corrective actions implemented.

An internal blog has been put in place on our Intranet, which allows everybody in the company to follow up the status of each complaint.

Change Control

We consider any critical changes with regard to products, facilities and services that may affect pharmaceutical customers.

For that reason, Scharlab is in a position to notify significant changes of selected products if a Quality Agreement that indicates so, has been signed. This may be subject to an annual minimum consumption of each product.



Environmental Impact

Preservation of the environment is one of the company's main concerns. Scharlab works on continuous improvement to ensure that natural resources and raw materials are used efficiently. Our new facilities in the chemical unit, located in a rural area, have been designed to reduce the impact on the surrounding countryside.

Environmental Products and Services

We continue to work towards cleaner and safer products and we consider the preservation of the environment in all future projects. Thus, we are continuously searching for cleaner, safer ways to manufacture and package products and to include services in our portfolio. Learn more about what we do for the environment by referring to details regarding our Returnable Drums Service and Packaging.





Scharlab at your fingertips

Our website offers innovative solutions regarding to the information you are looking for, and puts powerful laboratory tools at your disposal.

Corporate Website

Products

Efficient product search

The search engine has been optimised enabling you to find all our products more easily and intuitively.

- Quick product search
- Products classified by application
- Products classified by industry

Comprehensive information

We include detailed information about:

- Product families
- Product grades/qualities
- Laboratory techniques
- Products used in production processes

Services

Because a high-quality product requires a high-quality service, our challenge is to make your life easier.

Custom-Made Products

To address the challenges facing professionals in laboratories, we offer a wide range of solutions developed by our R&D department and certified by our laboratory.

Returnable Drum Service

A simple system for the management of solvents, providing drums for exclusive use by an individual customer.

Media Room

Keep up-to-date with relevant information for your daily activities and the upcoming events which we will be hosting.

Labtools

Discover our tools for chemistry, which will support you in your daily laboratory activities.

- 3D Structures
- Abbreviations
- Apps
- Blends calculator
- GHS pictograms
- Interactive periodic table
- Molar mass calculator
- Molarity, normality
- Pathogen Guide
- pH indicator selector
- Solvents miscibility chart
- Synonyms
- Unit converter

Support

Download all the documents you need:

- Certificates of Analysis
- Technical Data Sheets
- Safety Data Sheets
- ISO Certificates
- Catalogues
- Leaflets
- Other promotional material
- Video tutorials & podcasts
- FAQs regarding every product line

Download this catalogue



CULTURE MEDIA

INTRODUCTION

PRODUCT DOCUMENTATION	12
ISO 17025	16
FOOD MICROBIOLOGY - NEW BROCHURE	17
PACKAGING ADVANTAGES	18
BACTERIAL STRAINS	30
PRODUCT LABEL	32
SAFETY	
CLP COMPLIANCE & PRODUCT INFORMATION	34
INDEX ABBREVIATIONS	35

DEHYDRATED AND PREPARED CULTURE MEDIA

CHROMOGENIC MEDIA MICROINSTANT®	128
CHROMOGENIC MEDIA CHROMagar™	132
CHROMOGENIC MEDIA COMPACT DRY®	142
ADDITIVES FOR CULTURE MEDIA	144

INGREDIENTS AND CHEMICAL PRODUCTS FOR MICROBIOLOGY

SELECTIVE SUPPLEMENTS

MISTRACON® - BACTERIAL STRAINS

REAGENTS FOR MICROBIOLOGICAL APPLICATIONS

REAGENTS FOR BIOCHEMICAL TESTS	156
REAGENTS FOR MOLECULAR BIOLOGY	158
OTHER REAGENTS	160



PRODUCT DOCUMENTATION

Introduction

Scharlab offers dehydrated and prepared culture media. Additionally, our range includes additives, supplements, reagents, and dyes for biochemical confirmation tests.

The quality of our media

Our range includes more than 400 culture media. They are manufactured following our quality system, according to ISO 9001: 2015 and ISO 13485. Furthermore, our media comply with validated methods, international standards and microbiological guidelines (ISO, FDA, Pharmacopoeias, etc.). All this means that they can be used for a wide range of applications for both the clinical and industrial sectors (pharmaceutical, cosmetics, food, water and environmental analysis, service provider laboratories, etc.).



Certificates of Analysis

Certificates of Analysis (CoA) are available for the different batches manufactured in PDF on our web www.scharlab.com. They include both physical-chemical parameters and fertility tests according to the different standards, in particular ISO 11133: 2018, regarding the criteria to be followed in the performance tests for culture media.

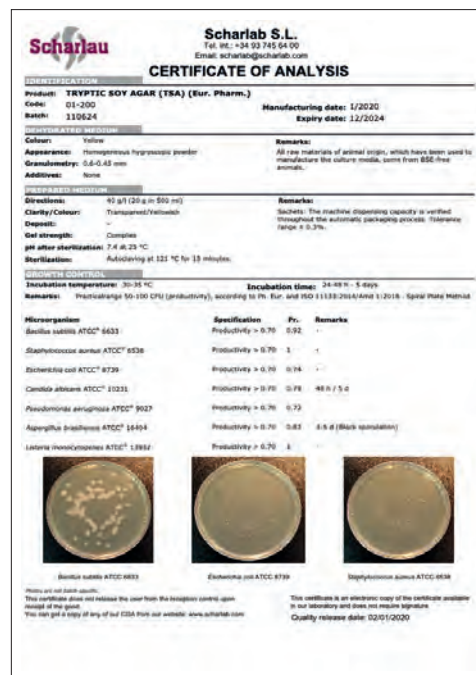

Product specifications and Safety Data Sheets

Product specifications and Safety Data Sheets are available in PDF on our website, www.scharlab.com. They are revised and updated as soon as there are any changes in relation to the products (formulation, preparation, standards, control, preservation, format, etc.).

Documentation

BSE free certificate

Scharlab S.L. hereby states that among the raw materials used in its preparation, the bovine constituents belong to the category IB, according to “Note for Guidance EMEA/410/01 Rev. 3”.

The bovine tissue are sourced from New-Zealand, and comes from herds declared free from Bovine Spongiform Encephalopathy and Foot-and-Mouth disease after examination by the Veterinary Authorities.

The product does not contain and is not derived from specified risk material as defined in the European Commission Decision 97/534/EC.

The manufacturing process includes boiling at 100°C for a minimum of 5 minutes and instantaneous heating at 150°C minimum on spray drying.



Scharlab
The wise choice

24/05/2020

TO WHOM IT MAY CONCERN

This is to certify that in all Certificates of Analysis for culture media the origin and treatment of the product is stated, along with a BSE/TSE declaration, if applicable. For example:

Scharlab S.L.
CERTIFICATE OF ANALYSIS

Product: WHEAT EXTRACT	Production date: 07/2021
Date: 05/2021	Expiration date: 07/2021

Yours faithfully,

Walter Armada
Quality Director
Scharlab S.L.

SCHARLAB S.L. - Calle Pinar, 33, P.I. Mas de les Cols, 08191 Sant Joan de Vilatorrada (Barcelona) - Tel: +34 935 46 110 - Fax: +34 935 218 27 58
Tlx: 66 66 66 66 - www.scharlab.com - scharlab@scharlab.com

Les dades i informació de productes i preus són només orientatives i no són vinculants fins que no s'ha signat el contracte amb Scharlab S.L. En cas de qualsevol dubte o qüestió, contactar amb el servei al client de Scharlab S.L. o amb el departament de vendes de Scharlab S.L. Scharlab S.L. és una empresa que opera sota el marc de la normativa europea i està registrada a l'Oficina d'Inscripció de l'Administració de l'Estat. Scharlab S.L. és una empresa que opera sota el marc de la normativa europea i està registrada a l'Oficina d'Inscripció de l'Administració de l'Estat. Scharlab S.L. és una empresa que opera sota el marc de la normativa europea i està registrada a l'Oficina d'Inscripció de l'Administració de l'Estat.

Page 1 of 1



To see an example of the document, consult the attached QR code.

Documentation

Irradiation certificate

Products used in environmental and surface control analysis in sterile wards, such as the production facilities of pharmaceutical industries, are required to be 100% free from particles or any contaminant that could cross-contaminate the zone under test.

For these special situations we offer gamma-irradiated plates with double or triple packaging in order to facilitate transport of the plates from non-sterile to the sterile zone and eliminating the risk of contamination.

For the Media Fill Test (MFT) as used in pharmaceutical and beverage companies, dehydrated and irradiated TSB (Tryptic Soy Broth) is also required, in order to reproduce the production process as realised in the manufacture of actual products.

The product includes an indicative irradiation label that turns from yellow to orange, following the successful completion of the process.

NOTE: If necessary, the irradiation certificate can be requested.

Descripción tracking		Fecha/hora	
EN TRANSITO		23/05/2018 21:36:05	
LEGENDA EDUCACION DE BOTTING		24/05/2018 09:59:58	
ESPONJON EN NEUMATO		24/05/2018 09:50:02	
ESPONJON EN NEUMATO		23/05/2018 12:43:08	
ESPONJON EN ENTREGA		23/05/2018 11:49:03	
CONFIRMA ESCANEO		23/05/2018 21:51:07	

Resumen por Sonda					
Sonda	Creado	Estado	Min. °C	Max. °C	Fecha/Día
4891240	RECIBIDA	LECTURA FISUAL	23.81	24.81	23/05/2018 13:20:00
2037232	RECIBIDA EN PLAZA DE OBRAS AMBIENTE OBRERAS	LECTURA FISUAL	23.83	23.79	23/05/2018 13:15:00
2037932	LECTURA REAL	CERRA DE SALIDAS	23.81	23.79	23/05/2018 09:30:00
2160112	SERIE 18 MUESTRAS	ACTUALIZACION DE LEGENDA	18.00	22.00	23/05/2018 14:40:00
2039980	RECIBIDA EN PLAZA DE OBRAS	ENTRADA EN BIODIVERSIDAD	18.00	18.00	24/05/2018 08:00:00
2039844	ENTRADA ESTACIONADO	ASIGNACION NEUMATO	18.14	18.32	24/05/2018 07:00:00

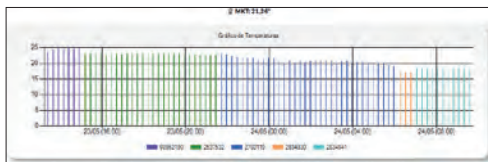

To see an example of the document, consult the attached QR code.

Transport tracking document

Our products are specially prepared to enable carriage by different transport methods.

Due to the special packaging used, which ensures the integrity of the product during transport (even when the transport occurs at extreme temperatures over a limited time), such storage requirements do not mean that the product necessarily be transported at the indicated temperature.

Our prepared culture media plates have been subjected to room temperature conditions (including thermal shocks between 14°C to 37°C) for 120 hours, thus verifying that the products conform in regard to appearance, pH and the ability to promote growth until the expiry date, as indicated on the package.

Scharlab S.L. controls, however, the temperature of some road transport modes to test conformity with the recommended transport conditions, which should be under 25°C. This control is performed by temperature probes in the trucks and the measurements are downloaded at our premises and analysed tracking by tracking.

Bruker Daltonik MALDI Biotyper Classification Results

Meaning of Score Values

Range	Interpretation	Symbol	Color
2.00 - 3.00	High confidence identification	(+++)	green
1.70 - 1.99	Low confidence identification	(+)	yellow
0.90 - 1.69	Low confidence identification	(-)	red

Meaning of Consistency Categories (A - C)

Category	Interpretation
(A)	High consistency: The best match is a high-confidence identification. The second-best match is (1) a high-confidence identification or which the species is identical to the best match, or (2) a non-identification.
(B)	Low consistency: The requirement for high consistency is not met. The best match is a high- or low-confidence identification. The second-best match is (1) a high- or low-confidence identification in which the genus is identical to the best match or (2) a non-identification.
(C)	No consistency: The requirements for high or low consistency are not met.

Sample Name: Staphylococcus aureus subsp. aureus
 Sample Description: 0486
 Sample ID: 486-001
 Sample Creation Date/Time: 2017-08-10 12:44:48.423 K916Z
 Applied MSP Library(s): DSM, Mycobacteria Library (read method), Fluorescence Pung Library 1.0, Lists

Sample Name	Sample ID	Organism (best match)	Score Value
486-001 (A)	486-001	Staphylococcus aureus	2.41

Comments:
N/A



To see an example of the document, consult the attached QR code.



Documentation - Other documents

Declaration of authorized use of dehydrated culture media in the field of public health and IVD products.

Scharlab, S.L. declares that the products included in the list of the attached document (see QR code below) belong to the variety of dehydrated culture media for microbiological tests, which can be carried out, among others, in food laboratories, pharmaceutical laboratories, cosmetics, public veterinary services and fraud detection, which operate in the field of public health and which can be freely available for these applications.

CE marked products

Scharlab, S.L. declares that the products listed in the attached document are CE marked and in compliance with CE marking requirements as applicable to each batch defined in the specifications.





STATEMENT

Sentmenat (Spain), 04/JUN/2020

Scharlab, S.L. declares that the following products are CE marked and in compliance with CE marking requirements as applicable to each batch defined in the specifications.

Type	Products
Culture media	01-001 CLED Agar 01-004 Blood Agar Base (Columbia) 01-118 MuellerHinton Agar 01-118 Agar MacConkey 01-126 Mueller Hinton Agar 01-312 Blood Agar Base 01-505 Blood Agar Base #2 01-555 Agar 55 (Salmonella Shigella Agar) 02-186 Thymogelate Broth 02-208 Salmonella Broth 02-509 Brain Heart Infusion Broth 02-602 Salmonella Curline Broth Base 03-454 Stuart Binger
Transport media	004-14330 Virus Transport Medium (CE-IVD)
Reference strains	500001-MSC: <i>Acetivibrio butzneri</i> ATCC® 34404™ / WDCM 00013 500002-MSC: <i>Pseudomonas aeruginosa</i> ATCC® 9027™ / WDCM 00026 500003-MSC: <i>Staphylococcus aureus</i> subsp. <i>aureus</i> ATCC® 6538™ / WDCM 00032 500004-MSC: <i>Escherichia coli</i> ATCC® 8739™ / WDCM 00012 500005-MSC: <i>Candida albicans</i> ATCC® 10211™ / WDCM 00014 500006-MSC: <i>Bacillus subtilis</i> subsp. <i>spizizenii</i> ATCC® 6613™ / WDCM 00003 500007-MSC: <i>Clostridium perfringens</i> ATCC® 31249™ / WDCM 00007 500008-MSC: <i>Enterococcus faecalis</i> ATCC® 9212™ / WDCM 00017 500009-MSC: <i>Escherichia coli</i> ATCC® 25922™ / WDCM 00011 500010-MSC: <i>Salmonella enterica</i> sensu lato <i>Typhimurium</i> ATCC® 14028™ / WDCM 00031 500011-MSC: <i>Clostridium sporogenes</i> ATCC® 33494™ / WDCM 00008 500012-MSC: <i>Burkholderia cepacia</i> ATCC® 25410™ 500013-MSC: <i>Staphylococcus epidermidis</i> ATCC® 12228™ / WDCM 00036 500014-MSC: <i>Bacillus cereus</i> ATCC® 11798™ / WDCM 00001 500015-MSC: <i>Enterobacter aerogenes</i> ATCC® 13687™ / WDCM 00175 500016-MSC: <i>Legionella</i> p. sub. <i> pneumophila</i> ATCC® 33152™ / WDCM 00107 500018-MSC: <i>Campylobacter jejuni</i> subsp. <i>jejuni</i> ATCC® 33291™ / WDCM 00005 500019-MSC: <i>Listeria innocua</i> ATCC® 33996™ / WDCM 00017 500020-MSC: <i>Listeria monocytogenes</i> ATCC® 19223™ / WDCM 00021 500021-MSC: <i>Proteus mirabilis</i> ATCC® 29906™ / WDCM 00023 500022-MSC: <i>Saccharomyces cerevisiae</i> ATCC® 9790™ / WDCM 00058 500023-MSC: <i>Citrobacter freundii</i> ATCC® 43846™ / WDCM 00006 500024-MSC: <i>Salmonella abortus</i> ATCC® 6011™ 500025-MSC: <i>Listobacillus endophthalmitidis</i> ATCC® 43561™ / WDCM 00098 500026-MSC: <i>Legionella arisa</i> ATCC® 35292™ / WDCM 00106 500027-MSC: <i>Listobacillus sakai</i> subsp. <i>sakai</i> ATCC® 15221™ / WDCM 00015

 Marian Guardia
 Person Responsible for Regulatory Compliance

 Walter Armada
 Quality Director

SCHARLAB, S.L. - C/ Gato Pérez, 33 Pol. Ind. Misa D' en C/ta 08181 - Sentmenat (Barcelona) España.
Tel: +34 93 740 64 26 Fax: +34 93 740 51 96 www.scharlab.com
Page 1 of 1



To see an example of the document, consult the attached QR code.

Accreditation according to ISO 17025

Scharlab is proud to announce accreditation of the laboratory that carries out the performance tests of our Scharlau ready-to-use solid culture media, according to ISO 17025 (Testing laboratory, accredited by ENAC with accreditation N° 1392/LE2585).



The analysis is carried out through productivity, selectivity and specificity tests of the culture media according to internal methods based on ISO 11133: 2014 / Amd 1: 2018 / Amd 2: 2020, annexes C-2, E, F and K.

ISO 17025 is oriented towards testing and/or calibration laboratories, so that they can guarantee their confidence and technical capacity to carry out tests for external as well as internal clients.

ISO 17025 standard contains the requirements that testing and calibration laboratories have to meet to demonstrate the following:

- To have a management system
- To be technically competent
- To be able to generate technically valid results

ISO 17025 can be used to accredit laboratories, which guarantees for both user and consumer, that the quality and technical competence of their tests are evaluated by competent, qualified and internationally recognised external bodies.

In Spain, accreditation of laboratories is performed by ENAC (National Accreditation Body; in Spanish: Entidad Nacional de Acreditación).

Scharlab is proud to announce accreditation of the laboratory that carries out the performance tests of our Scharlau ready-to-use solid culture media, according to ISO 17025 (Testing laboratory, accredited by ENAC with accreditation N° 1392/LE2585).

FOOD MICROBIOLOGY NEW BROCHURE

Food Microbiology

At Scharlab, we are aware of the technical complexity involved in applying regulations to standardised procedures for microbiological examinations for food products according to ISO standards.

For this reason, we have published a technical document entitled "Food Microbiology: Standardised Procedures for Microbiological Examinations of Food Products According to ISO Standards" to provide comprehensive technical support to the food industry.

In the technical document, you will find the ISO standards referenced in Regulation (CE) No. 1441/2007 summarised and outlined in a clear, understandable way. Equally, all the necessary culture media are indicated to apply the standard and its Scharlab product reference, to ease product ordering.

New
brochure

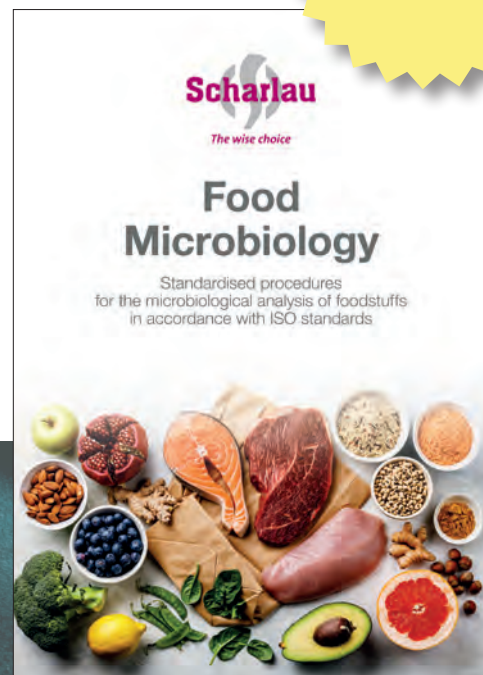

PACKAGING ADVANTAGES

Dehydrated culture media

Dehydrated culture media in 500 g flask

Control of the manufacturing process and the selection of high-quality ingredients, from validated suppliers, guaranteed batch to batch traceability and reproducibility of the final product.

We offer our dehydrated culture media in different formats adapted to our customers' requirements: pre-weighed envelopes to prepare 500 ml, flasks of 500 g and drums of 5 kg and 25 kg of medium.

Please contact us if you cannot find the culture medium you need in this catalogue. We can manufacture customized media according to the formulations proposed by our customers.

Expiry from the date of manufacture: the useful shelf life of dehydrated media is 4 years from the date of manufacture. As an exception and due to their formulation, some media may have a shorter shelf life. On the other hand, stability studies have allowed us to increase shelf life up to 5 years for some media. This information is available on the product sheets that can be downloaded from our website.

Dehydrated media in 500 g: our Pac-o-Vac® packaging

Our 500 g flasks are vacuum-packed in an additional external bag made of clear plastic called Pac-o-Vac®. This airtight packaging provides great protection against moisture, dust particles and microorganisms. It ensures optimal storage conditions and protects the product from alterations in its physical and organoleptic properties, even in unfavourable climate conditions.



PAC-o-VAC

External vacuum bag that offers protection against moisture and dust particles.

New 500 g DCM flask

High-quality cap

PP screw cap with PE inner liner, ensuring a perfect closure with the bottle and an inert contact with the content.

Wider opening for easier introduction of spoons.

More ergonomic

Oval shape for a more comfortable grip.

High-density, high-quality polyethylene

With greater resistance and durability, guaranteeing the highest quality and safety for the product.

New label with readable and more accessible information.

Wide and secure base to prevent tipping.



QR Code

By using the Scharlab Reader App you get direct access to the TDS, SDS and CoA of the product.

Smaller width

Freeing up shelf space to store more products.

More information about the Scharlab Reader App here:



5 and 25 kg bulks available.



PACKAGING ADVANTAGES

Dehydrated culture media

Dehydrated media in pre-weighed sachets

Dehydrated media in sachets are an ideal solution for media used in smaller quantities and for very expensive media. Media may not be consumed before the expiry date or get spoiled due to moisture.

An innovative solution with many advantages. Each sachet contains the amount required to prepare 500 ml of medium. No weighing is necessary, just open the envelope, add the content to 500 ml of water and sterilize. Valuable time used to weigh the powder can be saved as well as any errors associated to this process. The presentation is 5 envelopes per pack, so that with each pack, you can prepare 2.5 litres of medium. Great stability, as the envelopes keep their properties intact until they are opened. The standard expiry is 4 years; ideal for media that are used infrequently. They take up little space and generate little waste.



Aluminium sealed bag, containing pre-weighed culture media which prevents from product spoilage media with low consumption or with hygroscopic characteristics.



Label contains comprehensive information, specifications and hazards, batch number and expiry date.



Opening slot facilitates product manipulation.



Additives

The additives, substances or mixtures that have to be added to complete the formula of the medium, come in a format of opaque bottles of 100 ml. Short expiration dates.



Supplements

Freeze-dried supplements in the precise amounts to be added to the culture medium. We can also supply the sterile diluent in a separate container.

Presented in boxes of 10, the vials are very easy and safe to handle, thanks to their plastic screw cap. If desired, the rubber septum allows the sterile diluent to be added by injection, using a syringe.

Expiry from date of manufacture: depending on the product, the shelf life of supplements is between 3 and 4 years, if the storage conditions are maintained (usually 2°C-25°C, in darkness).

Supplement in **freeze-dried** form that dissolves easily and quickly.

Label contains **comprehensive information**, product name, batch number and shelf life.

Plastic screw cap.
For easy, safe handling.

Glassware vials that offer great stability for the product inside with a shelf life of 3-4 years.



PACKAGING ADVANTAGES

Prepared culture media

90 mm Petri dishes

The standard presentation is 20 plates (2 x 10 bagged plates).

Some references are available irradiated and in double or triple bags.

Expiry from manufacturing date: 3 months (some media may have shorter expiry dates).

The expiry for irradiated dishes is 4 months.

Pile of 10 plates of 90 mm.
Each box contains 2 piles of 10 (20 plates).



Silkscreened plates, indicating the product name, batch and serial number and expiry date.

Semi-permeable cellophane bag that enables evaporation of possible water condensation that can be produced during transport due to temperature fluctuations.



Filtration plates

These plates are commonly used for the microbiological analysis of water or other liquids by membrane filtration technique. They are presented in a box that contains 5 packed plate piles (6 piles/unit x 5 plates/pile, 30 plates per sales unit).

Expiry from date of manufacture: 4 months.

Each box contains **6 packed groups of 5 plates each** (30 plates in total).



The group packed with film of 5 plates of filtration allows a **use adjusted to the need**.



Screen-printed plates, which indicate the name of the product, the batch and serial number and the expiration date.

55 mm filtration plates suitable for the incubation of membranes with 47 mm diameter.

PACKAGING ADVANTAGES

Prepared culture media

Contact plates

Plates for microbiological control of surfaces are presented in 2 types of format:

- Blister of 6 plates separated individually (5 blister x 6 plates = 30 plates in total).
- RD-pack (8 x 10 plates = 80 plates in total). Double or triple optional packaging.

Contact plates are irradiated for almost all media.

Expiry from manufacturing date: 4-6 months depending on the culture medium.

Both formats, include an indicative label confirming that the irradiation process has been performed successfully. The label turns from yellow to red-range when the product has received correct irradiation dose.

Each box contains 5 blisters of 6 plates (30 plates).

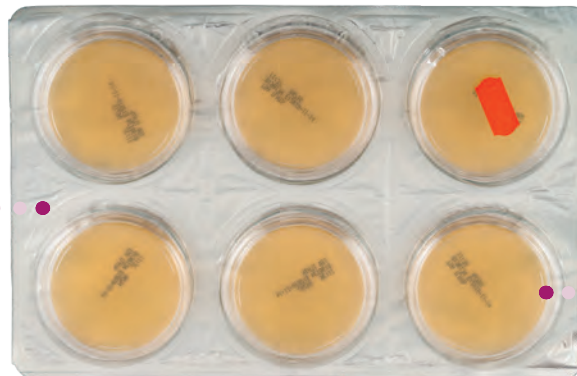

Aluminium blister pack, with 6 compartmented contact plates, which prevent any possible cross contamination. Available in double packaging (one cellophane bag) or in triple packaging (two cellophane bags).



RD-pack enables the transport of plates from sampling place to the laboratory.

Cellophane bag available in double packaging (one bag) or in triple packaging (two bags).



RD-pack is a **PET transparent box** with two piles of 5 contact plates. RD-pack enables the sterilization by gamma-irradiation and offers resistance to hydrogen peroxide gases. Each box contains 8 RD-pack.

Agars in flasks

Bottles containing solid culture media. To be re-melted without loss of nutritional capacity. With plastic cap suitable for microwaves. Presentation in boxes of 10 bottles of either 100 or 200 ml. Please ask for other volumes.

Expiry from manufacturing date: 12 months.

Broths in flasks

Liquid culture media ready for use, generally for pre-enrichment of samples. Standard presentation with tight-fitting metal lid. Additionally, those for sterility control have a plug with septum.

Available volumes of 90, 100, 200 and 225 ml in boxes of 10 bottles. Please ask for other volumes.

Expiry from manufacturing date: 12 months.

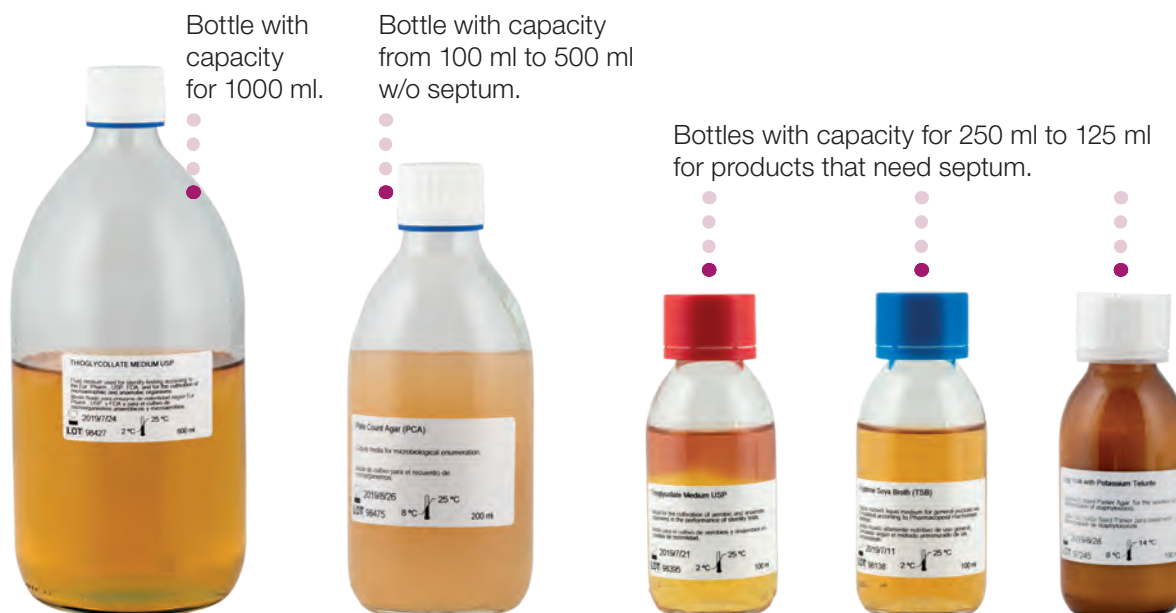

Glassware bottles that offer **great stability** to the product inside and provide a shelf life of 12 months. Culture media in liquid or solid agar presentation.

PACKAGING ADVANTAGES

Prepared culture media

Characteristics of the caps of agars and broths flasks



White screw cap without protection. According to references, it can be used with or without blue tamper evident ring*.



White screw cap with one injectable hole and a blue tamper evident ring.



White screw cap with injected liner made of TPE and two injectable holes.

Red outer protection. Red tamper evident ring.

Specific for Thioglycollate references.



White screw cap with injected liner made of TPE and two injectable holes.

Blue outer protection. Blue tamper evident ring.

Specific for Tryptic Soy Broth references.



White screw cap with injected liner made of TPE and two injectable holes.

Transparent outer protection. Transparent tamper evident ring.

*NOTE: This cap is being replaced by the white screw cap with one injectable hole and a blue tamper evident ring.

Bottles with a capacity of 125, 250 and 500 ml are delivered in boxes of 10 bottles.



Bottles with a capacity of 1000 ml are delivered in boxes of 6 bottles.



The six bottles are fitted in a plastic box and the plastic box is packed in a paper bag.



Each box includes **10 self-adhesive labels** with the product name, batch number and expiry date.

ESTERIPAPEL® packaging, specific for the pharmaceutical industry. 6 bottles of 125 ml capacity and 10 self-adhesive labels with the product name, batch number and expiry date.

Agars in tubes

Tubes containing solid culture media (15 ml) to be re-melted without loss of nutritional capacity. The content of one tube is enough to fill a 90 mm petri dish, ideal for bulk plantings. With metallic cap suitable for microwaves. Package of 20 tubes (depending on the medium, agar slant tubes are also available).

Expiry from manufacturing date: 12 months.

Broths in tubes

Tubes of liquid culture medium. Plug with special closure that guarantees sterility and stability of the medium. The filling system guarantees a minimum deviation in the volumes to obtain accurate and reproducible results, something very important when working with the Most Likely Number (NMP) technique. Available in 5, 10, 19 and 20 ml (box of 20 tubes).

Expiry from manufacturing date: 12 months.

Box with **20 tubes**.



Silkscreened tubes, indicating the product name, batch and serial number and expiry date.

Metallic cap suitable for the re-melt of the culture media in the microwave without the loss of nutrient properties.



Glassware tube that offers great stability to the product inside and allows a shelf life of 12 months.

Two size of tubes, 16 x 113 mm tube or 17 x 145 mm tube.

Culture media in **liquid, solid (agar) or semi-solid** presentation.

PACKAGING ADVANTAGES

Prepared culture media

Broths and diluents in bags (Flexibags)

Ideal presentation for microbiological food control laboratories with a large number of samples. Their most important advantages are:

- Ready for use product
- Economic
- Safe
- Generate less waste

Dosage: the dispensing of the desired volume in sterile homogenisation bags is by means of gravimetric diluents thanks to a peristaltic pump.

Connection: thanks to a reusable stainless steel connector, the diluter is aseptically connected to the bag through a septum.

There are 3 presentations: in 2 litres (one box with five bags), 3 litres (one box with 3 bags) and 5 litres one box with 2 bags).

Expiry from manufacturing date: 12 months.

Injectable rubber septum, with a cover, that connects to a gravimetric pump or dilutor to remove the inner broth or diluent.



Filling tube, which is sealed after production, ensures the air-tightness of the inner broths and diluents.



• A special hole that allows the end user to hang up the Flexibag in a gravimetric pump or dilutor.



• Ready-to-use sterile broths and diluents



Single box for 2-litres Flexibags (x5 u.) and 3 litres (x3 u.).



2 boxes for 5-litres Flexibags

Dehydrated and prepared chromogenic culture media

Microinstant® and CHROMagar™ chromogenic media

Chromogenic media are those that include chromogenic substrates in their formulation that take advantage of enzymatic reactions specific to bacteria for their differential identification by the colours of their colonies.

This group of products includes 3 different brands: Microinstant®, prepared plates of Scharlau chromogenic media, CHROMagar™, dehydrated chromogenic medium from CHROMagar™ company.

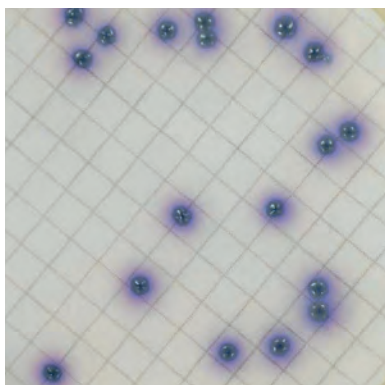

Compact Dry® dehydrated chromogenic media

Dehydrated medium plates, which can be used as standard culture plates for counting microorganisms or in contact plates for surface control (with the help of a special swab). The differentiation of the colonies is done thanks to the presence of chromogenic substrates and redox indicators. 1 ml of the sample is deposited on the plate. The liquid diffuses homogeneously on the surface of the medium. Subsequently, incubate at the temperature specified in the instructions or according to the standard applied. Compact Dry® has a shelf life of 2 years from the date of manufacture and is stored at room temperature.

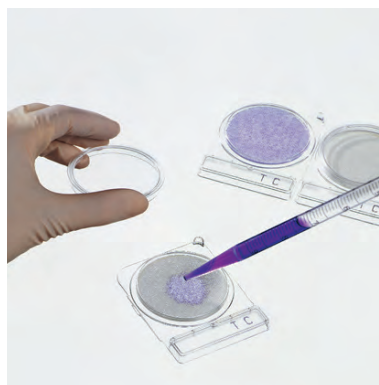

Conservation and storage of prepared media

The optimal storage temperature of prepared 90 mm plates is between 2-14°C, but in general they can be kept between 2-25°C while keeping the properties of the medium. The following precautions should always be taken:

- Between 2-8°C, avoid contact with surfaces that may freeze the product.
- Between 15-25°C, check that the plates do not dehydrate.

For other presentations of plates, tubes, flasks and bags, we recommend storage at room temperature without the need for refrigeration. Strict manufacturing processes and controls are implemented to ensure maximum quality and stability throughout the product's life cycle:

- Rigorous control of sterilization temperatures.
- Accuracy in the weighing and mixing of ingredients and media.
- Homogeneity between batches monitored.
- Control of microorganism recovery.
- Specially designed to keep optimal humidity conditions.
- Keep physical-chemical parameters: pH, colour, appearance, hydration, etc.

BACTERIAL STRAINS

MiStraCon® Microbiologic Strains for Control

MiStraCon® strains

This catalogue includes the Scharlab MiStraCon® product line of bacterial strains from the American Type Culture Collection (ATCC®) and includes the strains commonly used in the laboratory, in the food industry, pharmaceutical industry, water quality control and clinical settings.

Scharlab is authorized by the ATCC® to produce reference **ATCC Licensed Derivative**® cultures (Reference Stock Culture) of primary cultures ATCC® (Reference Culture) and is attached to the program (ATCC® Licensed Derivative® Program). The ATCC Licensed Derivative mark states that Scharlab S.L. is licensed to use these trademarks and to sell products deriving from ATCC® cultures.

All MiStraCon® products are supplied with detailed instructions for use and have an analysis certificate that guarantees their authenticity, traceability and the number of subcultures made from the original reference culture.

These product lines consist of three product formats (see next page):



Documentation



License to import medical devices for in vitro diagnostics (IVD) and accessories



Explanatory document, transport conditions for MiStraCon® strains



MiStraCon® products related in the attached document are produced in an ISO 17034:2016 accredited certified material producer, and are included within the scope of the accreditation.



MiStraCon®Swabs2 format

Non quantified bacterial strains presented in a lyophilized pellet prepared to self-hydrate and to be used directly with a hyssop incorporated in the dispositive.

Format	Packaging	Content	CFU	Applications/Specifications
MiStraCon®Swabs2 	Each unit contains a lyophilized pellet, moisturizing fluid And inoculation swab, all sealed in an aluminized envelope	2 units of MiStraCon®Swabs2	Not quantified	<ul style="list-style-type: none"> - Culture purposes - Daily QC - QC of identification systems and assay kits - QC of antimicrobial susceptibility test - Verification and validation

MiStraCon®QuantyPellets and MiStraCon®QuantyE-Pellets® formats

Quantified bacterial strains presented in a lyophilized pellet ready to use or to prepare quantified dilutions.

Format	Packaging	Content	CFU	Applications/Specifications
MiStraCon®QuantyPellets 	1 box. Each box contains 5 vials of a single quantified microorganism and 5 vials of hydrating fluid	5 vials with 1 quantified pellet (1 pellet/vial) and 5 vials of hydrating fluid (1.2 ml)	<100 by 0.1 ml when processed according to directions	<ul style="list-style-type: none"> - Growth promotion testing - Media challenge testing - Suitability of counting methods - Suitability of sterility tests - Suitability of tests for specified microorganisms - Microbial limits testing - Microbial enumeration testing - Validation of neutralization methods - Methods requiring a low CFU concentration
MiStraCon®QuantyE-Pellets 	1 vial of lyophilized pellets in a plastic bag with hermetic seal	1 vial with 5 pellets	1.0E+03 – 1.0E+07 per pellet	<ul style="list-style-type: none"> - Detection and enumeration methods - Verification/Validation - Bioburden determination - Minimal lethal concentration - Disinfectant qualification - Water tests - Proficiency tests - Methods requiring a specific CFU range

PRODUCT LABEL

Classification and labeling of products

GHS: Global Harmonized System for classification and labelling of chemical products

Each country or economic Community has its own legislation and the same substance can be classified as harmful, non-hazardous or toxic in different countries. The GHS system was born in the UN as a proposal to facilitate global trade while protecting human health and the environment, unifying the different classification criteria for dangerous substances that coexist in the world.

CLP: Classification of labeling and packaging of substances and mixtures

The European Union has adopted the GHS system through directive EC num. 1272/2008, called CLP, which came into force in the member states on January 20, 2009. This standard replaces the current classification and labelling system, defined by Directives 67/548 / EEC (DSD) and 1999/45 / EC (DPD) for substances and mixtures respectively. These two directives will be invalid as of June 1st, 2015.

The implementation of the CLP has two important dates: December 1st, 2010: Obligation to classify and label substances.

June 1st, 2015: Obligation to classify and label mixtures.

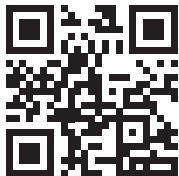

Scan the Scharlab microbiological product's QR barcode and instantly download all the documentation associated with the scanned products to your smartphone using our ScharlabQR App.

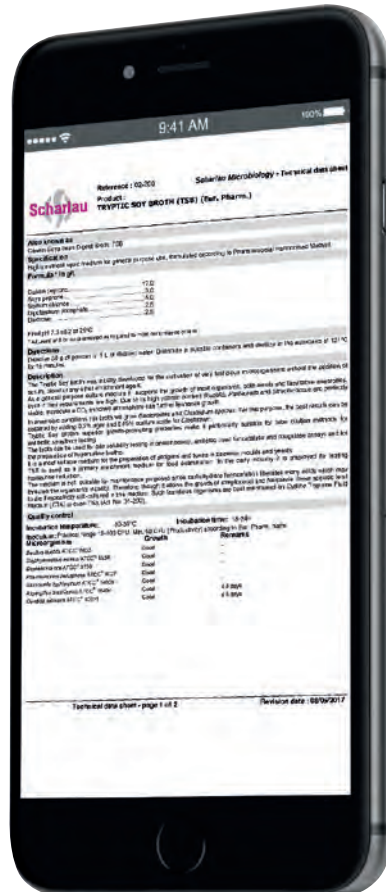

Understanding our label

As a result of the application of the CLP Directive, we have made changes to the information on our labels:

- **Pictograms.** The traditional danger symbols on an orange background are replaced by new pictograms on a white background surrounded by red frame.
- **The hazard statements (H)** replace the current risk phrases (R).
- **The precautionary statements (P)** replace the current safety phrases (S).
- **Word of warning.** The text that accompanied the pictograms, p. and “easily flammable” disappears. However, a word of caution according to the H and P statements indicate the severity of the potential hazard. This word can be “Danger” or “Warning”.



- | | |
|-------------------------------|--|
| 1 English Product name | 6 Expiry date |
| 2 Order number | 7 Storage temperature |
| 3 Composition | 8 QR code: access to TDS, CoA and MSDS |
| 4 Product name in 4 languages | 9 Preparation method in five languages |
| 5 Batch number | 10 Space for opening information |











NOTE: For toxic products, the toxicity pictograms appear at the bottom of the left side face.

SAFETY

















CLP COMPLIANCE & PRODUCT INFORMATION

CLP pictograms

NOTE: The CLP pictograms refer to dehydrated culture media, additives and supplements.

Physical hazards				
				
Explosives	Flammable liquids	Oxidizing liquids	Compressed gases	Corrosive to metals
Health hazards			Environmental hazards	
				
Acute toxicity	Skin corrosion	Skin irritation	CMR ¹⁾ , STOT ²⁾ Aspiration hazard	Hazardous to the aquatic environment
<small>¹⁾ carcinogenic, mutagenic, toxic to reproduction / ²⁾ specific target organ toxicity</small>				

Symbols

Illustrative symbols for the different culture media packaging formats	
 5 sachets of dehydrated culture medium (to make up 500 ml of prepared medium each)	 20 tubes of 10 ml / 9 ml (broth) 20 tubes of 15 ml / 10 ml (agar)
 500 g	 20 agar slant tubes
 20 plates of 90 mm	 2 L / 3 L / 5 L bag
 20 plates of 90 mm, irradiated	 Supplement LYO1 (10 vials)
 30 contact plates 24 contact plates (triple packaging)	 5 kg / 25 kg drum
 30 filtration plates (6x5) film packed	 Glass bottle
 30 filtration plates of 55 mm (RD-pack) 80 contact plates (RD-pack)	 Plastic ampoule
 10 flasks of 100 ml / 200 ml / 225 ml (broth) 1 flask of 100 ml and 1 litre (additive)	 HDPE screw-capped bottle and dropper
 10 flasks of 100 ml / 200 ml flasks (agar)	

NOTE: For dehydrated media presented in 500 g packs (□), we can offer other formats, including 5 and 25 kg packs. For more information write to: helpdesk@scharlab.com.

Meaning of reference numbers

Information coded in the reference number on the format of the product			
064-PA	90 mm plates	064PRB	80 contact plates
064-PF	Filtration plates	064-BA	Flasks
064-PR	30 contact plates	064-TA	Tubes
064-BA01-2/02/03	Flexibags	064-LYO1	Lyophilized supplements

Abbreviations

Abbreviation	Document	Institution / Organization
APHA		American Public Health Association (Washington Dc, USA)
AOAC	Official Methods of Analysis Of Aoac International	Association of Official Analytical Chemists
ASM		American Society for Microbiology (Washington dc, USA)
ASTM		American Society for Testing Materials
ATCC		American Type Culture Collection
AWWA		American Water Works Association (Washington DC, USA)
BAM	Bacteriological Analytical Manual	Food and Drug Administration (Washington Dc, Usa)
BP	British Pharmacopoeia	British Pharmacopoeia Commission, The Stationery Office (London)
CEN		Centre Europeen pour la Normalisation (Brussels)
CLSI		Clinical Laboratory Standards Institute (Vilanova, Pa, Usa)
CMPH	Clinical Microbiology Procedures Handbook	American Society for Microbiology (Asm)
COMPF	Compendium of Methods for the microbiological examination of foods	Apha
DIN		Deutsche Institut für Normung (Berlin)
EDQM		European Directorate for the Quality of Medicines
EN	European Norme	Centre Europeen pour la Normalisation (Brussels)
EP	European Pharmacopoeia 5th Ed.	Edqm (Strasbourg)
FDA		Food and Drug Administration (Washington Dc, Usa)
FIL		Federation International Laitière (Brussels)
IDF		International Dairy Federation (Brussels)
IFU	Ifu Microbiological Methods	International Federation of Fruit Juice Producers (Switzerland)
HP	Harmonised Pharmacopoeias (European, American and Japanese) European Pharmacopoeia 7th Ed.	Edqm (Strasbourg)
ISO		International Standardization Organization (Geneva, Switzerland)
NCLSS		National Committee for Clinical Laboratory Standards (Vilanova, Pa, Usa)
NMKL		Nordisk Methodenkommittee Fur Lebensmittel
SL	Schweizerisches Lebensmittelbuch (Swiss Food Manual)	Bundesamt für Gesundheit, Direktionsbereich Verbraucherschutz (Bern)
SMD	Standard Methods for the Examination of Dairy Products	Apha, (Washington Dc, Usa)
SMWW	Standard Methods for the Examination of Water and Wastewater	Apha, Awwa, Wpc
USP	United States Pharmacopoeia - National Formulary USP 28	Usp Convention Ltd. (Rockville Md, Usa)
WEF		Water Environment Federation (Washington Dc, Usa)

DEHYDRATED AND PREPARED CULTURE MEDIA

A1 BROTH

02-651
AOAC / APHA

Liquid medium for detecting faecal coliforms in water samples.

FOOD & BEVERAGES
WATER
CLINICAL
PHARMA
COSMETICS
ENVIRONMENTAL
MOLECULAR

PRESENTATION	TYPE OF PACKAGING	ART. NO.	SECTOR
500 g*		02-651-500	●

ACETAMIDE MEDIUM

03-428
DIN / EN / ISO

Liquid test medium use for the confirmation of *Pseudomonas aeruginosa* in water according to the ISO 16266 standard and UNE-EN ISO 12780.

FOOD & BEVERAGES
WATER
CLINICAL
PHARMA
COSMETICS
ENVIRONMENTAL
MOLECULAR

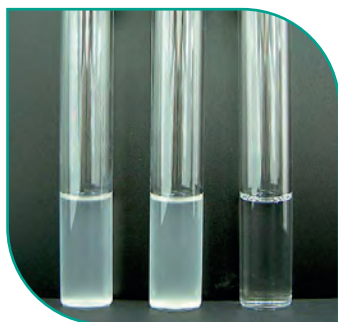

PRESENTATION	TYPE OF PACKAGING	ART. NO.	SECTOR
500 g*		03-428-500	●
5x500 ml		03-428BA05	●

ALGAE AGAR

01-007
SMWW

Solid culture medium for the isolation and cultivation of algae from soil, water and waste water.

FOOD & BEVERAGES
WATER
CLINICAL
PHARMA
COSMETICS
ENVIRONMENTAL
MOLECULAR

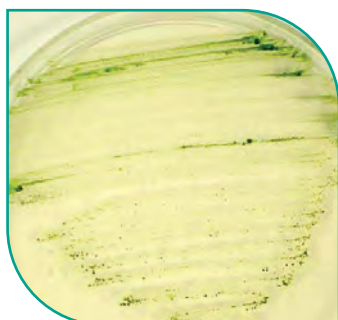

PRESENTATION	TYPE OF PACKAGING	ART. NO.	SECTOR
500 g*		01-007-500	●

ALGAE BROTH

02-007
SMWW

Nutritive solution for algae and cyanobacteria, appropriate for water algicide biotesting.

FOOD & BEVERAGES
WATER
CLINICAL
PHARMA
COSMETICS
ENVIRONMENTAL
MOLECULAR

PRESENTATION	TYPE OF PACKAGING	ART. NO.	SECTOR
500 g*	☐	02-007-500	●

ANTIBIOTIC MEDIUM A
pH 6, 6 (EUR. PHARM.)

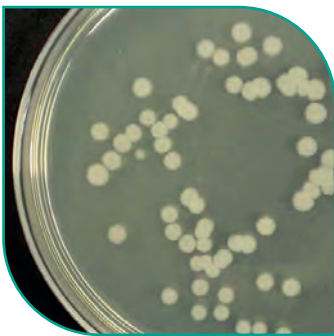

- SEED AGAR
- MEDIUM A
- PENASSAY SEED AGAR
- PENICILLIN ASSAY SPEED AGAR
- MEDIUM 1
- AM1
- ANTIBIOTIC MEDIUM 1

01-009
EP / HP / USP

Antibiotic Medium A at pH 6, 6 is used in microbiological antibiotic assays using agar diffusion technique according to European pharmacopeia 9.0.

FOOD & BEVERAGES
WATER
CLINICAL
PHARMA
COSMETICS
ENVIRONMENTAL
MOLECULAR

PRESENTATION	TYPE OF PACKAGING	ART. NO.	SECTOR
500 g*	☐	01-009-500	●
5x500 ml	☐	01-009BA05	●
20 plates of 90 mm Ø	☉	064-PA0108	●

ANTIBIOTIC MEDIUM A
pH 7, 9 (EUR. PHARM.)



- NEOMYCIN ASSAY AGAR
- ERYTHROMYCIN ASSAY AGAR
- MEDIUM C
- MEDIUM 11
- MEDIUM J
- AM11
- ANTIBIOTIC MEDIUM 11

01-017
EP / HP / USP

Antibiotic Medium A at pH 7, 9 is used in microbiological antibiotic assays using agar diffusion technique according to the methodology recommended in the pharmacopeia.

FOOD & BEVERAGES
WATER
CLINICAL
PHARMA
COSMETICS
ENVIRONMENTAL
MOLECULAR

PRESENTATION	TYPE OF PACKAGING	SPECIFICATIONS	ART. NO.	SECTOR
500 g*	☐		01-017-500	●
5x500 ml	☐		01-017BA05	●
10 flasks with 200 ml	☐	Metalic-non injectable cap	064-BA2136	●

ANTIBIOTIC MEDIUM B
(EUR. PHARM.)



- ANTIBIOTIC MEDIUM 10
- MEDIUM 10

01-016
EP / HP / ISO / USP

Antibiotic Medium B is used in the microbiological assays of Colistimethate and Polymyxin by the Agar Diffusion method according to the methodology pharmacopeias.

FOOD & BEVERAGES
WATER
CLINICAL
PHARMA
COSMETICS
ENVIRONMENTAL
MOLECULAR

PRESENTATION	TYPE OF PACKAGING	ART. NO.	SECTOR
500 g*	☐	01-016-500	●

*For dehydrated media presented in a 500 g package, we are able to offer other formats, including 5 and 25 kg. More information at: helpdesk@scharlab.com.

ANTIBIOTIC MEDIUM C (EUR. PHARM.)

➤ ANTIBIOTIC MEDIUM 3 (USP)

➤ ANTIBIOTIC ASSAY BROTH

➤ MEDIUM C

02-011
EP / HP / USP

Antibiotic Medium C may be used in the preparation of inoculum, serial dilutions or turbidimetric antibiotic assays.

PRESENTATION	TYPE OF PACKAGING	ART. NO.	SECTOR
500 g*	☐	02-011-500	●

FOOD & BEVERAGES
WATER
CLINICAL
PHARMA
COSMETICS
ENVIRONMENTAL
MOLECULAR

ANTIBIOTIC MEDIUM E (EUR. PHARM.)

01-430
EP / HP / USP / ISO

Antibiotic Medium E is used in the microbiological assays of Framycetin and Neomycin using the Agar Diffusion method according to the pharmacopeia.



PRESENTATION	TYPE OF PACKAGING	ART. NO.	SECTOR
500 g*	☐	01-430-500	●

FOOD & BEVERAGES
WATER
CLINICAL
PHARMA
COSMETICS
ENVIRONMENTAL
MOLECULAR

ANTIBIOTIC MEDIUM F (EUR. PHARM.)

➤ ANTIBIOTIC MEDIUM 19
➤ MEDIUM 19

01-434
EP / HP / ISO / USP

Antibiotic Medium F is used in the titration of antifungal antibiotics by the agar diffusion method according to the pharmacopeia.

PRESENTATION	TYPE OF PACKAGING	ART. NO.	SECTOR
500 g*	☐	01-434-500	●

FOOD & BEVERAGES
WATER
CLINICAL
PHARMA
COSMETICS
ENVIRONMENTAL
MOLECULAR

ANTIBIOTIC MEDIUM NO. 3

064-TA8313
USP

General purpose liquid medium for the direct inoculation of samples from the fermentation tanks.



ANTIBIOTIC MEDIUM NO. 3 WITHOUT PHENOL RED

PRESENTATION	TYPE OF PACKAGING	SPECIFICATIONS	ART. NO.	SECTOR
100 tubes with 10 ml	☐	Threaded needle tube	064-TA8313	●

FOOD & BEVERAGES
WATER
CLINICAL
PHARMA
COSMETICS
ENVIRONMENTAL
MOLECULAR

ANTIBIOTIC MEDIUM NO. 3 WITH PHENOL RED

PRESENTATION	TYPE OF PACKAGING	SPECIFICATIONS	ART. NO.	SECTOR
20 tubes with 9 ml	☐	Threaded needle tube	064-TA8317	●
100 tubes with 10 ml	☐	Threaded needle tube	064-TA8314	●

FOOD & BEVERAGES
WATER
CLINICAL
PHARMA
COSMETICS
ENVIRONMENTAL
MOLECULAR

ANTIBIOTIC MEDIUM NO. 8



01-014
USP

Solid medium for the antibiotic assay by the agar diffusion method.

PRESENTATION	TYPE OF PACKAGING	ART. NO.	SECTOR
500 g*	☐	01-014-500	● FOOD & BEVERAGES ● WATER ● CLINICAL ● PHARMA ● COSMETICS ● ENVIRONMENTAL ● MOLECULAR

APT AGAR



➤ ALL PURPOSE POLYSORBATE AGAR

➤ ALL PURPOSE TWEEN® AGAR

01-026
COMPF

Solid medium for general purpose use, especially designed for the cultivation of the heterofermentative lactic acid bacteria that cause greening of meat.

PRESENTATION	TYPE OF PACKAGING	ART. NO.	SECTOR
500 g*	☐	01-026-500	● FOOD & BEVERAGES ● WATER ● CLINICAL ● PHARMA ● COSMETICS ● ENVIRONMENTAL ● MOLECULAR

ARGININE GLUCOSE AGAR

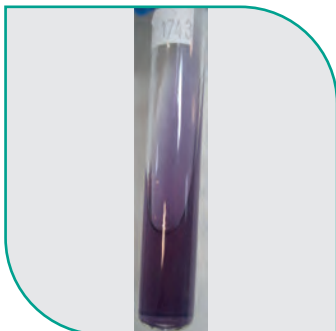

➤ AGS

01-743
ISO

Diferential solid medium used for the presuntive identification of *Vibrio spp* according to ISO standards 21872-1 and 21872-2.

PRESENTATION	TYPE OF PACKAGING	ART. NO.	SECTOR
500 g*	☐	01-743-500	● FOOD & BEVERAGES ● WATER ● CLINICAL ● PHARMA ● COSMETICS ● ENVIRONMENTAL ● MOLECULAR

ASPARAGINE BROTH



02-271

Liquid medium for assay and enumeration of presumptive *Pseudomonas aeruginosa* in bottled water by MPN Method.

PRESENTATION	TYPE OF PACKAGING	ART. NO.	SECTOR
500 g*	☐	02-271-500	● WATER ● CLINICAL ● PHARMA ● COSMETICS ● ENVIRONMENTAL ● MOLECULAR
5x500 ml	☐	02-271BA05	● WATER ● CLINICAL ● PHARMA ● COSMETICS ● ENVIRONMENTAL ● MOLECULAR



*For dehydrated media presented in a 500 g package, we are able to offer other formats, including 5 and 25 kg. More information at: helpdesk@scharlab.com.

AZIDE DEXTROSE BROTH (ROTHER)

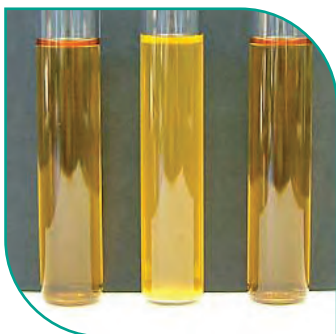

02-027
COMPF

Medium for the detection and enumeration of enterococci in water.

PRESENTATION	TYPE OF PACKAGING	SPECIFICATIONS	ART. NO.	FOOD & BEVERAGES	WATER	CLINICAL	PHARMA	COSMETICS	ENVIRONMENTAL	MOLECULAR
500 g*	☐		02-027-500	●			●			
20 tubes with 9 ml	↑	Ink labelled tubes and metallic cap	064-TA0158	●	●		●			

AZIDE ETHYL VIOLET BROTH (EVA BROTH)

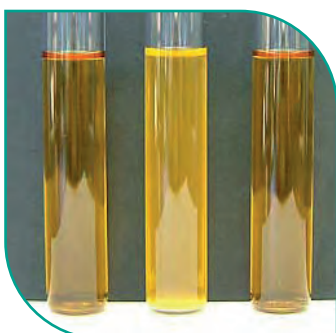

➤ LITSKY BROTH

➤ ETHYL VIOLET AZIDE BROTH (EVA BROTH)

➤ EVA BROTH

02-028
COMPF / SMWW

Liquid medium for the confirmation of enterococci in water.

PRESENTATION	TYPE OF PACKAGING	ART. NO.	FOOD & BEVERAGES	WATER	CLINICAL	PHARMA	COSMETICS	ENVIRONMENTAL	MOLECULAR
500 g*	☐	02-028-500		●					

BACILLUS CEREUS AGAR

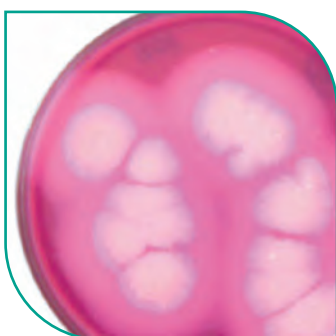

➤ MANNITOL-EGG YOLK-POLYMYXIN AGAR

➤ MYP AGAR

01-262
COMPF / FIL-IDF / ISO

Selective solid medium, according to Mossel, for the isolation and identification of *Bacillus cereus* from food samples according to ISO standards 7932 and 21871. This medium needs add 100 ml of Egg Yolk Sterile Emulsion (Art. No. 06-016) and 100 mg/l of Polymyxin (Art. No. 06-021LYO1).

PRESENTATION	TYPE OF PACKAGING	SPECIFICATIONS	ART. NO.	FOOD & BEVERAGES	WATER	CLINICAL	PHARMA	COSMETICS	ENVIRONMENTAL	MOLECULAR
500 g*	☐		01-262-500	●		●				
5x500 ml	☐		01-262BA05	●		●				
20 plates of 90 mm Ø	⊙		064-PA0032	●		●				
10 flasks with 90 ml	☒	Metalic-non injectable cap	064-BA2129	●		●				
Polymyxin B sulfate Selective Supplement. 10 vials	☒		06-021LYO1	●		●				
Egg's yolk sterile emulsion (Additive). 100 ml flasks	☒		06-016-100	●		●				

**BACILLUS CEREUS
SELECTIVE AGAR**

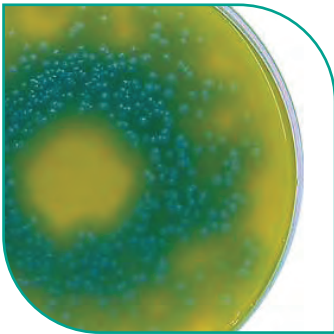

► PEMBA (POLYMYXIN-EGG YOLK-MANITOL-BLUE-AGAR)

**01-487
FIL-IDF / ISO / NKML**

Selective solid medium for the enumeration of *Bacillus cereus* in food, according to ISO 21871 and NMKL 674 standards. This medium needs add 50 ml/L of Egg Yolk Sterile Emulsion (Art. No. 06-016) and 2 vials/litre of Polymyxin B Sulfate (Art. No. 06-021LYO1).

PRESENTATION	TYPE OF PACKAGING	ART. NO.	FOOD & BEVERAGES	WATER	CLINICAL	PHARMA	COSMETICS	ENVIRONMENTAL	MOLECULAR
500 g*	☐	01-487-500	●						
5x500 ml	☐	01-487BA05	●						
Polymyxin B sulfate Selective Supplement. 10 vials	☐	06-021LYO1	●		●				
Egg's yolk sterile emulsion (Additive). 100 ml flasks	☐	06-016-100	●		●				

**BAIRD PARKER
AGAR BASE**

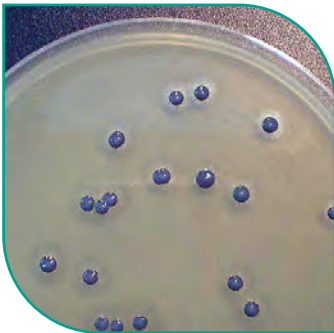

► BP AGAR
► EGG YOLK TELLURITE GLYCINE PIRUVATE AGAR

► ETGP AGAR
► MEDIUM O EUR. PHARM. 5TH ED.

**01-030
BAM / EP / ISO / USP**

Solid and selective culture medium for the screening of staphylococci from a variety of samples, according to pharmacopeias and ISO 5944, 6888-1 and 22718 standards. This medium needs add 50 ml of Egg Yolk Tellurite Sterile Emulsion (Art. No. 06-026-100 with NaCl or 064-BA1018 without NaCl).

PRESENTATION	TYPE OF PACKAGING	SPECIFICATIONS	ART. NO.	FOOD & BEVERAGES	WATER	CLINICAL	PHARMA	COSMETICS	ENVIRONMENTAL	MOLECULAR
500 g*	☐		01-030-500	●		●	●	●	●	
5x500 ml	☐		01-030BA05	●		●	●	●	●	
20 plates of 90 mm Ø	☐		064-PA0008	●		●	●	●	●	
30 contact plates	☐		064-PR0008	●		●	●	●	●	
30 plates of 55 mm Ø	☐	Triple packaging	064-PF6030	●		●	●	●	●	
10 flasks with 90 ml	☐	Non injectable cap	064-BA1033	●		●	●	●	●	
Egg's Yolk Tellurite Sterile Emulsion (Additive). 100 ml flasks	☐	Injectable cap: Plastic screw inner cap + elastomer septum + protective outer cap. According to ISO standards	064-BA1018	●		●	●	●	●	
Egg's Yolk Tellurite Sterile Emulsion (Additive). 100 ml flasks	☐	Injectable cap: Plastic screw inner cap + elastomer septum + protective outer cap	06-026-100	●		●	●	●	●	

BAIRD PARKER RPF AGAR

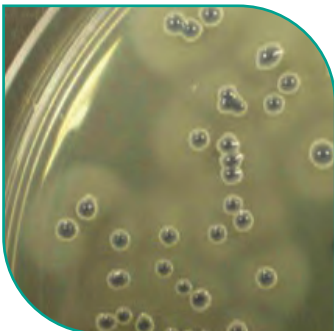

**064-PA0145
EP / FIL-IDF / ISO / USP**

Solid culture medium for the enumeration of coagulase-positive staphylococci in food and in the control of food processors. According to ISO 5944, 6888-1 and 22718. Add to each flasks of medium base 1 vial re-suspended in distilled water with 10 ml of RPF (Art. No. 064-TA0155).

PRESENTATION	TYPE OF PACKAGING	SPECIFICATIONS	ART. NO.	FOOD & BEVERAGES	WATER	CLINICAL	PHARMA	COSMETICS	ENVIRONMENTAL	MOLECULAR
500 g*	☐		01-030-500	●		●	●	●	●	
20 plates of 90 mm Ø	☐		064-PA0145	●		●	●	●	●	
(Base medium) 10 flasks with 90 ml	☐	Metalic-non injectable cap	064-BA1028	●		●	●	●	●	
10 flasks with 180 ml	☐	Metalic-non injectable cap	064-BA7038	●		●	●	●	●	
RPF Lyophilized Supplement. 10 tubes with 9 ml	☐	White plastic cap	064-TA0155	●		●	●	●	●	

*For dehydrated media presented in a 500 g package, we are able to offer other formats, including 5 and 25 kg. More information at: helpdesk@scharlab.com.

BAT AGAR

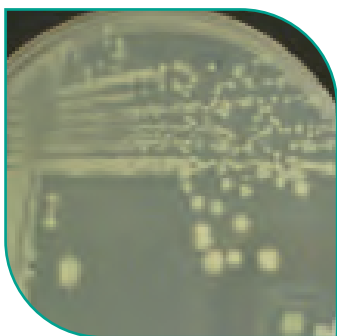

01-675
IFU

Solid medium for the detection and isolation of *Alicyclobacillus*, in fruit juices and other acidic food, according to IFU standard method No. 12. For detection of the species *A. acidoterrestris* recommend using the K Agar medium (Art. No. 01-674).

PRESENTATION	TYPE OF PACKAGING	ART. NO.	FOOD & BEVERAGES	WATER	CLINICAL	PHARMA	COSMETICS	ENVIRONMENTAL	MOLECULAR
500 g*	☐	01-675-500	●						
5x500 ml	☐	01-675BA05	●						

BAT BROTH



02-675
IFU

Liquid medium used for the enrichment of *Alicyclobacillus*, from fruit juices and other acidic foods, according to IFU standard method No. 12. For detection of the species *A. acidoterrestris* recommend using the K Agar medium (Art. No. 01-674).

PRESENTACIÓN	TYPE OF PACKAGING	ART. NO.	FOOD & BEVERAGES	WATER	CLINICAL	PHARMA	COSMETICS	ENVIRONMENTAL	MOLECULAR
500 g*	☐	02-675-500	●						
5x500 ml	☐	02-675BA05	●						

BCSA, see *BURKHOLDERIA CEPACIA* SELECTIVE AGAR BASE, page 51

BCYE LEGIONELLA AGAR BASE



► CYE

01-687
ISO / SMWW

Solid medium base used for the detection, isolation and enumeration of *Legionella* from water according to the ISO standards 11731 and 11731-2. Needs Legionella BCYE Growth Supplement (Art. No. 06-137LYO1).

► See Legionella Selective (GVPC) Agar (ISO), page 73.

PRESENTATION	TYPE OF PACKAGING	ART. NO.	FOOD & BEVERAGES	WATER	CLINICAL	PHARMA	COSMETICS	ENVIRONMENTAL	MOLECULAR
500 g*	☐	01-687-500		●	●			●	
5x500 ml	☐	01-687BA05		●	●			●	
20 plates of 90 mm Ø	☉	064-PA0069		●	●			●	
Legionella BCYE Growth Supplement. 5 vials + 5 vials of solvent	☞	06-137LY01		●	●			●	

BCYE LEGIONELLA SELECTIVE, see LEGIONELLA SELECTIVE (GVPC) AGAR (ISO), page 73

BCYE LEGIONELLA WITHOUT CYSTEINE

► CYE W/O CYS

064-PA6001 ISO

Selective medium for the study of *Legionella* formulated according to ISO 11731. Needs Legionella BCYE without Cysteine Supplement (Art. No. 06-134LYO1).

Medium used in the characterization of *Legionella* based on the absence of growth of these microorganisms by their dependence on Cysteine.

PRESENTATION	TYPE OF PACKAGING	ART. NO.	SECTOR						
			FOOD & BEVERAGES	WATER	CLINICAL	PHARMA	COSMETICS	ENVIRONMENTAL	MOLECULAR
500 g*	☐	01-687-500	●	●				●	
5x500 ml	☐	01-687BA05	●	●				●	
20 plates of 90 mm Ø	☉	064-PA6001	●	●				●	
Legionella BCYE w/o cysteine. No growth supplement. 5 vials + 5 vials of solvent	☐	06-134LYO1	●	●				●	

BCYE+AB LEGIONELLA SELECTIVE AGAR (ISO)



064-PA6090 ISO

Solid medium base used for the detection, isolation and enumeration of *Legionella* from water according to the ISO standards 11731.

PRESENTATION	TYPE OF PACKAGING	ART. NO.	SECTOR						
			FOOD & BEVERAGES	WATER	CLINICAL	PHARMA	COSMETICS	ENVIRONMENTAL	MOLECULAR
20 plates of 90 mm Ø	☉	064-PA6090	●	●				●	

BEA, see BILE ESCULIN AZIDE AGAR, page 44

BEERENS COSMETIC DILUENT



02-257

Diluent used to neutralize preservative systems in routine examination of cosmetic products. Dehydrated medium needs add Polysorbate 80 (Art. No. TW0080).

PRESENTATION	TYPE OF PACKAGING	SPECIFICATIONS	ART. NO.	SECTOR						
				FOOD & BEVERAGES	WATER	CLINICAL	PHARMA	COSMETICS	ENVIRONMENTAL	MOLECULAR
500 g*	☐		02-257-500						●	
5x500 ml	☐		02-257BA05						●	
10 flasks with 90 ml	☐	Injectable plastic cap	064-BA2022				●	●		
10 flasks with 100 ml	☐	Injectable plastic cap	064-BA1022				●	●		
20 tubes with 9 ml	☐	Ink labelled tubes and metallic cap	064-TA2022				●	●		
Polysorbate 80 (Additive). 100 ml	☐		TW00800100						●	

BGA, see BRILLIANT GREEN AGAR, page 46



*For dehydrated media presented in a 500 g package, we are able to offer other formats, including 5 and 25 kg. More information at: helpdesk@scharlab.com.

BGA MODIFIED, see BRILLIANT GREEN MODIFIED AGAR, page 47

BGBL, see BRILLIANT GREEN BILE 2%, page 47

BHI AGAR, see BRAIN HEART INFUSION AGAR, page 45

BHI BROTH, see BRAIN HEART INFUSION BROTH, page 46





BIGGY AGAR, see NICKERSON AGAR, page 88

BILE ESCULIN AZIDE AGAR

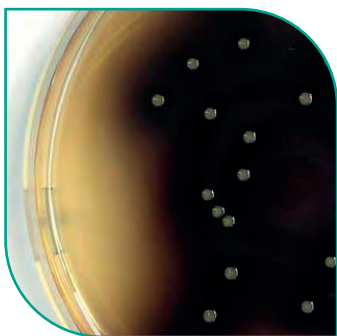
01-592
BAM / ISO

Solid medium for the confirmation and enumeration of enterococci in clinical samples and water samples by the membrane filtration method according to ISO 7899-2 standard.



PRESENTATION	TYPE OF PACKAGING	SPECIFICATIONS	ART. NO.	FOOD & BEVERAGES	WATER	CLINICAL	PHARMA	COSMETICS	ENVIRONMENTAL	MOLECULAR
500 g*			01-592-500	●	●					
5x500 ml			01-592BA05	●	●					
20 plates of 90 mm Ø			064-PA3134	●	●					
30 plates of 55 mm Ø			064-PF0008	●	●					
10 flasks with 100 ml		Metalic-non injectable cap	064-BA0008	●	●					



BILE ESCULIN MODIFIED AGAR

► BILE ESCULIN MEDIUM ► BEM ► BILE ESCULIN AGAR

01-265
BAM / COMPF / ISO

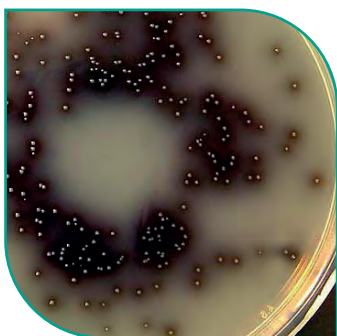
Solid culture medium for identification of probiotic streptococci in food samples.







PRESENTATION	TYPE OF PACKAGING	SPECIFICATIONS	ART. NO.	FOOD & BEVERAGES	WATER	CLINICAL	PHARMA	COSMETICS	ENVIRONMENTAL	MOLECULAR
500 g*			01-265-500	●						
5x500 ml			01-265BA05	●						
20 tubes with 6.2 ml of slanted agar		Ink labelled tubes and metallic cap	064-TA0102	●	●					

BLOOD AGAR BASE

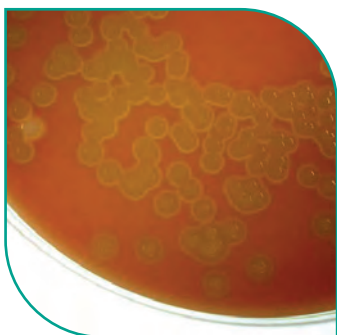
01-352

Nutrient rich medium suitable for the isolation of pathogenic microorganisms from clinical specimens. This medium needs to add Ampicillin Selective Supplement (Art. No. 06-126LYO1).



PRESENTATION	TYPE OF PACKAGING	ART. NO.	FOOD & BEVERAGES	WATER	CLINICAL	PHARMA	COSMETICS	ENVIRONMENTAL	MOLECULAR
500 g*		01-352-500	●		●				
5x500 ml		01-352BA05	●		●				
Ampicillin Selective Supplement		06-126LYO1	●		●				

 *For dehydrated media presented in a 500 g package, we are able to offer other formats, including 5 and 25 kg. More information at: helpdesk@scharlab.com.

BLOOD AGAR BASE (COLUMBIA)

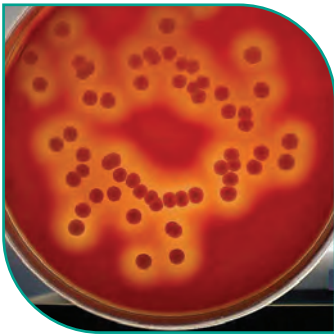

► CA ► C AGAR ► COLUMBIA BLOOD AGAR ► CB AGAR

01-034

Nutrient rich medium suitable for the isolation of pathogenic microorganisms from clinical specimens. This medium needs to add Ampicillin Selective Supplement (Art. No. 06-126LYO1).

PRESENTATION	TYPE OF PACKAGING	ART. NO.	FOOD & BEVERAGES	WATER	CLINICAL	PHARMA	COSMETICS	ENVIRONMENTAL	MOLECULAR
500 g*	☐	01-034-500			●				
5x500 ml	☐	01-034BA05			●				
20 plates of 90 mm Ø	☉	064-PA0004	●		●	●			
Ampicillin Selective Supplement	☐	06-126LY01			●				

BLOOD AGAR BASE MODIFIED



01-689

Culture medium developed specially to manufacture plates with blood.

PRESENTATION	TYPE OF PACKAGING	ART. NO.	FOOD & BEVERAGES	WATER	CLINICAL	PHARMA	COSMETICS	ENVIRONMENTAL	MOLECULAR
500 g*	☐	01-689-500			●				

BLOOD AGAR BASE NO. 2



01-505

APHA / BAM / COMPF / FDA / ISO

Nutrient rich medium suitable for the isolation of pathogenic microorganisms from clinical specimens according to ISO 7932 and 11290-1 standard.

► This medium needs addition of Blood.

PRESENTATION	TYPE OF PACKAGING	ART. NO.	FOOD & BEVERAGES	WATER	CLINICAL	PHARMA	COSMETICS	ENVIRONMENTAL	MOLECULAR
500 g*	☐	01-505-500	●		●				
5x500 ml	☐	01-505BA05	●		●				
20 plates of 90 mm Ø	☉	064-PA9997	●		●				

BOLTON ENRICHMENT BROTH BASE

02-688

BAM / ISO

Liquid culture medium used for the enrichment of *Campylobacter* from food samples according to ISO 10272-1 standard. This medium needs add Campylobacter Bolton Selective Supplement (Art. No. 06-131LYO1) and lysed horse blood (Art. No. 000SR0048C).

PRESENTATION	TYPE OF PACKAGING	SPECIFICATIONS	ART. NO.	FOOD & BEVERAGES	WATER	CLINICAL	PHARMA	COSMETICS	ENVIRONMENTAL	MOLECULAR
500 g*	☐		02-688-500	●						
10 flasks with 250 ml	☐	Injectable cap: Plastic screw inner cap + elastomer septum + protective outer cap	064-BA8055	●						
Campylobacter Bolton Selective Supplement. 10 vials	☐		06-131LY01	●						



*For dehydrated media presented in a 500 g package, we are able to offer other formats, including 5 and 25 kg. More information at: helpdesk@scharlab.com.

BRAIN HEART INFUSION AGAR (BHI AGAR)



► BHI AGAR

01-599

COMPF / DIN / FDA / ISO / SMWW

General purpose solid medium for fastidious pathogenic microorganisms.

PRESENTATION	TYPE OF PACKAGING	ART. NO.	FOOD & BEVERAGES	WATER	CLINICAL	PHARMA	COSMETICS	ENVIRONMENTAL	MOLECULAR
500 g*	☐	01-599-500	●	●				●	
5x500 ml	☐	01-599BA05	●	●				●	

BRAIN HEART INFUSION BROTH (BHI BROTH)

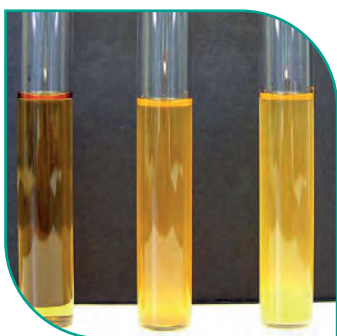

► BHI BROTH

02-599

BAM / COMPF / ISO / SMWW

Nutrient rich medium suitable for the isolation of pathogenic microorganisms from clinical specimens according to ISO 5944 standard.

PRESENTATION	TYPE OF PACKAGING	SPECIFICATIONS	ART. NO.	FOOD & BEVERAGES	WATER	CLINICAL	PHARMA	COSMETICS	ENVIRONMENTAL	MOLECULAR
500 g*	☐		02-599-500	●	●	●				
5x500 ml	☐		02-599BA05	●	●	●				
10 flasks with 100 ml	☐	Metalic-non injectable cap	064-BA6079	●	●	●		●		
20 tubes with 10 ml	☐	Ink labelled tubes and metalic-non injectable cap	064-TA0143	●	●	●				

BRAIN HEART INFUSION (BHI) SUPPLEMENTED WITH SPS (0.05%)

064-BA7083

Culture media for the qualitative detection of microorganisms in blood samples.

PRESENTATION	TYPE OF PACKAGING	SPECIFICATIONS	ART. NO.	FOOD & BEVERAGES	WATER	CLINICAL	PHARMA	COSMETICS	ENVIRONMENTAL	MOLECULAR
10 flasks with 70 ml	☐	Injectable cap: Plastic screw inner cap + elastomer septum + protective outer cap + shrink wrapped plastic sleeve	064-BA7083			●				

BRETTANOMYCES AGAR

01-816

Solid culture medium for the differential isolation of *Brettanomyces* spp. from spoiled wines.

PRESENTATION	TYPE OF PACKAGING	ART. NO.	FOOD & BEVERAGES	WATER	CLINICAL	PHARMA	COSMETICS	ENVIRONMENTAL	MOLECULAR
500 g*	☐	01-816-500	●						



*For dehydrated media presented in a 500 g package, we are able to offer other formats, including 5 and 25 kg. More information at: helpdesk@scharlab.com.

BRILLIANT GREEN AGAR (BGA)

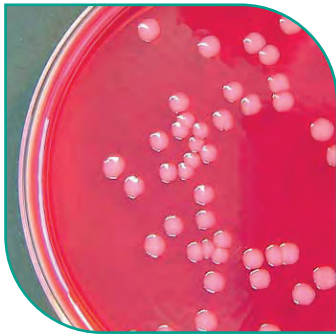

- BRILLIANT GREEN PHENOL RED LACTOSE AGAR
- BPLA

- BGA
- MEDIUM L EUR. PHARM. 5TH ED.

01-203 APHA / EP / USP

Medium for *Salmonella* isolation, according to the European Pharmacopoeia.

PRESENTATION	TYPE OF PACKAGING	ART. NO.	FOOD & BEVERAGES	WATER	CLINICAL	PHARMA	COSMETICS	ENVIRONMENTAL	MOLECULAR
500 g*	☐	01-203-500	●	●	●	●	●	●	●
5x500 ml	☐	01-203BA05	●	●	●	●	●	●	●
20 plates of 90 mm Ø	☉	064-PA0045	●	●	●	●	●	●	●

BRILLIANT GREEN BILE 2% BROTH

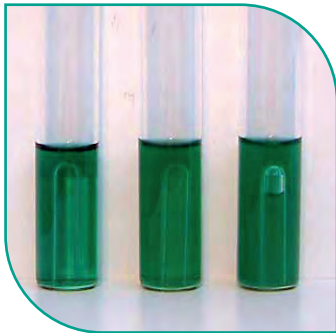

- BGBLB
- BLBVB
- BGBL BROTH

02-041 AOAC / APHA / BAM / COMPF / ISO / SMWW

Liquid medium used for the detection of coliforms in water, as recommended by APHA and ISO 4831 and 9308-1 standards.

PRESENTATION	TYPE OF PACKAGING	SPECIFICATIONS	ART. NO.	FOOD & BEVERAGES	WATER	CLINICAL	PHARMA	COSMETICS	ENVIRONMENTAL	MOLECULAR
500 g*	☐		02-041-500	●	●	●	●	●	●	●
5x500 ml	☐		02-041BA05	●	●	●	●	●	●	●
20 tubes with 9 ml	☐	Ink labelled tubes and metallic-non injectable cap, with Durham tubes	064-TA0152	●	●	●	●	●	●	●
20 tubes with 10 ml	☐	Ink labelled tubes and metallic-non injectable cap, with Durham tubes	064-TA0151	●	●	●	●	●	●	●
20 tubes with 10 ml	☐	Ink labelled tubes and metallic cap, double concentration with Durham tubes	064-TA0179	●	●	●	●	●	●	●

BRILLIANT GREEN MODIFIED AGAR



- BGA MODIFIED

01-309 DIN / IDF / ISO

Solid culture medium for selective isolation of *Salmonellae* in food (except *S. typhi*) according to ISO 6340, 6785 and IDF 93 standards.

PRESENTATION	TYPE OF PACKAGING	ART. NO.	FOOD & BEVERAGES	WATER	CLINICAL	PHARMA	COSMETICS	ENVIRONMENTAL	MOLECULAR
500 g*	☐	01-309-500	●	●	●	●	●	●	●
5x500 ml	☐	01-309BA05	●	●	●	●	●	●	●

BRUCELLA FARRELL AGAR (MODIFIED)



064-PA6113

Medium for the isolation and identification of *Brucella spp.*, from clinical specimens or foods of animal origin.

PRESENTATION	TYPE OF PACKAGING	ART. NO.	FOOD & BEVERAGES	WATER	CLINICAL	PHARMA	COSMETICS	ENVIRONMENTAL	MOLECULAR
20 plates of 90 mm Ø	☞	064-PA6113	●		●				

BUFFER PHOSPHATE pH 7.2 (0.05M)



EP / USP

Phosphate buffer used in the preparation of dilution banks for use in microbiological testing according to European Pharmacopoeia 9.0 and USP 33-NF 28.

PRESENTATION	TYPE OF PACKAGING	SPECIFICATIONS	ART. NO.	FOOD & BEVERAGES	WATER	CLINICAL	PHARMA	COSMETICS	ENVIRONMENTAL	MOLECULAR
10 flasks with 90 ml	☞	Metalic-non injectable cap	064-BA8073				●	●		

BUFFER PHOSPHATE pH 7.2 (0.05M) + 4% POLYSORBATE

PRESENTATION	TYPE OF PACKAGING	SPECIFICATIONS	ART. NO.	FOOD & BEVERAGES	WATER	CLINICAL	PHARMA	COSMETICS	ENVIRONMENTAL	MOLECULAR
10 flasks with 90 ml	☞	Metalic-non injectable cap	064-BA8074				●	●		

BUFFERED PEPTONE PHOSPHATE WATER

**02-568
SL**

Liquid non-selective pre-enrichment medium for *Enterobacteriaceae* according to Swiss food standards (formulation Schweizerisches Lebensmittelbuch).

PRESENTATION	TYPE OF PACKAGING	ART. NO.	FOOD & BEVERAGES	WATER	CLINICAL	PHARMA	COSMETICS	ENVIRONMENTAL	MOLECULAR
500 g*	☐	02-568-500	●						
10 flasks of 225 ml	☞	0000094217	●						

BUFFERED PEPTONE WATER (EUR. PHARM.) + 0.1% HISTIDIN + 0.3% LECITHIN + 3% POLYSORBATE 80



064-BA8051

EP / ISO / USP

Diluent for the homogenization of samples for the microbiological examination according to the European Pharmacopoeial Harmonised Method and ISO 21149 standard.

PRESENTATION	TYPE OF PACKAGING	SPECIFICATIONS	ART. NO.	FOOD & BEVERAGES	WATER	CLINICAL	PHARMA	COSMETICS	ENVIRONMENTAL	MOLECULAR
10 flasks with 90 ml in 125 ml	☞	Metalic-non injectable cap	064-BA8054				●	●		
10 flasks with 90 ml in 250 ml	☞	Metalic-non injectable cap	064-BA8081				●	●		
10 flasks with 300 ml	☞	Injectable cap: Plastic screw inner cap + elastomer septum + protective outer cap	064-BA8051				●	●		
9 flasks with 900 ml	☞	Non injectable cap	064-FP0002				●	●		

BUFFERED PEPTONE WATER (ISO)

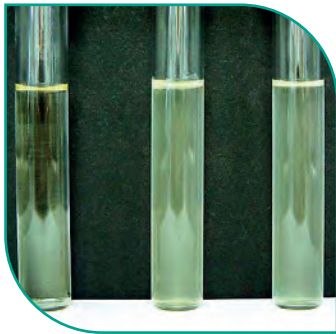

► TRYPTONE BUFFERED PEPTONE

**02-277
ISO**

Dilution and non-selective pre-enrichment liquid medium according to ISO standards 6579, 6785, 6887, 8261 and 22964.

► **You must use connector (Art. No. 064-V70815) for bags.

PRESENTATION	TYPE OF PACKAGING	SPECIFICATIONS	ART. NO.	FOOD & BEVERAGES	WATER	CLINICAL	PHARMA	COSMETICS	ENVIRONMENTAL	MOLECULAR
500 g*	☐		02-277-500	●		●				
5x500 ml	☐		02-277BA05	●		●				
5 bags of 2 litres**	☐		064-BA01-2	●		●				
3 bags of 3 litres**	☐		064-BA01-3	●		●				
2 bags of 5 litres**	☐		064-BA01-5	●		●				
10 flasks with 90 ml	☐	Injectable cap: Plastic screw inner cap + elastomer septum +protective outer cap	064-BA4010	●		●				
10 flasks with 100 ml	☐	Metalic-non injectable cap	064-BA0486	●		●				
10 flasks with 200 ml	☐	Injectable cap: Plastic screw inner cap + elastomer septum +protective outer cap	064-BA6000	●		●				
10 flasks with 225 ml in 500 ml flasks	☐	Injectable cap: Plastic screw inner cap + elastomer septum +protective outer cap	064-BA6011	●		●				
10 flasks with 225 ml in flasks of 250 ml	☐	Metalic-non injectable cap	064-BA6012	●		●				
6 flasks with 800 ml	☐	Injectable cap: Plastic screw inner cap + elastomer septum +protective outer cap	064-BA8043	●		●				
20 tubes with 9 ml	☐	Ink labelled tubes and metalic cap	064-TA0100	●		●				

BUFFERED PEPTONE WATER + 0.2% POLYSORBATE 80

PRESENTATION	TYPE OF PACKAGING	SPECIFICATIONS	ART. NO.	FOOD & BEVERAGES	WATER	CLINICAL	PHARMA	COSMETICS	ENVIRONMENTAL	MOLECULAR
10 flasks with 225 ml in flasks of 250 ml	☐	Metalic-non injectable cap	064-BA8080	●						

READY-TO-USE BROTHS & DILUENTS IN FLEXIBAGS

Suitable presentation for gravimetric dilutors

- Safe packaging
- Avoid time-consuming preparation



Download here the brochure



BUFFERED PEPTONE WATER 0.1% (EUR. PHARM.)



- BUFFERED SODIUM CHLORIDE PEPTONE SOLUTION pH 7,0
- BUFFERED PEPTONE WATER 0.1%

- BUFFERED SALINE PEPTONE WATER
- MEDIUM A EUR. PHARM. 5TH ED.

02-494
EP / HP / ISO

Diluent for the homogenization of samples for the microbiological examination according to Harmonised European Pharmacopeia method 9.0 and ISO 21149 standard.

PRESENTATION	TYPE OF PACKAGING	SPECIFICATIONS	ART. NO.	SECTOR							
				FOOD & BEVERAGES	WATER	CLINICAL	PHARMA	COSMETICS	ENVIRONMENTAL	MOLECULAR	
500 g*	📦		02-494-500	●							
5x500 ml	📦		02-494BA05	●							
10 flasks with 25 ml	🧴	Injectable cap: Plastic screw inner cap + elastomer septum + protective outer cap + shrink wrapped plastic sleever	064-V00099	●							
10 flasks with 90 ml	🧴	Injectable cap: Plastic screw inner cap + elastomer septum + protective outer cap + shrink wrapped plastic sleever	064-BA6064	●							
10 flasks with 100 ml	🧴	Injectable cap: Plastic screw inner cap + elastomer septum + protective outer cap + shrink wrapped plastic sleever	064-BA3021	●							
10 flasks with 125 ml	🧴	Metalic-non injectable cap	064-BA8059	●							
10 flasks with 200 ml	🧴	Injectable cap: Plastic screw inner cap + elastomer septum + protective outer cap + shrink wrapped plastic sleever	064-BA6062	●							
10 flasks with 225 ml	🧴	Injectable cap: Plastic screw inner cap + elastomer septum + protective outer cap	064-BA6063	●							
10 flasks with 300 ml	🧴	Injectable cap: Plastic screw inner cap + elastomer septum + protective outer cap	064-BA7071	●							
10 flasks with 500 ml	🧴	Injectable cap: Plastic screw inner cap + elastomer septum + protective outer cap + shrink wrapped plastic sleever	064-BA3043	●							
6 flasks with 800 ml	🧴	Metalic-non injectable cap	064-BA8057	●							
6 flasks with 850 ml + double bag ESTERIPAPEL®	🧴	Injectable cap: Plastic screw inner cap + elastomer septum + protective outer cap	064-BA8056	●							
20 tubes with 9 ml	🧴	Ink labelled tubes and metallic cap	064-TA2151	●							
20 tubes with 10 ml	🧴	Ink labelled tubes and metallic cap	0TA2151-10	●							

BUFFERED PEPTONE WATER + POLYSORBATE 80

PRESENTATION	TYPE OF PACKAGING	SPECIFICATIONS	ART. NO.	SECTOR							
				FOOD & BEVERAGES	WATER	CLINICAL	PHARMA	COSMETICS	ENVIRONMENTAL	MOLECULAR	
10 flasks with 100 ml	🧴	Injectable cap: Plastic screw inner cap + elastomer septum + protective outer cap + shrink wrapped plastic sleever	064-BA0003	●							
10 flasks with 90 ml	🧴	Non injectable-metal cap	064-BA8078	●							

BUFFERED PEPTONE WATER MODIFIED

064-BA2135
EP / ISO / USP

Diluent for the homogenization of samples according to ISO 21149 standard, European Pharmacopoeia 9.0 and USP 33-NF 28.

PRESENTATION	TYPE OF PACKAGING	SPECIFICATIONS	ART. NO.	SECTOR
10 flasks with 200 ml		Metallic-non injectable cap	064-BA2135	FOOD & BEVERAGES WATER CLINICAL PHARMA COSMETICS ENVIRONMENTAL MOLECULAR





BURKHOLDERIA CEPACIA SELECTIVE AGAR BASE (BCSA)

► BCSA

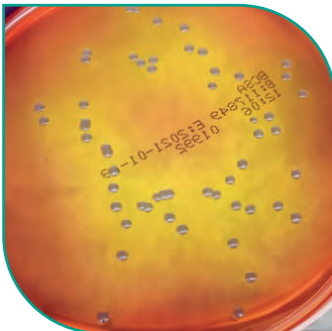
01-736
USP

Solid medium for the selective isolation of *Burkholderia cepacia* complex from the respiratory secretions of cystic fibrosis patients. Needs *Burkholderia cepacia* Selective Supplement (BCSA) (Art. No. 06-737LY01).



PRESENTATION	TYPE OF PACKAGING	ART. NO.	SECTOR
500 g*		01-736-500	FOOD & BEVERAGES WATER CLINICAL PHARMA COSMETICS ENVIRONMENTAL MOLECULAR
5x500 ml		01-736BA05	FOOD & BEVERAGES WATER CLINICAL PHARMA COSMETICS ENVIRONMENTAL MOLECULAR
20 plates of 90 mm Ø		064-PA6064	FOOD & BEVERAGES WATER CLINICAL PHARMA COSMETICS ENVIRONMENTAL MOLECULAR
<i>Burkholderia cepacia</i> Selective Supplement (BCSA). 10 vials		06-737LY01	FOOD & BEVERAGES WATER CLINICAL PHARMA COSMETICS ENVIRONMENTAL MOLECULAR



BURKHOLDERIA CEPACIA SELECTIVE AGAR BASE (OFPBL BASE)

► OFPBL

01-739

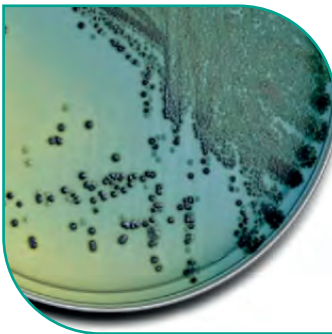
Solid medium for the selective isolation of *Burkholderia cepacia* from clinical specimens and non-clinical samples. Needs Selective Supplement for *Burkholderia cepacia* (OFPBL) Art. No.: 06-741LY01.





PRESENTATION	TYPE OF PACKAGING	ART. NO.	SECTOR
500 g*		01-739-500	FOOD & BEVERAGES WATER CLINICAL PHARMA COSMETICS ENVIRONMENTAL MOLECULAR
Selective Supplement for <i>Burkholderia cepacia</i> (OFPBL). 10 vials		06-741LY01	FOOD & BEVERAGES WATER CLINICAL PHARMA COSMETICS ENVIRONMENTAL MOLECULAR

CARY-BLAIR TRANSPORT MEDIUM

03-643
CMPH

Semisolid non-nutritive medium used for transporting and preserving microbiological specimens.



PRESENTATION	TYPE OF PACKAGING	ART. NO.	SECTOR
500 g*		03-643-500	FOOD & BEVERAGES WATER CLINICAL PHARMA COSMETICS ENVIRONMENTAL MOLECULAR
5x500 ml		03-643BA05	FOOD & BEVERAGES WATER CLINICAL PHARMA COSMETICS ENVIRONMENTAL MOLECULAR



*For dehydrated media presented in a 500 g package, we are able to offer other formats, including 5 and 25 kg. More information at: helpdesk@scharlab.com.

CASEIN LECITHIN POLYSORBATE, BROTH BASE

02-539
FDA / USP

Liquid medium used to dilute and neutralize samples of pharmaceutical, cosmetic, raw material or end products for the purpose of microbial enumeration. This medium needs to add 40 ml of Polysorbate 20 (Art. No. TW00220100) per litre.

PRESENTATION	TYPE OF PACKAGING	ART. NO.	SECTOR						
			FOOD & BEVERAGES	WATER	CLINICAL	PHARMA	COSMETICS	ENVIRONMENTAL	MOLECULAR
500 g*	☐	02-539-500	●	●					
5x500 ml	☐	02-539BA05	●	●					
Polysorbate 20 (Additive), 100 ml	☐	TW00220100	●	●					

CCA, see COLIFORM AGAR BASE CHROMOGENIC MICROINSTANT[®], page 128

CCA (ISO), see COLIFORM AGAR BASE (ISO) CHROMOGENIC MICROINSTANT[®], page 128

CCDA, see CCD MODIFIED AGAR below

CCD MODIFIED AGAR (CHARCOAL CEFOPERAZONE DEOXYCHOLATE)

➤ MCCDA

➤ CCD MODIFIED AGAR

➤ CAMPYLOBACTER BLOOD-FREE SELECTIVE AGAR

01-685
BAM / ISO

Selective plating medium used for the detection and enumeration of *Campylobacter spp.* according to ISO 10272-1 standard. Needs Campylobacter CCDA Selective Supplement (Art. No. 06-133LYO1).

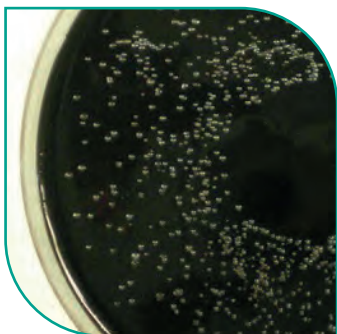

PRESENTATION	TYPE OF PACKAGING	ART. NO.	SECTOR						
			FOOD & BEVERAGES	WATER	CLINICAL	PHARMA	COSMETICS	ENVIRONMENTAL	MOLECULAR
500 g*	☐	01-685-500	●	●					
20 plates of 90 mm Ø	☐	064-PA0009	●	●					
Campylobacter CCDA Selective Supplement, 10 vials	☐	06-133LYO1	●	●					

CETRIMIDE AGAR (EUR. PHARM.)

➤ PSEUDOSSEL

➤ PSEUDOMONAS SELECTIVE MEDIUM

➤ PSEUDOMONAS SELECTIVE AGAR BASE
MEDIUM N EUR. PHARM. 5TH ED.

01-160
AOAC / EP / ISO / HP / USP

Solid culture medium for selective isolation of *Pseudomonas aeruginosa* according to Harmonised Pharmacopoeia Method and 22717 standard. This medium needs glycerol (Art. No. GL00261000).

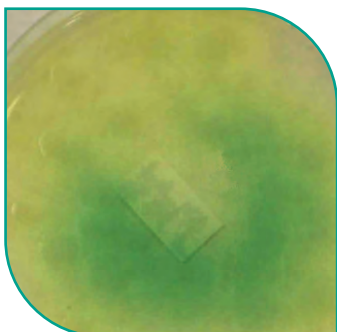

PRESENTATION	TYPE OF PACKAGING	SPECIFICATIONS	ART. NO.	SECTOR						
				FOOD & BEVERAGES	WATER	CLINICAL	PHARMA	COSMETICS	ENVIRONMENTAL	MOLECULAR
500 g*	☐		01-160-500	●	●		●			
5x500 ml	☐		01-160BA05	●	●		●			
20 plates of 90 mm Ø	☐		064-PA0050	●	●		●			
30 contact plates	☐		064-PR0009	●	●		●			
10 flasks with 100 ml	☐	Metallic-non injectable cap	064-BA1032	●	●		●			
10 flasks with 200 ml	☐	Aluminium screw outer cap + Elastomer inner septum	064-BA3037	●	●		●			
Glycerol (Additive), 1 litre	☐		GL00261000	●	●		●			

CETRIMIDE-NALIDIXIC ACID MEDIUM, see CN SELECTIVE AGAR, page 55

CFC AGAR, see PSEUDOMONAS CFC AGAR, page 96

CGA, see CHLORAMPHENICOL GLUCOSE AGAR at the bottom of this page

CHAPMAN AGAR (MANNITOL SALT AGAR)

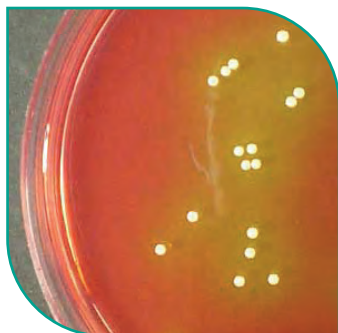

➤ CHAPMAN AGAR

01-116
BAM / EP / HP / ISO / USP

Selective medium for the isolation of pathogenic staphylococci according to the Pharmacopoeial Harmonized Methodology and the ISO 22718 standard.

PRESENTATION	TYPE OF PACKAGING	ART. NO.	FOOD & BEVERAGES	WATER	CLINICAL	PHARMA	COSMETICS	ENVIRONMENTAL	MOLECULAR
500 g*	☐	01-116-500	●	●	●	●			
5x500 ml	☐	01-116BA05	●	●	●	●			
20 plates of 90 mm Ø	☉	064-PA0011	●	●	●	●			
30 plates of 55 mm Ø	☐	064-PF0025	●	●	●	●			
30 contact plates	☐	064-PR0015	●	●	●	●	●		

CHAPMAN TTC AGAR

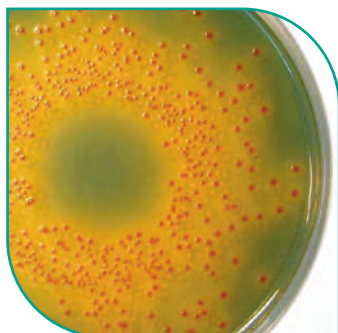

➤ TERGITOL® 7 AGAR

➤ T7 AGAR

➤ LACTOSE TTC HEPTADECYL SODIC SULFATE AGAR

01-053

Medium for the detection of coliforms by membrane filtration in water analyses. Needs a filtered sterile 1% aqueous 2, 3, 5-triphenyltetrazolium chloride (TTC) (Art. No. 06-023).

PRESENTATION	TYPE OF PACKAGING	ART. NO.	FOOD & BEVERAGES	WATER	CLINICAL	PHARMA	COSMETICS	ENVIRONMENTAL	MOLECULAR
500 g*	☐	01-053-500	●	●					
5x500 ml	☐	01-053BA05	●	●					
20 plates of 90 mm Ø	☉	064-PA0048	●	●					
30 plates of 55 mm Ø	☐	064-PF0003	●	●					
TTC 1% sterile solution 100 ml	☐	06-023-100	●	●					

CHLORAMPHENICOL GLUCOSE AGAR (CGA)

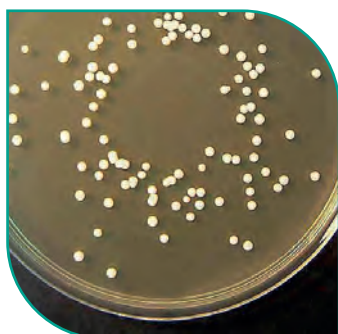

➤ YEAST EXTRACT-GLUCOSE-CHLORAMPHENICOL AGAR
➤ YGC AGAR
➤ YEAST EXTRACT-DEXTROSE-CHLORAMPHENICOL AGAR

➤ YDC AGAR
➤ CGA

01-366
DIN / IDF / ISO

Solid and selective medium for the isolation and enumeration of fungi in milk and dairy products according to ISO 7954 and FIL-IDF 94B standards.

PRESENTATION	TIPO DE ENVASE	SPECIFICATIONS	ART. NO.	FOOD & BEVERAGES	WATER	CLINICAL	PHARMA	COSMETICS	ENVIRONMENTAL	MOLECULAR
500 g*	☐		01-366-500	●						
5x500 ml	☐		01-366BA05	●						
10 flasks with 100 ml	☐	Metalic-non injectable cap	064-BA9992	●						
10 flasks with 200 ml	☐	Metalic-non injectable cap	064-BA8093	●						

 *For dehydrated media presented in a 500 g package, we are able to offer other formats, including 5 and 25 kg. More information at: helpdesk@scharlab.com.

CHOCOLATE AGAR - SUPPLEMENTED



064-PA0001

Medium for the isolation and cultivation of fastidious microorganisms especially *N. meningitidis*, *N. gonorrhoeae* and *Haemophilus spp.*

PRESENTATION	TYPE OF PACKAGING	ART. NO.	SECTOR
20 plates of 90 mm Ø	☉	064-PA0001	●

FOOD & BEVERAGES
WATER
CLINICAL
PHARMA
COSMETICS
ENVIRONMENTAL
MOLECULAR

CHRISTENSEN'S CITRATE AGAR



01-664 BAM / ISO

Differential solid medium to verify the use of citrate as a sole carbon source in the presence of organic nitrogen, according to the ISO 21567 standard.

PRESENTATION	TYPE OF PACKAGING	ART. NO.	SECTOR
500 g*	☐	01-664-500	●
5x500 ml	☐	01-664BA05	●

FOOD & BEVERAGES
WATER
CLINICAL
PHARMA
COSMETICS
ENVIRONMENTAL
MOLECULAR

CIN AGAR, see YERSINIA CIN AGAR BASE, page 126

CLED AGAR



- CYSTINE LACTOSE ELECTROLYTE DEFICIENT AGAR
- BROLACIN AGAR

01-047

Cystine, lactose, electrolyte deficient medium, recommended for the isolation and identification of urinary pathogenic bacteria.

PRESENTATION	TYPE OF PACKAGING	ART. NO.	SECTOR
500 g*	☐	01-047-500	●
5x500 ml	☐	01-047BA05	●
20 plates of 90 mmØ	☉	064-PA0010	●

FOOD & BEVERAGES
WATER
CLINICAL
PHARMA
COSMETICS
ENVIRONMENTAL
MOLECULAR

CLOSTRIDIUM PERFRINGENS SELECTIVE AGAR (SPS AGAR)

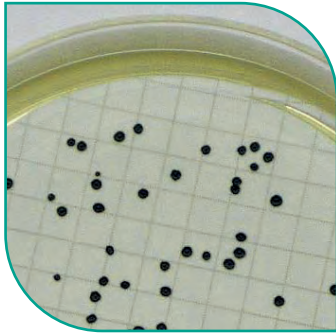

➤ SULFITE POLYMYXIN SULFADIAZINE AGAR

➤ SPS AGAR

➤ PERFRINGENS SELECTIVE AGAR

01-050
APHA / BAM / FDA

Solid medium for the detection of *Clostridium perfringens* in food.

PRESENTATION	TYPE OF PACKAGING	SPECIFICATIONS	ART. NO.	FOOD & BEVERAGES	WATER	CLINICAL	PHARMA	COSMETICS	ENVIRONMENTAL	MOLECULAR
500 g*			01-050-500	●	●			●		
5x500 ml			01-050BA05	●	●			●		
20 plates of 90 mm Ø			064-PA0073	●	●			●		
30 plates of 55 mm Ø			064-PF0002	●	●			●		
10 flasks with 100 ml		Metalic-non injectable cap	064-BA0027	●	●			●		
20 tubes with 10 ml		Ink labelled tubes and metallic-non injectable cap	064-TA0110	●	●			●		
20 tubes with 10 ml		Double concentration Ink labelled tubes and metallic cap	064-TA2161	●	●			●		
20 tubes with 10 ml		Ink labelled tubes and metallic-non injectable cap with paraffine	064-TA2115	●	●			●		

CNA, see COLUMBIA CNA AGAR BASE, page 56

CN SELECTIVE AGAR

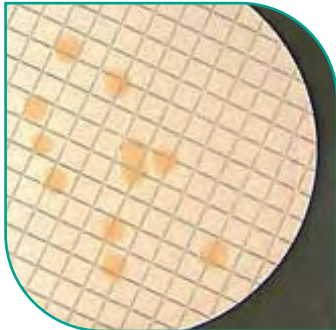



➤ CN PSEUDOMONAS AGAR

➤ CN MEDIUM

➤ CETRIMIDE-NALIDIXIC ACID MEDIUM

01-609
EN / ISO

Selective solid medium used for the detection of *Pseudomonas aeruginosa* according to the EN 12780-2002 and ISO 16266 standard. This medium needs add Nalidixic Acid Selective Supplement (Art. No. 06-124LY01).



PRESENTATION	TYPE OF PACKAGING	ART. NO.	FOOD & BEVERAGES	WATER	CLINICAL	PHARMA	COSMETICS	ENVIRONMENTAL	MOLECULAR
500 g*		01-609-500	●	●	●			●	
5x500 ml		01-609BA05	●	●	●			●	
30 plates of 55 mm Ø		064-PF0005	●	●		●			
Nalidixic acid Selective Supplement. 10 vials		06-124LY01	●	●	●			●	

COLUMBIA AGAR (EUR. PHARM)



01-680
EP / USP

Highly nutritious general purpose medium used for the isolation and cultivation of fastidious and nonfastidious microorganisms from clinical and non-clinical materials according to the Pharmacopeial European Harmonized Method 9.0 and USP 33-NF 28.

PRESENTATION	TYPE OF PACKAGING	ART. NO.	FOOD & BEVERAGES	WATER	CLINICAL	PHARMA	COSMETICS	ENVIRONMENTAL	MOLECULAR
500 g*		01-680-500				●			
5x500 ml		01-680BA05				●			



*For dehydrated media presented in a 500 g package, we are able to offer other formats, including 5 and 25 kg. More information at: helpdesk@scharlab.com.

COLUMBIA CNA AGAR BASE



01-703

Solid medium used, with the addition of blood for the selective isolation of Gram positive cocci, from clinical samples. For dehydrated version of the medium (Art. No. 01-703-500) adding blood.

PRESENTATION	TYPE OF PACKAGING	ART. NO.	SECTOR						
			FOOD & BEVERAGES	WATER	CLINICAL	PHARMA	COSMETICS	ENVIRONMENTAL	MOLECULAR
500 g*	☐	01-703-500			●				
20 plates of 90 mm Ø	☉	064-PA0053			●				

m-CP AGAR BASE

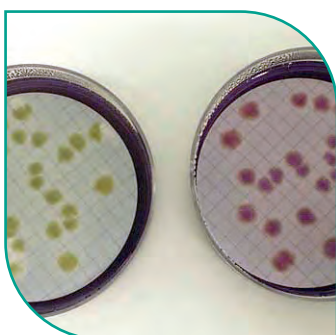

01-513

EP

Solid medium for the enumeration and isolation of *Clostridium perfringens* in water according to the European Directive 12767/97. This medium needs to add m-CP Selective Supplement (Art. No. 06-125LY01). This medium requires the use of ammonium hydroxide for confirmation.

PRESENTATION	TYPE OF PACKAGING	ART. NO.	SECTOR						
			FOOD & BEVERAGES	WATER	CLINICAL	PHARMA	COSMETICS	ENVIRONMENTAL	MOLECULAR
500 g*	☐	01-513-500		●					
5x500 ml	☐	01-513BA05		●					
12 plates of 55 mm Ø	☉☉	064PF0030C		●					
30 plates of 55 mm Ø	☉☉☉	064-PF0030		●					
m-CP Selective Supplement. 10 vials	☐	06-125LY01		●					

CRONOBACTER SELECTIVE BROTH BASE (CSB)

02-827

ISO

Liquid culture medium for the selective enrichment of *Cronobacter spp.* from the pre-enrichment of food samples, in accordance with ISO 22964. This broth need the addition of Vancomycine Selective Supplement 5 mg (Art. No. 06-712LY01).

DESCRIPTION	TYPE OF PACKAGING	ART. NO.	SECTOR						
			FOOD & BEVERAGES	WATER	CLINICAL	PHARMA	COSMETICS	ENVIRONMENTAL	MOLECULAR
500 g*	☐	02-827-500	●	●				●	
Vancomycine Selective Supplement 5 mg. 10 vials	☐	06-712LY01	●	●				●	

CZAPEK-DOX AGAR



01-051

APHA-AWWA

Solid semisynthetic medium for the cultivation of fungi, with nitrate as a sole nitrogen source. For greater efficiency add Yeast Extract (Art. No. 07-079).

PRESENTATION	TYPE OF PACKAGING	ART. NO.	SECTOR						
			FOOD & BEVERAGES	WATER	CLINICAL	PHARMA	COSMETICS	ENVIRONMENTAL	MOLECULAR
500 g*	☐	01-051-500	●					●	
20 plates of 90 mm Ø	☉	064-PA0066			●			●	

D/E NEUTRALIZING AGAR BASE

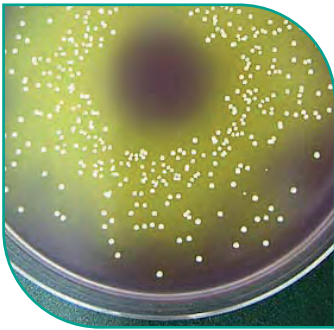

► DEY-ENGLEY NEUTRALIZING AGAR

01-802
COMPF / ISO / SMD

Solid culture medium for the neutralization and testing of antiseptics and disinfectants. This medium needs addition Polysorbate 80 (Art. No. TW0080).

PRESENTATION	TYPE OF PACKAGING	ART. NO.	SECTOR
500 g*	☐	01-802-500	FOOD & BEVERAGES
Polysorbate 80 (Additive). 100 ml	☐	TW00800100	WATER, CLINICAL, PHARMA, COSMETICS, ENVIRONMENTAL, MOLECULAR

D/E NEUTRALIZING BROTH BASE

02-802
ISO / SMD

Liquid medium for enrichment cultures in cosmetics, according to ISO 21149, 21150, 22717 and 22718 standards. Needs Polysorbate 80 (Art. No. TW00800100) for dehydrated medium (Art. No. 02-802-500).

PRESENTATION	TYPE OF PACKAGING	SPECIFICATIONS	ART. NO.	SECTOR
500 g*	☐		02-802-500	FOOD & BEVERAGES, COSMETICS, ENVIRONMENTAL, MOLECULAR
10 flasks with 40 ml	☐	Metalic-non injectable cap	064-V00100	ENVIRONMENTAL, MOLECULAR
10 bottles with 100 ml	☐	Includes 5 mg/ml Polysorbate 80. Injectable cap: plastic cap with thread	064-BA7029	PHARMA, COSMETICS, ENVIRONMENTAL, MOLECULAR
Polysorbate 80 (Additive). 100 ml	☐		TW00800100	COSMETICS, ENVIRONMENTAL, MOLECULAR

DECARBOXYLASE LYSINE BROTH (TAYLOR)



02-336
COMPF / IDF / ISO

Liquid medium to differentiate enteric bacteria using L-Lysine decarboxylation assays according to ISO 6785 and 21567 and FIL-IDF standards.

PRESENTATION	TYPE OF PACKAGING	SPECIFICATIONS	ART. NO.	SECTOR
500 g*	☐		02-336-500	FOOD & BEVERAGES
20 tubes with 7 ml	☐		064TA0125L	FOOD & BEVERAGES

DEOXYCHOLATE CITRATE MODIFIED AGAR ACCORDING TO HYNES

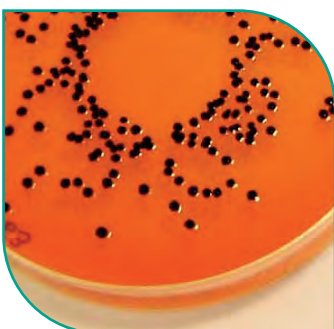

01-566

Solid medium for the isolation of *Salmonella* and *Shigella* according to Leifson, modified by Hynes.

PRESENTATION	TYPE OF PACKAGING	ART. NO.	SECTOR
500 g*	☐	01-566-500	FOOD & BEVERAGES



*For dehydrated media presented in a 500 g package, we are able to offer other formats, including 5 and 25 kg. More information at: helpdesk@scharlab.com.

DEOXYCHOLATE LACTOSE AGAR

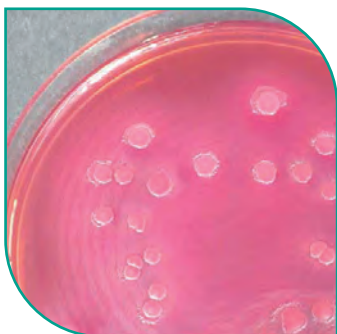



► DCL AGAR

01-057

APHA / COMPF / ISO / SMWW

Differential solid medium for the isolation of enterobacteria according to APHA, AOAC and others standards.

PRESENTATION	TYPE OF PACKAGING	ART. NO.	FOOD & BEVERAGES	WATER	CLINICAL	PHARMA	COSMETICS	ENVIRONMENTAL	MOLECULAR
500 g*		01-057-500	●	●	●				
5x500 ml		01-057BA05	●	●	●				

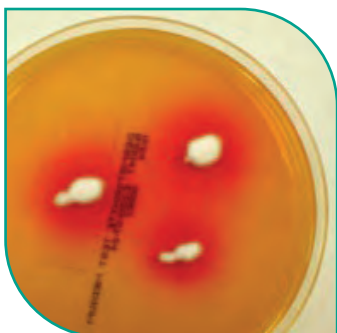

DERMATOPHYTES SELECTIVE AGAR



- DTM AGAR
- TAPLIN AGAR
- DERMATOPHYTES MEDIUM TEST

01-442

Selective and differential solid medium used for the isolation and presumptive identification of dermatophytes.

PRESENTATION	TYPE OF PACKAGING	ART. NO.	FOOD & BEVERAGES	WATER	CLINICAL	PHARMA	COSMETICS	ENVIRONMENTAL	MOLECULAR
500 g*		01-442-500			●				
20 plates of 90 mm Ø		064-PA0012			●				
30 contact plates		064-PR0092			●				

DEXTROSE TRYPTONE PURPLE BROMCRESOL AGAR

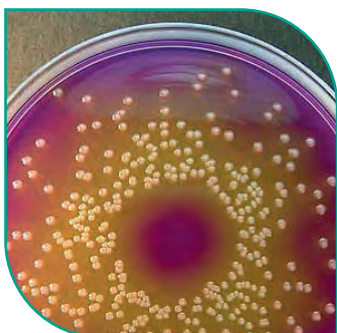

► BCP AGAR

01-556

APHA

Solid medium for the cultivation of "flat-sour" canned food spoiling microorganisms.

PRESENTATION	TYPE OF PACKAGING	ART. NO.	FOOD & BEVERAGES	WATER	CLINICAL	PHARMA	COSMETICS	ENVIRONMENTAL	MOLECULAR
500 g*		01-556-500	●						

DG 18 AGAR

➤ DICHLORAN-GLYCEROL 18 AGAR

01-485
ISO

Solid differential and low water activity medium used for the determination of xerophilic fungi in low moisture food and in indoor air according to the ISO 16000-17 and 21527-2 standards.

PRESENTATION	TYPE OF PACKAGING	ART. NO.	FOOD & BEVERAGES	WATER	CLINICAL	PHARMA	COSMETICS	ENVIRONMENTAL	MOLECULAR
500 g*	☐	01-485-500	●					●	
20 plates of 90 mm Ø	☉	064-PA0064	●					●	

DICHLORAN-GLYCEROL 18 AGAR

PRESENTATION	TYPE OF PACKAGING	SPECIFICATIONS	ART. NO.	FOOD & BEVERAGES	WATER	CLINICAL	PHARMA	COSMETICS	ENVIRONMENTAL	MOLECULAR
10 flasks with 125 ml	☒	Metallic-non injectable cap	064-BA1546	●					●	

DG 18 METAL AGAR

064-PA6066
ISO

Solid differential and low water activity medium used for the determination of xerophilic fungi in low moisture food and in indoor air supplemented with trace metals according to ISO 16000-17 and 21527-2 standards.

PRESENTATION	TYPE OF PACKAGING	ART. NO.	FOOD & BEVERAGES	WATER	CLINICAL	PHARMA	COSMETICS	ENVIRONMENTAL	MOLECULAR
20 plates of 90 mm Ø	☉	064-PA6066	●		●				

DICHLORAN ROSE BENGAL CHLORAMPHENICOL AGAR



➤ DRBC AGAR

01-657
ISO

Selective medium for the enumeration of moulds and yeasts in foods according to ISO 21527-1 standard.

PRESENTATION	TYPE OF PACKAGING	SPECIFICATIONS	ART. NO.	FOOD & BEVERAGES	WATER	CLINICAL	PHARMA	COSMETICS	ENVIRONMENTAL	MOLECULAR
500 g*	☐		01-657-500	●						
5x500 ml	☐		01-657BA05	●						
20 plates of 90 mm Ø	☉		064-PA6068	●						
10 flasks with 100 ml	☒	Metallic-non injectable cap	064-BA8063	●						

DNASE AGAR

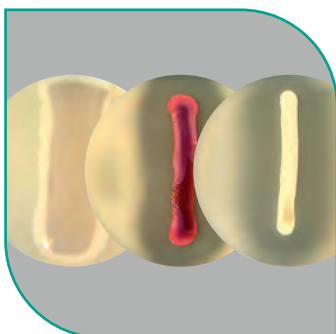

➤ DNASE TEST AGAR
➤ DEOXYRIBONUCLEASE TEST AGAR

➤ DEOXYRIBONUCLEIC ACID AGAR
➤ DNA AGAR

01-346

Solid culture medium for the determination of the deoxyribonuclease activity of microorganisms, especially staphylococci and *Serratia* spp.

PRESENTATION	TYPE OF PACKAGING	SPECIFICATIONS	ART. NO.	FOOD & BEVERAGES	WATER	CLINICAL	PHARMA	COSMETICS	ENVIRONMENTAL	MOLECULAR
500 g*	☐		01-346-500	●		●				
5x500 ml	☐		01-346BA05	●		●				
20 plates of 90 mm Ø, with methyl green	☉	1 box with 2 RD-PACK with 10 plates 90 mm Ø /pack. Film wrapping	064-PA6138	●		●				

DRCM, see REINFORCED CLOSTRIDIAL MEDIUM DIFFERENTIAL, page 99

DRIGALSKY LACTOSE AGAR



01-660

Solid selective medium for the isolation of Gram negative bacteria from clinical specimens.

PRESENTATION	TYPE OF PACKAGING	ART. NO.	FOOD & BEVERAGES	WATER	CLINICAL	PHARMA	COSMETICS	ENVIRONMENTAL	MOLECULAR
500 g*	☐	01-660-500			●				

DTM, see DERMATOPHYTES SELECTIVE AGAR, page 58

E. COLI BROTH (EC BROTH)

► EC BROTH



02-060

APHA / COMPF / ISO / SMWW / WEF

Selective medium for the detection and enumeration (MPN) of enterobacteria, in water and foodstuffs according to ISO 7251 and 9308-2 standards.

PRESENTATION	TYPE OF PACKAGING	ART. NO.	FOOD & BEVERAGES	WATER	CLINICAL	PHARMA	COSMETICS	ENVIRONMENTAL	MOLECULAR
500 g*	☐	02-060-500	●	●	●				
5x500 ml	☐	02-060BA05	●	●	●				
20 tubes of 9 ml	↑	064TA2155E	●	●	●				

EE BROTH, see ENRICHMENT ENTEROBACTERIACEAE BROTH, page 61

EMB AGAR, see ENRICHMENT ENTEROBACTERIACEAE BROTH, page 61

ENDO AGAR BASE

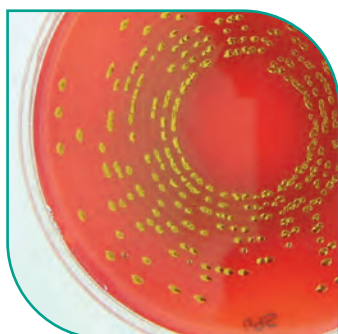

01-589

AOAC / COMPF / SMD

Moderately selective solid medium used for the detection of coliforms and other enteric organisms, in milk and water, according to APHA specifications.

PRESENTATION	TYPE OF PACKAGING	ART. NO.	FOOD & BEVERAGES	WATER	CLINICAL	PHARMA	COSMETICS	ENVIRONMENTAL	MOLECULAR
500 g*	☐	01-589-500	●	●					
5x500 ml	☐	01-589BA05	●	●					
Basic Fuchsin Supplement	☐	FU00600100	●	●					

ENDO LES AGAR

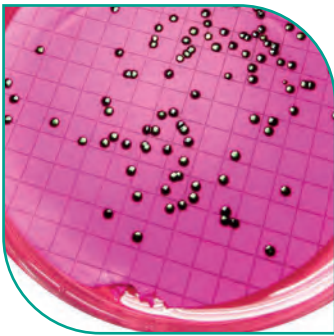

064-PF9999
APHA

Medium for detecting and enumerating coliforms in water and foods, by the filter membrane method.

PRESENTATION	TYPE OF PACKAGING	ART. NO.	FOOD & BEVERAGES	WATER	CLINICAL	PHARMA	COSMETICS	ENVIRONMENTAL	MOLECULAR
30 plates of 55 mm Ø	☐	064-PF9999		●					

ENRICHMENT ENTEROBACTERIACEAE BROTH (EE BROTH)

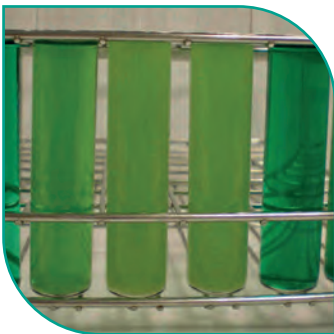

- EE MOSSEL
- EE BROTH
- MEDIUM E EUR. PHARM. 5TH ED.

02-064
EP / HP / ISO / USP

Liquid culture medium used for the enrichment of enterobacteria according to the ISO 21528-1 standard and the Pharmacopeial Harmonised Method.

PRESENTATION	TYPE OF PACKAGING	SPECIFICATIONS	ART. NO.	FOOD & BEVERAGES	WATER	CLINICAL	PHARMA	COSMETICS	ENVIRONMENTAL	MOLECULAR
500 g*	☐		02-064-500	●			●			
5x500 ml	☐		02-064BA05	●			●			
10 flasks with 90 ml	☐	Non injectable cap	064-BA6073	●			●			
10 flasks with 100 ml	☐		064-BA2144	●			●			
20 tubes with 9 ml	☐	Ink labelled tubes and metallic cap	064-TA0189	●			●			
20 tubes with 10 ml double concentration	☐	Ink labelled tubes and metallic cap	064-TA0193	●			●			

EOSIN METHYLENE BLUE AGAR (EMB AGAR)

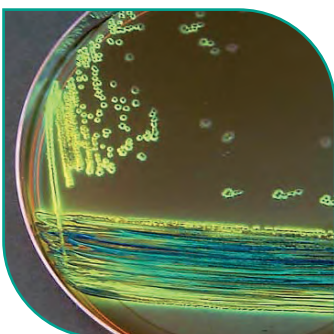

- EMB AGAR
- LEVINE AGAR

01-068
BAM / ISO / USP

Selective differential medium for the isolation and enumeration of coliforms according to ISO 21150 and USP standard.

PRESENTATION	TYPE OF PACKAGING	ART. NO.	FOOD & BEVERAGES	WATER	CLINICAL	PHARMA	COSMETICS	ENVIRONMENTAL	MOLECULAR
500 g*	☐	01-068-500	●	●	●	●	●		
5x500 ml	☐	01-068BA05	●	●	●	●	●		
20 plates of 90 mm Ø	☐	064-PA0013	●	●	●	●	●		

ESIA BROTH, see SAKAZAKII AGAR CHROMOGENIC MICROINSTANT® , page 130



*For dehydrated media presented in a 500 g package, we are able to offer other formats, including 5 and 25 kg. More information at: helpdesk@scharlab.com.

EUGON LT MODIFIED AGAR



01-862

Solid medium used for the enumeration of aerobic bacteria including *E. coli*, in cosmetic products with and without preservatives.

► **NOTE:** Pending the new ISO standard to adjust the composition.

PRESENTATION	TYPE OF PACKAGING	ART. NO.	SECTOR							
			FOOD & BEVERAGES	WATER	CLINICAL	PHARMA	COSMETICS	ENVIRONMENTAL	MOLECULAR	
500 g*	☐	01-862-500							●	
20 plates of 90 mm Ø	☐	064-PA6149							●	

EUGON LT MODIFIED BROTH



02-862

Liquid medium used for the enumeration of aerobic bacteria including *E. coli*, in cosmetic products with and without preservatives.

► **NOTE:** Pending the new ISO standard to adjust the composition.

PRESENTATION	TYPE OF PACKAGING	SPECIFICATIONS	ART. NO.	SECTOR						
				FOOD & BEVERAGES	WATER	CLINICAL	PHARMA	COSMETICS	ENVIRONMENTAL	MOLECULAR
500 g*	☐		02-862-500		●				●	
10 flasks with 90 ml	☐	Injectable cap: Plastic screw inner cap	064-BA8233		●				●	
10 flasks with 100 ml	☐	Injectable cap: Plastic screw inner cap	064-BA8234		●				●	
20 tubes with 9 ml	☐	Ink labelled tubes and metallic cap	064-TA8366		●				●	

EVA BROTH, see AZIDE ETHYL VIOLET BROTH, page 40

FECAL COLIFORMS AGAR (m-FC AGAR)

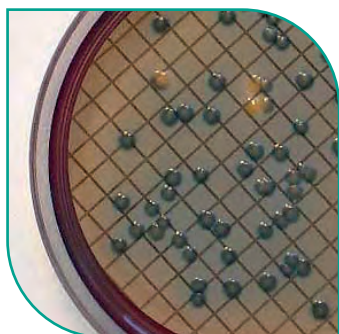

► M-FC AGAR

01-287 APHA

Selective and differential solid medium for the enumeration of coliforms by membrane filtration technique according to APHA method. This medium needs add 10 ml of Rosolic Acid Solution 1% (Art. No. 064-BA8005).

PRESENTATION	TYPE OF PACKAGING	ART. NO.	SECTOR							
			FOOD & BEVERAGES	WATER	CLINICAL	PHARMA	COSMETICS	ENVIRONMENTAL	MOLECULAR	
500 g*	☐	01-287-500		●						
30 plates of 55 mm Ø	☐	064-PF0024		●						
Rosolic Acid Solution 1% (additive). 100 ml	☐	064-BA8005		●						

FLUID A



► BACTERIOLOGICAL PEPTONE 0.1%

EP / USP

For use as rinsing and/or diluting fluid for membrane filtration methods according to USP and harmonized European Pharmacopoeia 9.0.

PRESENTATION	TYPE OF PACKAGING	SPECIFICATIONS	ART. NO.	SECTOR						
				FOOD & BEVERAGES	WATER	CLINICAL	PHARMA	COSMETICS	ENVIRONMENTAL	MOLECULAR
10 flasks with 100 ml	☐	Injectable cap: Plastic screw inner cap + elastomer septum + protective outer cap + shrink wrapped plastic sleeve	064-BA8012				●			
10 flasks with 100 ml	☐	Injectable cap: Plastic screw inner cap + elastomer septum + protective outer cap	064-BA6002				●			
10 flasks with 200 ml	☐	Injectable cap: Plastic screw inner cap + elastomer septum + protective outer cap + shrink wrapped plastic sleeve	064-BA8013				●			
10 flasks with 300 ml	☐	Injectable cap: Plastic screw inner cap + elastomer septum + protective outer cap	064-BA8047				●			
10 flasks with 450 ml	☐	Injectable cap: Plastic screw inner cap + elastomer septum + protective outer cap	064-BA3071				●			
6 flasks with 600 ml	☐	Injectable cap: Plastic screw inner cap	064-BA8133				●			
6 flasks with 850 ml	☐	Injectable cap: Plastic screw inner cap + elastomer septum + protective outer cap	064-BA8103				●			

FLUID A 0.1% + BUFFER



064-BA7037

EP / USP

Diluent (buffer peptone water 0.1% without NaCl) for the homogenization of samples for the microbiological examination according to the European Pharmacopoeia Harmonised Method 9.0 and USP 33- NF 28.

PRESENTATION	TYPE OF PACKAGING	SPECIFICATIONS	ART. NO.	SECTOR						
				FOOD & BEVERAGES	WATER	CLINICAL	PHARMA	COSMETICS	ENVIRONMENTAL	MOLECULAR
10 flasks with 100 ml	☐	Injectable cap: Plastic screw inner cap + elastomer septum + protective outer cap + shrink wrapped plastic sleeve	064-BA7037				●			
10 flasks with 300 ml	☐	Injectable cap: Plastic screw inner cap + elastomer septum + protective outer cap + shrink wrapped plastic sleeve	064-BA7052				●			

FLUID D



► PEPTONE POLYSORBATE

064-BA0001

EP / USP

For use as rinsing and/or diluting fluid for membrane filtration methods according to USP and harmonized European Pharmacopoeia 9.0.

PRESENTATION	TYPE OF PACKAGING	SPECIFICATIONS	ART. NO.	SECTOR						
				FOOD & BEVERAGES	WATER	CLINICAL	PHARMA	COSMETICS	ENVIRONMENTAL	MOLECULAR
10 flasks with 100 ml	☐	Injectable cap: Plastic screw inner cap + elastomer septum + protective outer cap + shrink wrapped plastic sleeve	064-BA0001				●			
10 flasks with 300 ml	☐	Injectable cap: Plastic screw inner cap + elastomer septum + protective outer cap	064-BA6006				●			



*For dehydrated media presented in a 500 g package, we are able to offer other formats, including 5 and 25 kg. More information at: helpdesk@scharlab.com.

FLUID K



064-BA8085 EP / USP

Diluent for the homogenization of samples for the microbiological examination according to the European Pharmacopoeial Harmonised Method.

PRESENTATION	TYPE OF PACKAGING	SPECIFICATIONS	ART. NO.	SECTOR
10 flasks with 450 ml		Plastic screw inner cap + elastomer septum + protective outer cap	064-BA8085	●
10 flasks with 300 ml		Plastic screw inner cap + elastomer septum + protective outer cap	064-BA8048	●

FOOD & BEVERAGES
WATER
CLINICAL
PHARMA
COSMETICS
ENVIRONMENTAL
MOLECULAR

FRASER LISTERIA ENRICHMENT BROTH, see LISTERIA ENRICHMENT BROTH FRASER, page 76

FTM, see THIOGLYCOLLATE FLUID MEDIUM, page 110

GBS MODIFIED AGAR

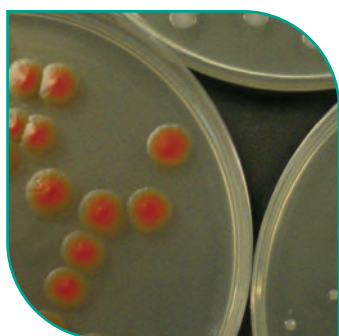

064-PA2117

Selective solid medium for the isolation and primary identification of *Streptococcus agalactiae* from clinical specimens.

PRESENTATION	TYPE OF PACKAGING	ART. NO.	SECTOR
20 plates of 90 mm Ø		064-PA2117	●

FOOD & BEVERAGES
WATER
CLINICAL
PHARMA
COSMETICS
ENVIRONMENTAL
MOLECULAR

GC AGAR BASE







01-310

Particularly suitable base medium for the isolation and cultivation of fastidious microorganisms.

This base serves to prepare different medium:

- **Chocolate Agar:** Medium for growth of pathogens such as *Haemophilus influenzae*. This medium has to be boiled for the typical dark chocolate. You need addition of blood.
- **Thayer Martin Agar (TMA):** Medium for the isolation of *Neisseria*. Necessary to add supplements to the base medium:
 - Haemoglobin
 - VCNT Selective Supplement (Art. No. 06-142LYO1): 1 vial per 500 ml average basis.
 - GPS - Growth Promotion Supplements (Art. No. 06-144LYO1): 1 vial 500 ml each medium base. (This added supplement improves cell recovery stressed).
- **Transgrow Agar:** Medium for cultivation and transportation of *Neisseria*. Is the same as the TMA but dispensed in tubes and solidified horizontally.

► **NOTE:** For ready-to-use medium in Petri dish format, see **Thayer Martin VCNT**, page 109.

PRESENTATION	TYPE OF PACKAGING	ART. NO.	SECTOR
500 g*		01-310-500	●
VCNT Selective Supplement. 10 vials.		06-142LYO1	●
GPS - Growth Promotion Supplements. 5 Freeze-dried vials + 5 Rehydration vials		06-144LYO1	●
10 vials. VCAT Selective Supplement		06-141LYO1	●

FOOD & BEVERAGES
WATER
CLINICAL
PHARMA
COSMETICS
ENVIRONMENTAL
MOLECULAR



*For dehydrated media presented in a 500 g package, we are able to offer other formats, including 5 and 25 kg. More information at: helpdesk@scharlab.com.

GIOLITTI-CANTONI BROTH

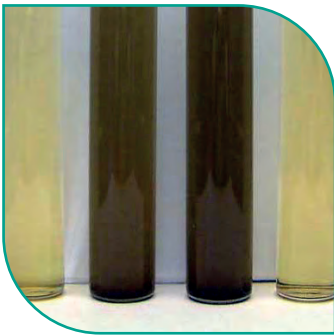

02-230
EN / IDF / ISO

Liquid medium used for the recovery and enumeration of low numbers of coagulase-positive staphylococci in foods according to ISO 5944, FIL-IDF and EN standards. Needs 1% Potassium Tellurite Sterile Solution Additive (Art. No. 06-089).

PRESENTATION	TYPE OF PACKAGING	SPECIFICATIONS	ART. NO.	FOOD & BEVERAGES	WATER	CLINICAL	PHARMA	COSMETICS	ENVIRONMENTAL	MOLECULAR
500 g*	☐		02-230-500	●						
5x500 ml	☐		02-230BA05	●						
20 tubes with 10 ml	∩	Double concentration Ink labelled tubes and metallic-non injectable cap	064-TA0191	●						
20 tubes with 19 ml	∩	Ink labelled tubes and metallic cap	064-TA0190	●						
100 ml Potassium Tellurite 1% Sterile Solution (Additive)	☐		06-089-100	●						

GLUCOSE BROMOCRESOL PURPLE AGAR

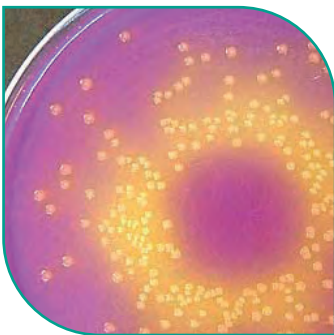

01-502
ISO

Solid medium for the confirmation of enterobacteria in diverse samples according to ISO 8523, 4702, 21528-1 and 21528-2 standards.

PRESENTATION	TYPE OF PACKAGING	SPECIFICATIONS	ART. NO.	FOOD & BEVERAGES	WATER	CLINICAL	PHARMA	COSMETICS	ENVIRONMENTAL	MOLECULAR
500 g*	☐		01-502-500	●						
5x500 ml	☐		01-502BA05	●						
20 tubes with 7 ml	∩	Ink labelled tubes and metallic cap	064-TA8288	●						

GLUCOSE PEPTONE CHLORAMPHENICOL AGAR (GP AGAR WITH ANTIBIOTIC)



01-692
ISO

Solid culture medium used for enumeration of yeast and mould in cosmetics according to the ISO 16212 standard.

PRESENTATION	TYPE OF PACKAGING	ART. NO.	FOOD & BEVERAGES	WATER	CLINICAL	PHARMA	COSMETICS	ENVIRONMENTAL	MOLECULAR
500 g*	☐	01-692-500					●		

GN BROTH, see GRAM NEGATIVE BROTH, page 66



*For dehydrated media presented in a 500 g package, we are able to offer other formats, including 5 and 25 kg. More information at: helpdesk@scharlab.com.

GRAM NEGATIVE BROTH (GN BROTH)

➤ HAJNA BROTH ➤ GN ENRICHMENT BROTH ➤ GN BROTH

02-093
COMPF

Liquid culture medium for enteric bacteria according to the formulation of Hajna.



PRESENTATION	TYPE OF PACKAGING	ART. NO.	FOOD & BEVERAGES	WATER	CLINICAL	PHARMA	COSMETICS	ENVIRONMENTAL	MOLECULAR
500 g*		02-093-500	●						
5x500 ml		02-093BA05	●						



m-GREEN AGAR

➤ M-GREEN YEAST & MOULD AGAR

01-633
ISO

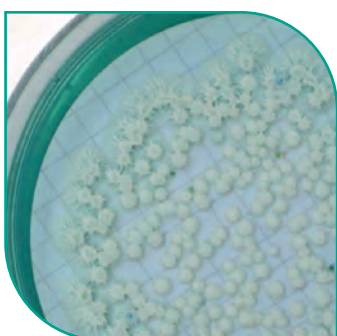
Solid selective culture medium for enumeration of fungi according to ISO 10718 standard.



PRESENTATION	TYPE OF PACKAGING	ART. NO.	FOOD & BEVERAGES	WATER	CLINICAL	PHARMA	COSMETICS	ENVIRONMENTAL	MOLECULAR
500 g*		01-633-500	●	●					
30 plates of 55 mm Ø		064PF0089P	●	●					



m-GREEN BROTH

➤ M-GREEN YEAST & MOULD BROTH

02-633
ISO

Liquid selective culture medium used for the enumeration of fungi according to ISO 10718 standard.



PRESENTATION	TYPE OF PACKAGING	ART. NO.	FOOD & BEVERAGES	WATER	CLINICAL	PHARMA	COSMETICS	ENVIRONMENTAL	MOLECULAR
500 g*		02-633-500		●					
5x500 ml		02-633BA05		●					
50 vials of 2 ml		064-CT0001		●					



GVPC, see LEGIONELLA SELECTIVE (GVPC) AGAR (ISO), page 73

HAEMOPHILUS TEST AGAR BASE (HTM)

➤ HTM AGAR ➤ HAEMOPHILUS TEST MEDIUM AGAR BASE ➤ HAEMOPHILUS TEST MEDIUM

01-706

Solid medium for sensitivity testing of *Haemophilus influenzae* and *H. parainfluenzae* to antibiotics and other antimicrobials by the agar diffusion technique. Needs Haemophilus HTM Supplement (Art. No. 06-155LY01).

PRESENTATION	TYPE OF PACKAGING	ART. NO.	FOOD & BEVERAGES	WATER	CLINICAL	PHARMA	COSMETICS	ENVIRONMENTAL	MOLECULAR
500 g*		01-706-500			●				
Haemophilus HTM Supplement. 10 vials		06-155LY01			●				



*For dehydrated media presented in a 500 g package, we are able to offer other formats, including 5 and 25 kg. More information at: helpdesk@scharlab.com.

HC AGAR BASE



01-298

Selective solid medium for the enumeration of yeast and molds in cosmetic products.

PRESENTATION	TYPE OF PACKAGING	ART. NO.	FOOD & BEVERAGES	WATER	CLINICAL	PHARMA	COSMETICS	ENVIRONMENTAL	MOLECULAR
500 g*	☐	01-298-500					●		

HEKTOEN ENTERIC AGAR

- HE AGAR
- HEA

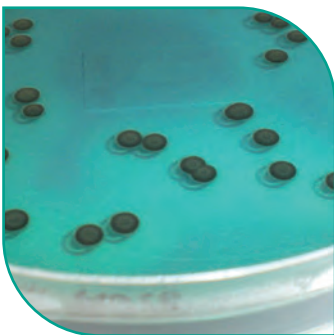

01-216
ISO

Solid, selective and differential culture medium for isolation of pathogenic enterobacteria from contaminated samples according to ISO 21567 standard.

PRESENTATION	TYPE OF PACKAGING	ART. NO.	FOOD & BEVERAGES	WATER	CLINICAL	PHARMA	COSMETICS	ENVIRONMENTAL	MOLECULAR
500 g*	☐	01-216-500	●		●				
5x500 ml	☐	01-216BA05	●		●				
20 plates of 90 mm Ø	☉	064-PA0014	●		●				
30 contact plates	☐☐☐	064-PR0012	●		●				

HTM, see HAEMOPHILUS TEST AGAR BASE on previous page

IRON SULFITE MODIFIED AGAR

01-634
ISO / NMKL

Solid differential medium used for the enumeration of sulfite-reducing bacteria from foods and animal feeding stuffs according to ISO 15213 standard.

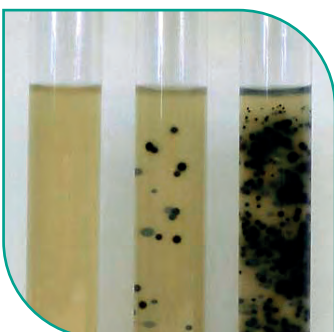

PRESENTATION	TYPE OF PACKAGING	SPECIFICATIONS	ART. NO.	FOOD & BEVERAGES	WATER	CLINICAL	PHARMA	COSMETICS	ENVIRONMENTAL	MOLECULAR
500 g*	☐		01-634-500	●					●	
5x500 ml	☐		01-634BA05	●					●	
10 flasks with 200 ml	☐	Metallic-non injectable cap	064-BA7080	●					●	



*For dehydrated media presented in a 500 g package, we are able to offer other formats, including 5 and 25 kg. More information at: helpdesk@scharlab.com.

K AGAR



01-674
IFU

Selective solid medium used for the isolation of *Alicyclobacillus acidoterrestris*, in fruit juices according to IFU standard method No. 12.

PRESENTATION	TYPE OF PACKAGING	ART. NO.	FOOD & BEVERAGES	WATER	CLINICAL	PHARMA	COSMETICS	ENVIRONMENTAL	MOLECULAR
500 g*	☐	01-674-500	●						
5x500 ml	☐	01-674BA05	●						

KAA AGAR, see KANAMYCIN ESCULIN AZIDE AGAR below

KAA BROTH, see KANAMYCIN ESCULIN AZIDE BROTH below

KANAMYCIN ESCULIN AZIDE AGAR (KAA AGAR)

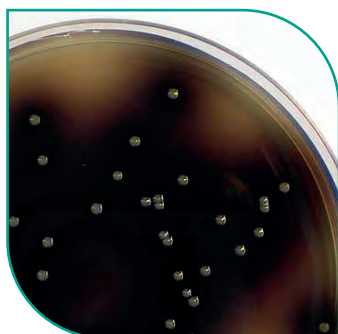

► KAA AGAR

01-263
COMPF

Solid medium for confirmative detection and isolation of Lancefield's group D streptococci in food samples.

PRESENTATION	TYPE OF PACKAGING	ART. NO.	FOOD & BEVERAGES	WATER	CLINICAL	PHARMA	COSMETICS	ENVIRONMENTAL	MOLECULAR
500 g*	☐	01-263-500	●	●		●			

KANAMYCIN ESCULIN AZIDE BROTH (KAA BROTH)

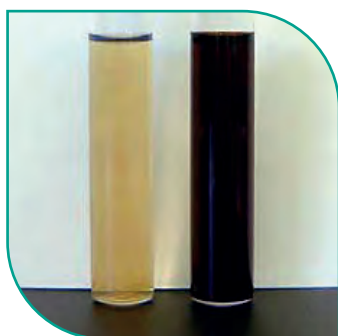

► KAA BROTH

02-263
COMPF

Liquid medium for the presumptive detection of Lancefield's group D streptococci in food samples.

PRESENTATION	TYPE OF PACKAGING	SPECIFICATIONS	ART. NO.	FOOD & BEVERAGES	WATER	CLINICAL	PHARMA	COSMETICS	ENVIRONMENTAL	MOLECULAR
500 g*	☐		02-263-500	●						
20 tubes with 9 ml	☐	Ink labelled tubes and metallic cap	064-TA0197	●						

KENNER FECAL AGAR (KF AGAR)

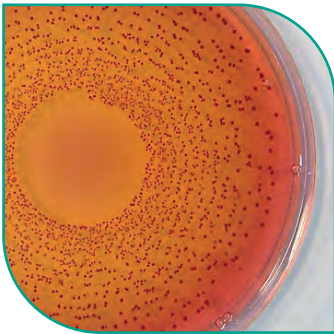

➤ KF AGAR

01-294
COMPF / SMWW

Solid and selective medium for enterococci enumeration and detection. Needs TTC Sterile Solution 1% (Art. No. 06-023).

PRESENTATION	TYPE OF PACKAGING	ART. NO.	FOOD & BEVERAGES	WATER	CLINICAL	PHARMA	COSMETICS	ENVIRONMENTAL	MOLECULAR
500 g*	☐	01-294-500	●	●					
TTC 1% Sterile Solution. 100 ml	☐	06-023-100	●	●					
30 plates of 55 mm Ø	☐	064-PF0701	●	●					

KF AGAR, see KENNER FECAL AGAR above

KIA, see KLIGLER IRON AGAR, page 70

KING A AGAR (P AGAR)

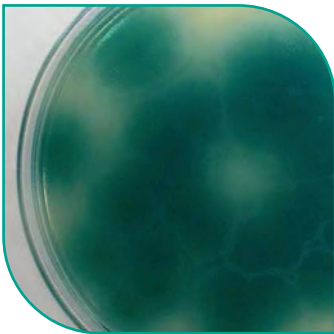

➤ PIGMENT PRODUCTION AGAR A
➤ PS MEDIUM A
➤ PSP

➤ TECH AGAR
➤ KING A MEDIUM

➤ PSEUDOMONAS AGAR MEDIUM FOR DETECTION OF PYOCYANIN
➤ P AGAR

01-001
ISO / USP

Solid medium to enhance the pyocyanin production by *Pseudomonas aeruginosa* according to ISO 16266 and 22717 standards. This medium needs to add glycerol (Art. No. GL0026100).

PRESENTATION	TYPE OF PACKAGING	ART. NO.	FOOD & BEVERAGES	WATER	CLINICAL	PHARMA	COSMETICS	ENVIRONMENTAL	MOLECULAR
500 g*	☐	01-001-500	●	●		●	●		
5x500 ml	☐	01-001BA05	●	●		●	●		
Glycerol (Additive). 1 litre	☐	GL00261000	●	●		●	●		

KING B AGAR (F AGAR)

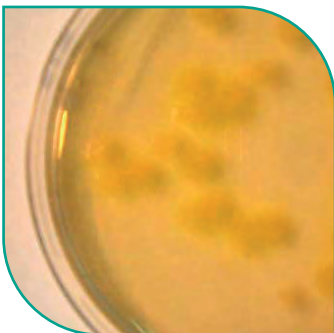

➤ PIGMENT PRODUCTION AGAR B
➤ PS MEDIUM B

➤ FLUORESCIN AGAR
➤ F AGAR

➤ FLO AGAR
➤ PSEUDOMONAS AGAR MEDIUM FOR DETECTION OF FLUORESCIN

01-029
DIN / EN / ISO / USP

Culture media for enhancing the fluorescein production by *Pseudomonas spp.* according to DIN 38411, EN 12780 and ISO 6266, 22717 standards. This medium needs to add glycerol (Art. No. GL00261000).

PRESENTATION	TYPE OF PACKAGING	ART. NO.	FOOD & BEVERAGES	WATER	CLINICAL	PHARMA	COSMETICS	ENVIRONMENTAL	MOLECULAR
500 g*	☐	01-029-500		●		●	●		
5x500 ml	☐	01-029BA05		●		●	●		
Glycerol (Additive). 1 litre	☐	GL00261000		●		●	●		

i *For dehydrated media presented in a 500 g package, we are able to offer other formats, including 5 and 25 kg. More information at: helpdesk@scharlab.com.

KLIGLER IRON AGAR (KIA)

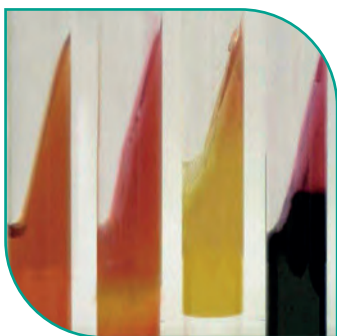

➤ KIA

➤ IRON AGAR

➤ KLIGLER'S IRON AGAR

01-103 ISO

Solid differential medium for primary identification of enterobacteria based on the fermentation of two sugars and the hydrogen sulfide production according to ISO 6340 standard.

PRESENTATION	TYPE OF PACKAGING	SPECIFICATIONS	ART. NO.	SECTOR						
				FOOD & BEVERAGES	WATER	CLINICAL	PHARMA	COSMETICS	ENVIRONMENTAL	MOLECULAR
500 g*	☐		01-103-500	●	●					
5x500 ml	☐		01-103BA05	●	●					
20 tubes with 7.5 ml of slanted agar	⌋	Metalic cap	064-TA0116	●	●					

LACTOSE BROTH



02-105

AOAC / COMPF / EP / ISO / SMWW / USP

Medium for pre-enrichment and detection of enterobacteria and coliforms in milk and water according to ISO 9308-2 and 21150 standards.

PRESENTATION	TYPE OF PACKAGING	SPECIFICATIONS	ART. NO.	SECTOR						
				FOOD & BEVERAGES	WATER	CLINICAL	PHARMA	COSMETICS	ENVIRONMENTAL	MOLECULAR
500 g*	☐		02-105-500	●	●	●	●	●		
5x500 ml	☐		02-105BA05	●	●	●	●	●		
10 flasks with 90 ml	☐	Aluminium screw outer cap + Elastomer inner septum and Durham tube	0BA3024-90	●	●	●	●	●		
10 flasks with 90 ml	☐	Injectable cap: Plastic screw inner cap + elastomer septum + protective outer cap + shrink wrapped plastic sleeve	0BA3029-90	●	●	●	●	●		
10 flasks with 90 ml	☐	Non injectable cap	0BA3929-90	●	●	●	●	●		
10 flasks with 100 ml	☐	Metalic-non injectable cap	064-BA3029	●	●	●	●	●		
20 tubes with 10 ml	⌋	Metalic-non injectable cap, double concentration with Durham tube	064-TA2141	●	●	●	●	●		
20 tubes with 10 ml	⌋	Metalic-non injectable cap and Durham tube	064-TA2142	●	●	●	●	●		

LACTOSE BROTH PHENOL RED (DOUBLE CONCENTRATION+ DURHAM TUBE)

064-BA7042

APHA / ISO / USP

Liquid culture medium, suitable for lactose fermentation studies according to ISO 9308-2 and 21150 standards. This medium contains double concentration and includes a Durham tube in each flask.

PRESENTATION	TYPE OF PACKAGING	SPECIFICATIONS	ART. NO.	SECTOR						
				FOOD & BEVERAGES	WATER	CLINICAL	PHARMA	COSMETICS	ENVIRONMENTAL	MOLECULAR
10 flasks with 50 ml	☐	Metalic-non injectable cap, double concentration and Durham tube	064-BA7042	●			●	●		

LACTOSE GELATIN MEDIUM

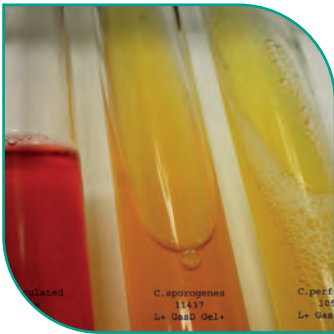

03-632 ISO

Solid medium used for the biochemical confirmation of *Clostridium perfringens*, according to ISO 7937 standard.

PRESENTATION	TYPE OF PACKAGING	ART. NO.	FOOD & BEVERAGES	WATER	CLINICAL	PHARMA	COSMETICS	ENVIRONMENTAL	MOLECULAR
500 g*	☐	03-632-500	●						

LACTOSE SULFITE BROTH BASE

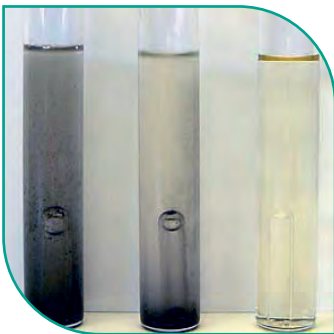

➤ CLS BASE

➤ MEDIUM R EUR. PHARM. 5TH ED.

02-519 ISO

Liquid medium for the determination of H₂S production by *Clostridium perfringens* according to ISO 7937 standard. This medium you need supplements:

- Sodium disulphite Selective Supplement (Art. No. 06-114LYO1): 1 vial per 500 ml of medium.
- Ammonium Ferric Citrate Supplement (312 mg) (Art. No. 06-113LYO1): 1 vial per 500 ml medium.

PRESENTATION	TYPE OF PACKAGING	SPECIFICATIONS	ART. NO.	FOOD & BEVERAGES	WATER	CLINICAL	PHARMA	COSMETICS	ENVIRONMENTAL	MOLECULAR
500 g*	☐		02-519-500	●			●			
20 tubes with 9 ml	↓	Ink labelled tubes and metallic-non injectable cap with Durham tube	064-TA0846	●			●			
Ferric Ammonium Citrate Supplement (312 mg). 10 vials	☐		06-113LYO1	●			●			
Sodium disulphite Selective Supplement. 10 vials	☐		06-114LYO1	●			●			

m-LAURYL SULFATE AGAR



01-524

Solid medium for the isolation and enumeration of coliform organisms and *E. coli* from water by membrane filtration.

PRESENTATION	TYPE OF PACKAGING	ART. NO.	FOOD & BEVERAGES	WATER	CLINICAL	PHARMA	COSMETICS	ENVIRONMENTAL	MOLECULAR
500 g*	☐	01-524-500		●					



*For dehydrated media presented in a 500 g package, we are able to offer other formats, including 5 and 25 kg. More information at: helpdesk@scharlab.com.

LAURYL SULFATE MUG BROTH



APHA / IDL / ISO

Liquid medium used for the detection and enumeration of coliform bacteria according to IDF-FIL 73B and ISO 4831 and 7251 standards.

PRESENTATION	TYPE OF PACKAGING	SPECIFICATIONS	ART. NO.	SECTOR
20 tubes with 9 ml	⊞	Ink labelled tubes with Durham tube and metallic-Non injectable cap	064-TA1260	FOOD & BEVERAGES WATER CLINICAL PHARMA COSMETICS ENVIRONMENTAL MOLECULAR

LB AGAR (MILLER)



01-385

Solid medium for general purposes and recommended for use in molecular genetics studies of *Escherichia coli*.

PRESENTATION	TYPE OF PACKAGING	ART. NO.	SECTOR
500 g*	⊞	01-385-500	FOOD & BEVERAGES WATER CLINICAL PHARMA COSMETICS ENVIRONMENTAL MOLECULAR
5x500 ml	⊞	01-385BA05	FOOD & BEVERAGES WATER CLINICAL PHARMA COSMETICS ENVIRONMENTAL MOLECULAR

LB BROTH



02-384

Liquid medium used for general purposes, especially recommended for molecular genetics studies of *Escherichia coli*.

PRESENTATION	TYPE OF PACKAGING	ART. NO.	SECTOR
500 g*	⊞	02-384-500	FOOD & BEVERAGES WATER CLINICAL PHARMA COSMETICS ENVIRONMENTAL MOLECULAR

LB BROTH (LENNOX)



02-406

Liquid medium used for general purposes, especially recommended for molecular genetics studies with *Escherichia coli*.

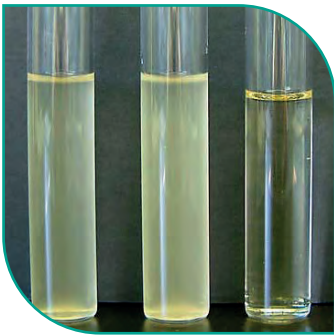

PRESENTATION	TYPE OF PACKAGING	ART. NO.	SECTOR
500 g*	⊞	02-406-500	FOOD & BEVERAGES WATER CLINICAL PHARMA COSMETICS ENVIRONMENTAL MOLECULAR

LB BROTH (MILLER)



02-385

Liquid medium for general purposes, recommended for molecular genetics studies of *Escherichia coli*.

PRESENTATION	TYPE OF PACKAGING	ART. NO.	SECTOR
500 g*		02-385-500	●
5x500 ml		02-385BA05	●

FOOD & BEVERAGES
WATER
CLINICAL
PHARMA
COSMETICS
ENVIRONMENTAL
MOLECULAR

LEGIONELLA SELECTIVE (GVPC) AGAR (ISO)

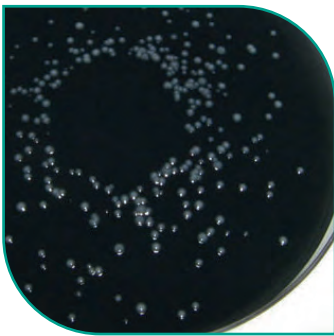





➤ CYE ➤ GVPC

064-PA0017
ISO

Solid medium base used for the detection, isolation and enumeration of *Legionella* from water according to the ISO standards 11731 and 11731-2. Needs Legionella GVPC Selective Supplement (Art. No. 06-138LY01). This medium contains cystein.

➤ See **BCYE Legionella Agar Base**, page 42.

PRESENTATION	TYPE OF PACKAGING	ART. NO.	SECTOR
500 g*		01-687-500	● ● ●
5x500 ml		01-687BA05	● ● ●
20 plates of 90 mm Ø		064-PA0017	● ● ●
Legionella BCYE Growth Supplement. 5 vials + 5 vials of solvent		06-137LY01	● ● ●
Legionella GVPC Selective Supplement. 10 vials		06-138LY01	● ● ●

FOOD & BEVERAGES
WATER
CLINICAL
PHARMA
COSMETICS
ENVIRONMENTAL
MOLECULAR

LETHEEN AGAR





➤ AOAC LETHEEN AGAR

➤ TGE W: LECITHIN W. TWEEN® 80

01-236
AOAC / ASTM / BAM

Solid medium for assays of antimicrobial action of Quaternary Ammonium Compounds (QAC's). Needs Polisorbate 80 additive (Art. No. TW0080).

PRESENTATION	TYPE OF PACKAGING	SPECIFICATIONS	ART. NO.	SECTOR
500 g*			01-236-500	●
10 flasks with 100 ml		Non injectable cap	064-BA3019	●
Polysorbate 80 (additive). 100 ml			TW00800100	●

FOOD & BEVERAGES
WATER
CLINICAL
PHARMA
COSMETICS
ENVIRONMENTAL
MOLECULAR



*For dehydrated media presented in a 500 g package, we are able to offer other formats, including 5 and 25 kg. More information at: helpdesk@scharlab.com.

LETHEEN BROTH

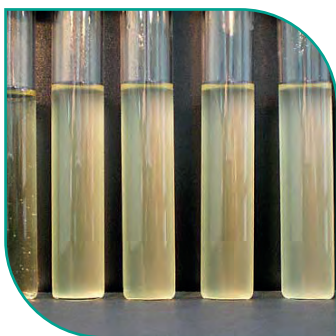

02-236

AOAC / ASTM

Liquid culture medium used for the determination of germicidal activity coefficients of cationic detergents. Needs Polysorbate 80 additive (Art. No. TW0080).

PRESENTATION	TYPE OF PACKAGING	SPECIFICATIONS	ART. NO.	SECTOR								
				FOOD & BEVERAGES	WATER	CLINICAL	PHARMA	COSMETICS	ENVIRONMENTAL	MOLECULAR		
500 g*	☐		02-236-500									
5x500 ml	☐		02-236BA05									
10 flasks with 100 ml	☐	Injectable cap: Plastic screw inner cap + elastomer septum + protective outer cap + shrink wrapped plastic sleeve	064-BA3018									
10 flasks with 450 ml	☐	Metalic-non injectable cap	064-BA5018									
20 tubes with 9 ml	☐	Ink labelled tubes and metallic cap	064-TA6100									
Polysorbate 80 (Additive). 100 ml	☐		TW00800100									

LETHEEN MODIFIED AGAR

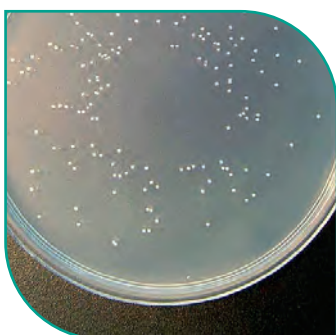

01-237

ASTM / BAM / FDA / ISO / USP

Solid medium for the primary screening of microorganisms in cosmetics according to the FDA and ISO 21149, 22717 and 22718 standards. Needs Polisorbate 80 additive (Art. No. TW0080).

PRESENTATION	TYPE OF PACKAGING	SPECIFICATIONS	ART. NO.	SECTOR								
				FOOD & BEVERAGES	WATER	CLINICAL	PHARMA	COSMETICS	ENVIRONMENTAL	MOLECULAR		
500 g*	☐		01-237-500									
5x500 ml	☐		01-237BA05									
20 plates of 90 mm Ø	☐		064-PA0047									
10 flasks with 100 ml	☐	Metalic-non injectable cap	064-BA8001									
10 flasks with 200 ml	☐	Injectable cap: Plastic screw inner cap. The use of syringes needles with a diameter greater than 0.8 mm is not recommended	064-BA1043									
Polysorbate 80 (additive). 100 ml	☐		TW00800100									

LETHEEN MODIFIED BROTH



02-237

ASTM / FDA / ISO / USP

FDA recommends liquid medium for the primary recovery of stressed microorganisms in the microbial examination of cosmetics. According to ISO 21149, 22717 and 22718 standards. Needs Polysorbate 80 additive (Art. No. TW0080).

PRESENTATION	TYPE OF PACKAGING	SPECIFICATIONS	ART. NO.	SECTOR								
				FOOD & BEVERAGES	WATER	CLINICAL	PHARMA	COSMETICS	ENVIRONMENTAL	MOLECULAR		
500 g*	☐		02-237-500									
5x500 ml	☐		02-237BA05									
10 flasks with 90 ml	☐	Injectable cap: Plastic screw inner cap + elastomer septum + protective outer cap + shrink wrapped plastic sleeve	0BA2145-90									
10 flasks with 300 ml	☐	Metalic-non injectable cap	064-BA8002									
20 tubes with 5 ml	☐	Ink labelled tubes and metallic cap	064-TA8283									
20 tubes with 9 ml	☐	Ink labelled tubes and metallic cap	064-TA6070									
Polysorbate 80 (additive). 100 ml	☐		TW00800100									

LETHEEN MODIFIED BROTH (FDA)



064-BA8017
FDA

Liquid medium for the primary recovery of stressed microorganisms in the microbial examination of cosmetics.

PRESENTATION	TYPE OF PACKAGING	SPECIFICATIONS	ART. NO.	SECTOR
10 flasks with 90 ml		Injectable cap: Plastic screw inner cap + elastomer septum + protective outer cap + shrink wrapped plastic sleeve	064-BA8017	● FOOD & BEVERAGES ● WATER ● CLINICAL ● PHARMA ● COSMETICS ● ENVIRONMENTAL ● MOLECULAR

LIA, see LYSINE IRON AGAR, page 78

LIEBERMEISTER & BRAVENY AGAR



01-446

Solid medium for the selective isolation of β -hemolytic streptococci in throat samples.

PRESENTATION	TYPE OF PACKAGING	ART. NO.	SECTOR
500 g*		01-446-500	● FOOD & BEVERAGES ● WATER ● CLINICAL ● PHARMA ● COSMETICS ● ENVIRONMENTAL ● MOLECULAR

LINDEN GRAIN BROTH

02-745

Liquid medium for media fill process simulation for beverage bottling, to test for low acid beverage spoiling microorganisms.

PRESENTATION	TYPE OF PACKAGING	ART. NO.	SECTOR
500 g*		02-745-500	● FOOD & BEVERAGES ● WATER ● CLINICAL ● PHARMA ● COSMETICS ● ENVIRONMENTAL ● MOLECULAR

LISTERIA ENRICHMENT BROTH BASE (LOVETT)

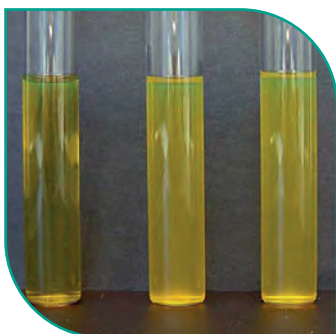

02-498

APHA / BAM / IDF

Liquid culture medium for the enrichment of *Listeria*, according to Lovett et al. Needs Listeria Supplement for Selective Enrichment according to FDA/IDF (Art. No. 06-107LYO1).

PRESENTATION	TYPE OF PACKAGING	ART. NO.	SECTOR
500 g*		02-498-500	● FOOD & BEVERAGES ● WATER ● CLINICAL ● PHARMA ● COSMETICS ● ENVIRONMENTAL ● MOLECULAR
5x500 ml		02-498BA05	● FOOD & BEVERAGES ● WATER ● CLINICAL ● PHARMA ● COSMETICS ● ENVIRONMENTAL ● MOLECULAR
Listeria FDA FIL/IDF Selective Supplement. 10 vials		06-107LYO1	● FOOD & BEVERAGES ● WATER ● CLINICAL ● PHARMA ● COSMETICS ● ENVIRONMENTAL ● MOLECULAR



*For dehydrated media presented in a 500 g package, we are able to offer other formats, including 5 and 25 kg. More information at: helpdesk@scharlab.com.

LISTERIA ENRICHMENT BROTH BASE (UVM)

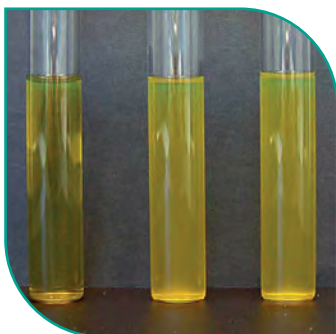

02-472 AOAC / APHA

Liquid culture medium for the enrichment of *Listeria spp.* This medium requires the addition of Listeria UVM I Selective Supplement (Art. No. 06-106LYO1) for primary enrichment or Listeria Selective Supplement (UVM II / Fraser) for secondary enrichment (Art. No. 06-111LYO1).

PRESENTATION	TYPE OF PACKAGING	ART. NO.	FOOD & BEVERAGES	WATER	CLINICAL	PHARMA	COSMETICS	ENVIRONMENTAL	MOLECULAR	SECTOR
500 g*	📦	02-472-500	●							
5x500 ml	📦	02-472BA05	●							
Listeria UVM I Selective Supplement. 10 vials.	📦	06-106LYO1	●							
Listeria Selective Supplement for Secondary Enrichment (UVM II / Fraser). 10 vials	📦	06-111LYO1	●							

LISTERIA ENRICHMENT BROTH FRASER



02-496 ISO

Liquid culture medium for primary enrichment and detection of *Listeria spp.* according to ISO 11290 standard. Supplements necessary to add to the base medium if you want to prepare for Enrichment Broth Base Listeria according Fraser:

- Listeria UVM II Selective Supplement (Art. No. 06-111LYO1): 1 vial to supplement 500 ml of broth.
- Ammonium Ferric Citrate Supplement (Art. No. 06-112LYO1): 1 vial to supplement 500 ml of broth, or
- Listeria Fraser / UVM II Selective Supplement (Art. No. 06-790LYO1): 1 vial to supplement 500 ml of broth (This supplement is ammonium ferric citrate included).

Medium preparations Fraser Listeria Enrichment Broth (Base) have included supplements.

If you want to prepare Media Listeria Half Concentration Enrichment Broth Fraser should add the following supplements:

- Half Fraser Listeria Selective Supplement - 225 ml (Art. No. 06-136LYO1): 1 vial to supplement 225 ml of broth, or
- Half Fraser Listeria Sel. Supplement - 500 ml (Art. No. 06-145LYO1): 1 vial to supplement 500 ml of broth.

Medium preparations Listeria Enrichment Broth Half Concentration Fraser have included supplements.

► **You must use connector (Art. No. 064-V70815) for bags.

PRESENTATION	TYPE OF PACKAGING	SPECIFICATIONS	ART. NO.	FOOD & BEVERAGES	WATER	CLINICAL	PHARMA	COSMETICS	ENVIRONMENTAL	MOLECULAR	SECTOR
500 g*	📦		02-496-500	●							
5x500 ml	📦		02-496BA05	●							
5 bags of Half Fraser Broth - 2 litres**	📦		064-BA02-2	●							
3 bags of Half Fraser Broth - 3 litres**	📦		064-BA02-3	●							
2 bags of Half Fraser Broth - 5 litres**	📦		064-BA02-5	●							
10 flasks of Fraser Broth - 225 ml	📦	White thermo resistant polypropylene cap	064-BA5001	●							
10 flasks of Half Fraser Broth - 225 ml	📦	White thermo resistant polypropylene cap	064-BA5002	●							
20 tubes of 10 ml	📦	Ink labelled tubes and metallic-non injectable cap	064-TA1125	●							
20 tubes of 9 ml	📦	Ink labelled tubes and metallic-non injectable cap	064-TA5002	●							
Listeria UVM II Selective Suppl. 10 vials	📦		06-111LYO1	●							
Ferric Ammonium Citrate Supplement. 10 vials	📦		06-112LYO1	●							
Listeria Half Fraser Selective Suppl. - 225 ml. 10 vials	📦	1 vial to supplement 225 ml of broth	06-136LYO1	●							
Listeria Half Fraser Selective Suppl. - 500 ml. 10 vials	📦	1 vial to supplement 500 ml of broth	06-145LYO1	●							
Listeria Fraser / UVM II Selective Supplement. 10 vials	📦		06-790LYO1	●							

LISTERIA OTTAVIANI & AGOSTI AGAR, see LISTERIA OTTAVIANI & AGOSTI AGAR MICROINSTANT® , page 130

LOVETT (LISTERIA ENRICHMENT BROTH BASE), see LISTERIA ENRICHMENT BROTH BASE (LOVETT), page 75

LÖWENSTEIN-JENSEN MEDIUM BASE



02-627

Medium for the culture and differentiation of species of *Mycobacterium spp.*

PRESENTATION	TYPE OF PACKAGING	SPECIFICATIONS	ART. NO.	SECTOR
500 g*	☐		02-627-500	●
20 tubes with 6.5 ml of slanted agar	⌋	Ink labelled tubes and metallic cap	064-TA0165	●

FOOD & BEVERAGES
WATER
CLINICAL
PHARMA
COSMETICS
ENVIRONMENTAL
MOLECULAR

LÖWENSTEIN-JENSEN PYRUVATE MEDIUM



064-TA0166

Medium supplemented with pyruvate for the culture and differentiation of species of *Mycobacterium*. It allows a good growth of *Mycobacterium bovis*.

PRESENTATION	TYPE OF PACKAGING	SPECIFICATIONS	ART. NO.	SECTOR
20 tubes with 6.5 ml of slanted agar	⌋	Ink labelled tubes and metallic cap	064-TA0166	●

FOOD & BEVERAGES
WATER
CLINICAL
PHARMA
COSMETICS
ENVIRONMENTAL
MOLECULAR

LST, see TRYPTOSE LAURYL SULFATE MODIFIED BASE BROTH, page 118

LYSINE AGAR



01-323

Synthetic and differential medium for the isolation, cultivation and enumeration of wild yeast in the brewing industry.

PRESENTATION	TYPE OF PACKAGING	SPECIFICATIONS	ART. NO.	SECTOR
500 g*	☐		01-323-500	●
10 flasks with 100 ml	⌋	Metallic-non injectable cap	064-BA1191	●

FOOD & BEVERAGES
WATER
CLINICAL
PHARMA
COSMETICS
ENVIRONMENTAL
MOLECULAR



*For dehydrated media presented in a 500 g package, we are able to offer other formats, including 5 and 25 kg. More information at: helpdesk@scharlab.com.

LYSINE IRON AGAR (LIA)

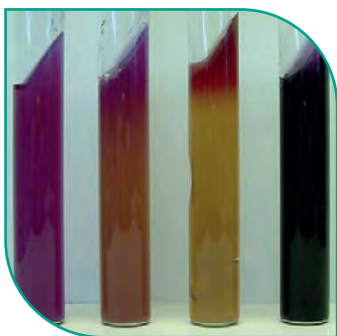

► LIA

01-094

AOAC / APHA / COMPF / SMD

Differential medium for Enterobacteria, recommended by Edwards and Ewing for *Salmonella* and *Arizona arizonae* (now known as *Salmonella choleraesuis* subsp. *arizonae*) identification.

PRESENTATION	TYPE OF PACKAGING	SPECIFICATIONS	ART. NO.	FOOD & BEVERAGES	WATER	CLINICAL	PHARMA	COSMETICS	ENVIRONMENTAL	MOLECULAR
500 g*	☐		01-094-500	●		●				
5x500 ml	☐		01-094BA05	●		●				
20 tubes with 7.5 ml of slanted agar	⌋	Ink labelled tubes and metallic cap	064-TA0117	●		●				

M17 AGAR

01-245

IDF / ISO

Solid selective medium for the enumeration of *Streptococcus thermophilus* in yoghurt samples according to ISO 7889 and 9232 and IDF 117 and 146 standards.

PRESENTATION	TYPE OF PACKAGING	SPECIFICATIONS	ART. NO.	FOOD & BEVERAGES	WATER	CLINICAL	PHARMA	COSMETICS	ENVIRONMENTAL	MOLECULAR
500 g*	☐		01-245-500	●						
10 flasks with 100 ml	⌋	Metalic-non injectable cap	064-BA8003	●						

MACCONKEY AGAR (EUR. PHARM.)

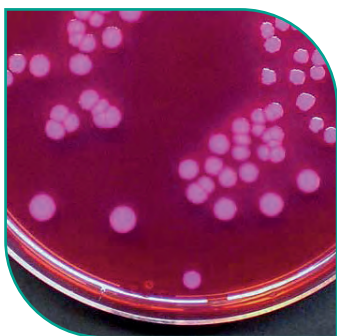

01-118

AOAC / BAM / COMPF / EP / HP / ISO / SMWW / USP

Selective and differential medium used in the detection, isolation and enumeration of *Salmonella* and coliforms in clinical specimens according to the Pharmacopoea Harmonized Methodology and in foodstuffs specimens according to ISO 21150 standard.

PRESENTATION	TYPE OF PACKAGING	SPECIFICATIONS	ART. NO.	FOOD & BEVERAGES	WATER	CLINICAL	PHARMA	COSMETICS	ENVIRONMENTAL	MOLECULAR
500 g*	☐		01-118-500	●	●	●	●			●
5x500 ml	☐		01-118BA05	●	●	●	●			●
20 plates of 90 mm Ø	☉		064-PA0019	●	●	●	●	●		●
30 contact plates	☒		064-PR0011	●	●	●	●	●		●
10 flasks with 100 ml	⌋	Non injectable cap	064-BA1003	●	●	●	●	●		●
9 flasks with 450 ml	⌋	Metalic-non injectable cap	064-BA8038	●	●	●	●	●		●

MACCONKEY BROTH

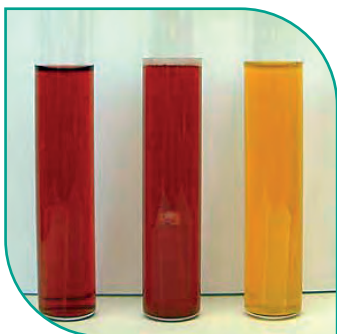

02-118

AOAC / ISO / SMWW

Liquid medium used for the detection and enumeration of coliforms by MPN technique.

PRESENTATION	TYPE OF PACKAGING	ART. NO.	FOOD & BEVERAGES	WATER	CLINICAL	PHARMA	COSMETICS	ENVIRONMENTAL	MOLECULAR
500 g*	☐	02-118-500	●	●					●
5x500 ml	☐	02-118BA05	●	●					●

MACCONKEY BROTH (EUR. PHARM.)



➤ MEDIUM G

➤ MEDIUM G EUR. PHARM. 5TH ED.

➤ MEDIUM 6

02-611
EP / HP / USP

Liquid medium, for the detection and enumeration of coliforms, according to the Pharmacopeial Harmonised Method.

PRESENTATION	TYPE OF PACKAGING	SPECIFICATIONS	ART. NO.	FOOD & BEVERAGES	WATER	CLINICAL	PHARMA	COSMETICS	ENVIRONMENTAL	MOLECULAR
500 g*	☐		02-611-500	●	●		●			
5x500 ml	☐		02-611BA05	●	●		●			
10 flasks with 100 ml	☐	Metalic-non injectable cap	064-BA2143	●	●		●			
20 tubes with 9 ml	↑	Ink labelled tubes with Durham tube and metallic-Non injectable cap	064-TA2135	●	●		●			

MACCONKEY NO. 2 AGAR



01-682

A modification of MacConkey Agar containing bile salts No. 2 for the identification of enterococci.

PRESENTATION	TYPE OF PACKAGING	ART. NO.	FOOD & BEVERAGES	WATER	CLINICAL	PHARMA	COSMETICS	ENVIRONMENTAL	MOLECULAR
500 g*	☐	01-682-500	●	●					

MACCONKEY SORBITOL AGAR (MODIFIED)

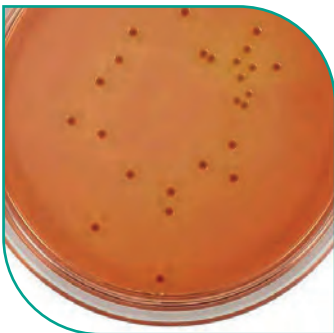

➤ SMAC AGAR

01-729
FDA / ISO

Selective and differential solid medium for the detection of Enterohaemorrhagic *Escherichia coli* (EHEC O157: H7) according to ISO 16654 standard.

To obtain the CT-SMAC Agar (according to ISO 16654 standard) add CT SMAC Selective Supplement (Art. No. 06-146LYO1).

PRESENTATION	TYPE OF PACKAGING	ART. NO.	FOOD & BEVERAGES	WATER	CLINICAL	PHARMA	COSMETICS	ENVIRONMENTAL	MOLECULAR
500 g*	☐	01-729-500	●						
5x500 ml	☐	01-729BA05	●						
CT SMAC Selective supplement. 10 vials	☐	06-146LYO1	●						

MALT EXTRACT AGAR (BLAKESLEE)

01-672
IFU

Solid medium to achieve typical growth and sporulation of fungi according to methodology of CBS and IFU.

PRESENTATION	TYPE OF PACKAGING	ART. NO.	FOOD & BEVERAGES	WATER	CLINICAL	PHARMA	COSMETICS	ENVIRONMENTAL	MOLECULAR
500 g*	☐	01-672-500	●						



*For dehydrated media presented in a 500 g package, we are able to offer other formats, including 5 and 25 kg. More information at: helpdesk@scharlab.com.

MALT EXTRACT AGAR NO. 1



01-111 BAM / COMPF

Solid culture medium for the isolation and enumeration of fungi, with gelatin peptone.

PRESENTATION	TYPE OF PACKAGING	ART. NO.	FOOD & BEVERAGES	WATER	CLINICAL	PHARMA	COSMETICS	ENVIRONMENTAL	MOLECULAR
500 g*	☐	01-111-500	●						
5x500 ml	☐	01-111BA05	●						

MALT EXTRACT AGAR NO. 2

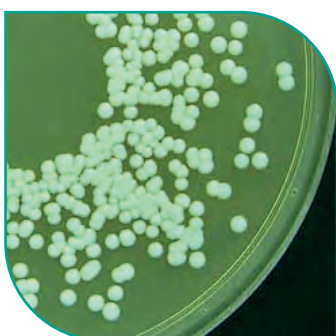

01-573

Solid culture medium for the isolation and enumeration of fungi, with soy peptone.

PRESENTATION	TYPE OF PACKAGING	ART. NO.	FOOD & BEVERAGES	WATER	CLINICAL	PHARMA	COSMETICS	ENVIRONMENTAL	MOLECULAR
500 g*	☐	01-573-500	●					●	
5x500 ml	☐	01-573BA05	●					●	

MALT EXTRACT AGAR NO. 3

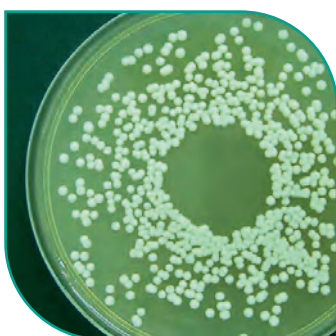

01-574 BAM

Solid culture medium for the isolation and enumeration of fungi, with mycological peptone.

PRESENTATION	TYPE OF PACKAGING	SPECIFICATIONS	ART. NO.	FOOD & BEVERAGES	WATER	CLINICAL	PHARMA	COSMETICS	ENVIRONMENTAL	MOLECULAR
500 g*	☐		01-574-500	●					●	
20 plates of 90 mm Ø	☉		064-PA0027	●					●	
30 contact plates	☐☐☐		064-PR0031	●					●	
10 flasks with 100 ml	☒	Metalic-non injectable cap	064-BA7036	●					●	

MALT EXTRACT BROTH NO. 1

02-111 BAM / COMPF

Liquid medium for moulds and yeast.

PRESENTATION	TYPE OF PACKAGING	ART. NO.	FOOD & BEVERAGES	WATER	CLINICAL	PHARMA	COSMETICS	ENVIRONMENTAL	MOLECULAR
500 g*	☐	02-111-500	●						

MALT EXTRACT BROTH NO. 2



02-491

Liquid culture medium for yeasts and moulds according to the modification of Reis for *Aspergillus flavus*.

PRESENTATION	TYPE OF PACKAGING	ART. NO.	FOOD & BEVERAGES	WATER	CLINICAL	PHARMA	COSMETICS	ENVIRONMENTAL	MOLECULAR
500 g*	☐	02-491-500	●						

MANNITOL MOTILITY TEST



064-TA0159

Medium for the verification of motility and mannitol fermentation in enterobacteria.

PRESENTATION	TYPE OF PACKAGING	SPECIFICATIONS	ART. NO.	FOOD & BEVERAGES	WATER	CLINICAL	PHARMA	COSMETICS	ENVIRONMENTAL	MOLECULAR
20 tubes with 9 ml	⌋	Ink labelled tubes and metallic cap	064-TA0159							●

MANNITOL SALT AGAR, see CHAPMAN AGAR, page 53

MARINE AGAR



01-291

Solid culture medium for heterotrophic marine bacteria.

PRESENTATION	TYPE OF PACKAGING	ART. NO.	FOOD & BEVERAGES	WATER	CLINICAL	PHARMA	COSMETICS	ENVIRONMENTAL	MOLECULAR
500 g*	☐	01-291-500	●	●					



*For dehydrated media presented in a 500 g package, we are able to offer other formats, including 5 and 25 kg. More information at: helpdesk@scharlab.com.

MAXIMUM RECOVERY DILUENT (MRD)



- UNIVERSAL DILUENT ► MRD ► SALINE PEPTONE WATER

02-510 ISO

Isotonic diluent for the maximal recovery of stressed microorganisms according to ISO 6887-1, 8261, 21149, 21150, 22717 and 22718 standards.

- **You must use connector (Art. No. 064-V70815) for bags.

PRESENTATION	TYPE OF PACKAGING	SPECIFICATIONS	ART. NO.	SECTOR						
				FOOD & BEVERAGES	WATER	CLINICAL	PHARMA	COSMETICS	ENVIRONMENTAL	MOLECULAR
500 g*	☐		02-510-500	●	●		●			
5x500 ml	☐		02-510BA05	●	●		●			
3 bags of 3 litres**	☐		064-BA04-3	●	●		●			
2 bags of 5 litres**	☐		064-BA04-5	●	●		●			
10 flasks with 90 ml	☐	Injectable cap: Plastic screw inner cap + elastomer septum + protective outer cap + shrink wrapped plastic sleeve	064-BA0733	●	●		●			
20 tubes with 9 ml	↑	Ink labelled tubes and metallic cap	064-TA6074	●	●		●			

METHYL RED VOGES PROSKAUER BROTH (MRVP BROTH)



- CLARKS LUBS MEDIUM ► MRVP BROTH

02-207 AOAC / BAM / IDF / ISO / SL

Classic liquid medium used for differential tests (Voges-Proskauer and Methyl Red) in Enterobacteriaceae according to ISO 6579, 6585 and FIL-IDF 181 standards.

PRESENTATION	TYPE OF PACKAGING	SPECIFICATIONS	ART. NO.	SECTOR						
				FOOD & BEVERAGES	WATER	CLINICAL	PHARMA	COSMETICS	ENVIRONMENTAL	MOLECULAR
500 g*	☐		02-207-500	●		●				
5x500 ml	☐		02-207BA05	●		●				
20 tubes with 10 ml	↑	Ink labelled tubes and metallic cap	064-TA0261	●		●				

METHYL RED VOGES PROSKAUER SALINE BROTH

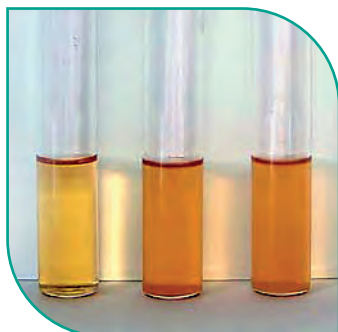

- MRVP SALINE BROTH

02-456

Liquid culture medium for Methyl Red and Voges-Proskauer (VP) tests in marine bacteria.

PRESENTATION	TYPE OF PACKAGING	ART. NO.	SECTOR						
			FOOD & BEVERAGES	WATER	CLINICAL	PHARMA	COSMETICS	ENVIRONMENTAL	MOLECULAR
500 g*	☐	02-456-500	●						

m-FC AGAR, see FECAL COLIFORMS AGAR, page 62



*For dehydrated media presented in a 500 g package, we are able to offer other formats, including 5 and 25 kg. More information at: helpdesk@scharlab.com.

MICROBIAL CONTENT TEST AGAR

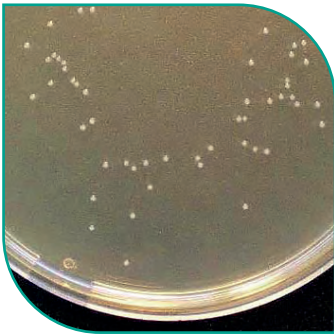

➤ TSA WITH LECITHIN AND TWEEN®

➤ TSA LECITHIN & POLYSORBATE

01-613
APHA / COMPF / SMD

Solid medium for sampling of surfaces of sanitary importance with contact plates technique.

PRESENTATION	TYPE OF PACKAGING	ART. NO.	FOOD & BEVERAGES	WATER	CLINICAL	PHARMA	COSMETICS	ENVIRONMENTAL	MOLECULAR
500 g*	☐	01-613-500					●	●	
5x500 ml	☐	01-613BA05					●	●	

MINERAL MODIFIED GLUTAMATE AGAR BASE



01-659
APHA / COMPF / IDF / ISO

Solid medium for resuscitation and recovery of *Escherichia coli* damaged cells by heat, freezing or chemical process according to FIL-IDF and ISO 11866-2 and 16649-1 standards. Needs ammonium chloride (Art. No. AM0273) and Sodium Glutamate (Art. No. SO0400) additives.

PRESENTATION	TYPE OF PACKAGING	ART. NO.	FOOD & BEVERAGES	WATER	CLINICAL	PHARMA	COSMETICS	ENVIRONMENTAL	MOLECULAR
500 g*	☐	01-659-500	●						
5x500 ml	☐	01-659BA05	●						
Ammonium chloride (Additive), 500 g	☐	AM02730500	●						
Sodium glutamate (Additive), 500 g	☐	SO04000500	●						

MINERAL MODIFIED GLUTAMATE MEDIUM BASE



02-656
ISO

Liquid medium for the selective enrichment of *E. coli* according to ISO 16649-3 standard. Needs ammonium chloride (Art. No. AM0273) and monosodium glutamate (Art. No. SO0400) additives.

PRESENTATION	TYPE OF PACKAGING	SPECIFICATIONS	ART. NO.	FOOD & BEVERAGES	WATER	CLINICAL	PHARMA	COSMETICS	ENVIRONMENTAL	MOLECULAR
500 g*	☐		02-656-500	●						
5x500 ml	☐		02-656BA05	●						
20 tubes with 10 ml	☐	Ink labelled tubes and metallic-non injectable cap, with Durham tubes	064-TA8312	●						
20 tubes with 10 ml	☐	Ink labelled tubes and metallic-non injectable cap, double concentration with Durham tubes	064-TA8311	●						
Ammonium chloride (Additive), 500 g	☐		AM02730500	●						
Sodium glutamate (Additive), 500 g	☐		SO04000500	●						

MIO FLUID MEDIUM, see MOTILITY INDOL ORNITHINE FLUID MEDIUM, page 84

*For dehydrated media presented in a 500 g package, we are able to offer other formats, including 5 and 25 kg. More information at: helpdesk@scharlab.com.

MOTILITY INDOL ORNITHINE FLUID MEDIUM (MIO)

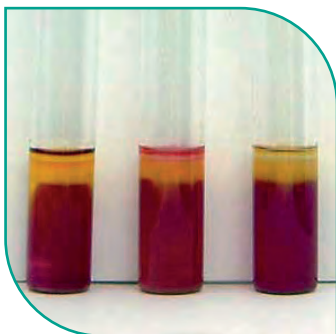

► MIO

03-422
BAM

Medium used for the demonstration of motility, indol production and the ornithine-decarboxylase activity of enterobacteria.

PRESENTATION	TYPE OF PACKAGING	SPECIFICATIONS	ART. NO.	SECTOR
500 g*	☐		03-422-500	●
20 tubes with 9 ml	↓	Ink labelled tubes and metallic cap	064-TA0119	●

FOOD & BEVERAGES
WATER
CLINICAL
PHARMA
COSMETICS
ENVIRONMENTAL
MOLECULAR

MOTILITY INDOLE UREA



064-TA2170

Semisolid medium used for the identification of members of the family Enterobacteriaceae by detecting motility, indole and urea.

PRESENTATION	TYPE OF PACKAGING	SPECIFICATIONS	ART. NO.	SECTOR
20 tubes with 9 ml	↓	Ink labelled tubes and metallic cap	064-TA2170	● ●

FOOD & BEVERAGES
WATER
CLINICAL
PHARMA
COSMETICS
ENVIRONMENTAL
MOLECULAR

MOTILITY NITRATE MEDIUM



03-612
BAM / FDA / ISO

Fluid medium used for the identification of *Clostridium perfringens* according to ISO 7937 standard.

PRESENTATION	TYPE OF PACKAGING	ART. NO.	SECTOR
500 g*	☐	03-612-500	●
5x500 ml	☐	03-612BA05	●
Glycerol (Additive). 1 litre	☐	GL00261000	●

FOOD & BEVERAGES
WATER
CLINICAL
PHARMA
COSMETICS
ENVIRONMENTAL
MOLECULAR

MRD, see MAXIMUM RECOVERY DILUENT, page 82

MRS AGAR



► LACTOBACILLI MRS AGAR

01-135
ISO

Solid culture medium for detection, isolation and cultivation of lactobacilli and other lactic acid bacteria from food and beverages according to de Man, Rogosa and Sharpe according to ISO 9332 and 15214 standards.

PRESENTATION	TYPE OF PACKAGING	SPECIFICATIONS	ART. NO.	FOOD & BEVERAGES	WATER	CLINICAL	PHARMA	COSMETICS	ENVIRONMENTAL	MOLECULAR
500 g*	☐		01-135-500	●					●	
5x500 ml	☐		01-135BA05	●					●	
20 plates of 90 mm Ø	☉		064-PA0007	●					●	
10 flasks with 100 ml	☒	Metalic-non injectable cap	064-BA2130	●					●	
10 flasks with 200 ml	☒	Metalic-non injectable cap	064-BA0582	●					●	

MRS AGAR (ISO)

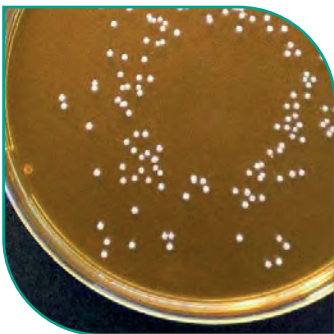

01-803
IDF / IFU / ISO

Solid medium for the culture of lactic acid bacteria according to de Man, Rogosa and Sharpe, modified according to ISO 9232, 15214 and 20128 standards and IFU No. 5 and 9 methods.

PRESENTATION	TYPE OF PACKAGING	ART. NO.	FOOD & BEVERAGES	WATER	CLINICAL	PHARMA	COSMETICS	ENVIRONMENTAL	MOLECULAR
500 g*	☐	01-803-500	●						

MRS BROTH



► LACTOBACILLI MRS BROTH

► MAN ROGOSE SHARPE BROTH

02-135
IDF / IFU / ISO

Liquid culture medium for the isolation of lactobacilli, according to de Man, Rogosa and Sharpe according to ISO 9232 standard.

PRESENTATION	TYPE OF PACKAGING	SPECIFICATIONS	ART. NO.	FOOD & BEVERAGES	WATER	CLINICAL	PHARMA	COSMETICS	ENVIRONMENTAL	MOLECULAR
500 g*	☐		02-135-500	●	●	●				
5x500 ml	☐		02-135BA05	●	●	●				
20 tubes with 9 ml	☒		064-TA8300	●	●	●				
20 tubes with 10 ml	☒	Ink labelled tubes and metallic-non injectable cap	064-TA0173	●	●	●				



*For dehydrated media presented in a 500 g package, we are able to offer other formats, including 5 and 25 kg. More information at: helpdesk@scharlab.com.

MRS, BROTH (NON PORCINE ORIGEN)



02-135H
ISO

Liquid culture medium for enrichment of lactobacilli without derivatives of porcine animal origin according to ISO 9232 standard.

PRESENTATION	TYPE OF PACKAGING	ART. NO.	FOOD & BEVERAGES	WATER	CLINICAL	PHARMA	COSMETICS	ENVIRONMENTAL	MOLECULAR
500 g*	☐	02-135H500	●						

MRVP BROTH, see METHYL RED VOGES PROSKAUER BROTH, page 82

MRVP SALINE BROTH, see METHYL RED VOGES PROSKAUER SALINE BROTH, page 82

MSRV, see RAPPAPORT VASSILIADIS MODIFIED SEMISOLID MEDIUM BASE, page 98

MUELLER-HINTON AGAR

► M-H AGAR

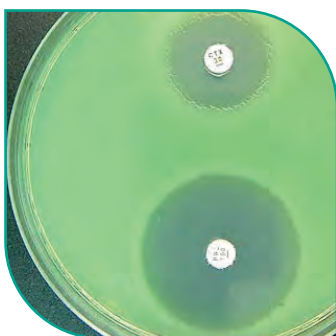

01-136
BAM / CLSI (NCCLS)

Recommended medium used to perform Antibiotic and Sulphonamide sensitivity testing with pathogenic microorganisms from clinical specimens, according to the Kirby-Bauer and Ericsson methodology.

PRESENTATION	TYPE OF PACKAGING	SPECIFICATIONS	ART. NO.	FOOD & BEVERAGES	WATER	CLINICAL	PHARMA	COSMETICS	ENVIRONMENTAL	MOLECULAR
500 g*	☐		01-136-500			●	●			
5x500 ml	☐		01-136BA05			●	●			
20 plates of 90 mm Ø	☉		064-PA0020			●	●			
10 flasks with 100 ml	☒	Non injectable cap	064-BA1004			●	●			

MUELLER-HINTON BLOOD AGAR



064-PA0021
BAM / CLSI

Widely recommended medium for antibiotic and Sulphonamides susceptibility testing, according to the Kirby-Bauer and the Ericsson methods.

PRESENTATION	TYPE OF PACKAGING	ART. NO.	FOOD & BEVERAGES	WATER	CLINICAL	PHARMA	COSMETICS	ENVIRONMENTAL	MOLECULAR
20 plates of 90 mm Ø	☉	064-PA0021			●	●			

MUELLER-HINTON BROTH



02-136
CLSI (NCCLS) / CMPH

Liquid version of the agar, recommended for studies of antibiotic MIC (Minimum Inhibitory Concentration).

PRESENTATION	TYPE OF PACKAGING	ART. NO.	SECTOR
500 g*	☐	02-136-500	●
5x500 ml	☐	02-136BA05	●

FOOD & BEVERAGES
WATER
CLINICAL
PHARMA
COSMETICS
ENVIRONMENTAL
MOLECULAR

**MÜLLER-KAUFFMANN
TETRATHIONATE
BROTH BASE**

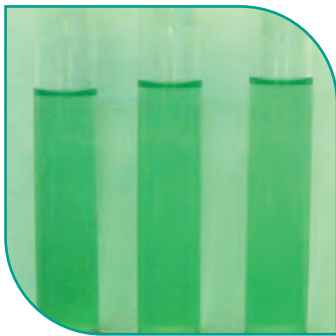

➤ MKTTN ➤ TETRATHIONATE ACCORDING TO MÜLLER-KAUFFMANN BROTH

02-335
DIN / FDA / IDF / ISO / USP

Medium used for the selective enrichment of salmonellae, according to ISO 6579, 6785 and 3565 standards. Needs an iodine/iodide solution (Art. No. 064-V11108) and Brilliant Green-Novobiocin (Art. No. 06-017LY01) Selective Supplement.

PRESENTATION	TYPE OF PACKAGING	SPECIFICATIONS	ART. NO.	SECTOR
500 g*	☐		02-335-500	●
5x500 ml	☐		02-335BA05	●
10 flasks with 100 ml	☐	Non injectable cap	064-BA1024	●
20 tubes with 10 ml	☐	Ink labelled tubes and metallic-non injectable cap	064-TA1024	●
Brilliant Green Selective Supplement with Novobiocin. 10 vials	☐		06-017LY01	●
Iodine potassium iodide solution (To be added to the prepared medium). 50 ml	☐	1 box with a bottle 60 ml. Topaz	064-V11108	●

FOOD & BEVERAGES
WATER
CLINICAL
PHARMA
COSMETICS
ENVIRONMENTAL
MOLECULAR

MYP AGAR, see BACILLUS CEREUS AGAR, page 40

**NEUTRALIZING
BROTH (APHA)**



064-BA7051
APHA / EP / USP

Diluent with neutralisers for the homogenization of samples according to the American Public Health Association.

PRESENTATION	TYPE OF PACKAGING	SPECIFICATIONS	ART. NO.	SECTOR
10 flasks with 200 ml	☐	Injectable cap: Plastic screw inner cap + elastomer septum + protective outer cap + shrink wrapped plastic sleeve	064-BA7051	●

FOOD & BEVERAGES
WATER
CLINICAL
PHARMA
COSMETICS
ENVIRONMENTAL
MOLECULAR

*For dehydrated media presented in a 500 g package, we are able to offer other formats, including 5 and 25 kg. More information at: helpdesk@scharlab.com.

NEUTRALIZING FLUID



02-512 EP

Liquid medium for neutralizing antimicrobials, according to the European Pharmacopoeia. Needs Polysorbate 80 (Art. No. TW0080) additive.

PRESENTATION	TYPE OF PACKAGING	ART. NO.	SECTOR							
			FOOD & BEVERAGES	WATER	CLINICAL	PHARMA	COSMETICS	ENVIRONMENTAL	MOLECULAR	
500 g*	☐	02-512-500				●				
5x500 ml	☐	02-512BA05				●				
Polysorbate 80 (Additive). 100 ml	☐	TW00800100				●				

NEUTRALIZING SPECIAL BROTH

02-583

Liquid medium used for the neutralisation of preservatives in cosmetics and pharmaceutical products. Needs Polysorbate 80 (Art. No. TW0080) additive.

PRESENTATION	TYPE OF PACKAGING	ART. NO.	SECTOR							
			FOOD & BEVERAGES	WATER	CLINICAL	PHARMA	COSMETICS	ENVIRONMENTAL	MOLECULAR	
500 g*	☐	02-583-500				●	●			
Polysorbate 80 (Additive). 100 ml	☐	TW00800100				●	●			

NICKERSON AGAR

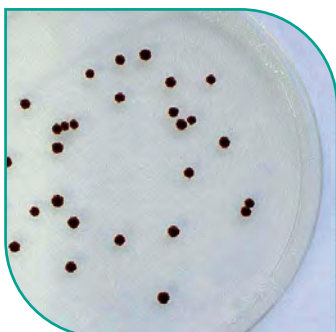

➤ BIGGY AGAR ➤ NICKERSON AGAR ➤ BISMUTH GLYCINE GLUCOSE YEAST AGAR ➤ NICKERSON CANDIDA SELECTIVE AGAR

01-137

Culture medium for the isolation and identification of *Candida* spp.

PRESENTATION	TYPE OF PACKAGING	ART. NO.	SECTOR							
			FOOD & BEVERAGES	WATER	CLINICAL	PHARMA	COSMETICS	ENVIRONMENTAL	MOLECULAR	
500 g*	☐	01-137-500			●		●			
5x500 ml	☐	01-137BA05			●		●			
20 plates of 90 mm Ø	☐	064-PA0018			●		●			

NITRATE BROTH

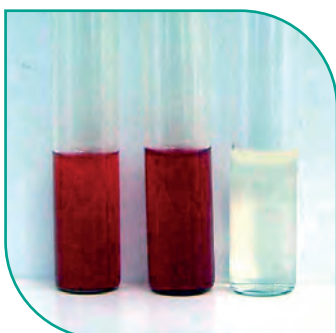

02-138 BAM / COMPF / ISO

Liquid culture medium used for verifying the nitrate reducing ability of enterobacteria according to ISO 7932 standard.

PRESENTATION	TYPE OF PACKAGING	ART. NO.	SECTOR							
			FOOD & BEVERAGES	WATER	CLINICAL	PHARMA	COSMETICS	ENVIRONMENTAL	MOLECULAR	
500 g*	☐	02-138-500	●							
20 tubes of 10 ml	☐	064-TA0128	●							

NUTRIENT AGAR

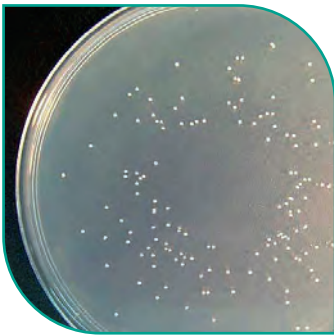

01-140 BAM / BP / EN / ISO

Solid culture medium for general purpose use with less fastidious organisms according to ISO 8914-1, 16266 and EN 12780 standards.

PRESENTATION	TYPE OF PACKAGING	SPECIFICATIONS	ART. NO.	FOOD & BEVERAGES	WATER	CLINICAL	PHARMA	COSMETICS	ENVIRONMENTAL	MOLECULAR
500 g*			01-140-500	●	●	●	●			
5x500 ml			01-140BA05	●	●	●	●			
20 plates of 90 mm Ø			064-PA0059	●	●	●	●			
30 plates of 55 mm Ø			064-PF0001	●	●	●	●			
10 flasks with 100 ml		Metallic-non injectable cap	064-BA1035	●	●	●	●			
20 tubes with 15 ml		Ink labelled tubes and metallic-non injectable cap	064-TA2144	●	●	●	●			

NUTRIENT AGAR (APHA, ISO)

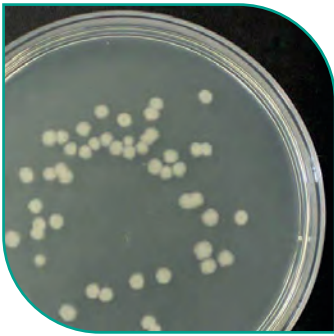

01-144 COMPF / EP / ISO

Solid culture medium for general purpose use according to ISO 6579, 6785 and 10273 standards and APHA.

PRESENTATION	TYPE OF PACKAGING	ART. NO.	FOOD & BEVERAGES	WATER	CLINICAL	PHARMA	COSMETICS	ENVIRONMENTAL	MOLECULAR
500 g*		01-144-500	●	●			●		
5x500 ml		01-144BA05	●	●			●		

NUTRIENT AGAR (ISO)

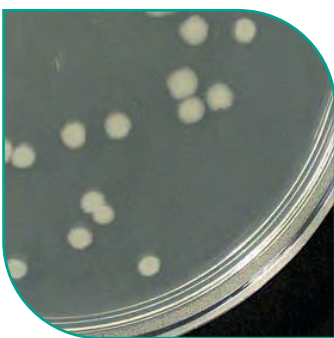

01-635 ISO

General purpose solid culture medium according to ISO 21528 standard.

PRESENTATION	TYPE OF PACKAGING	ART. NO.	FOOD & BEVERAGES	WATER	CLINICAL	PHARMA	COSMETICS	ENVIRONMENTAL	MOLECULAR
500 g*		01-635-500	●						
5x500 ml		01-635BA05	●						

NUTRIENT BROTH (APHA)



02-144 APHA / ISO

A general purpose liquid culture medium for non-fastidious microorganisms according to APHA and ISO 6340, 6569, 6785, 8523, 10273 and 16266 standards.

PRESENTATION	TYPE OF PACKAGING	ART. NO.	FOOD & BEVERAGES	WATER	CLINICAL	PHARMA	COSMETICS	ENVIRONMENTAL	MOLECULAR
500 g*		02-144-500	●	●		●			
5x500 ml		02-144BA05	●	●		●			





*For dehydrated media presented in a 500 g package, we are able to offer other formats, including 5 and 25 kg. More information at: helpdesk@scharlab.com.

NUTRIENT BROTH (B.P.H.)



02-140
BP

A general purpose liquid culture medium for non-fastidious microorganisms, according to the British Pharmacopoeia.

PRESENTATION	TYPE OF PACKAGING	ART. NO.	SECTOR
500 g*		02-140-500	●
5x500 ml		02-140BA05	●

FOOD & BEVERAGES
WATER
CLINICAL
PHARMA
COSMETICS
ENVIRONMENTAL
MOLECULAR

NUTRITIVE NO. 1 BROTH

02-501

Liquid medium for cultivation of fastidious bacteria.

PRESENTATION	TYPE OF PACKAGING	ART. NO.	SECTOR
500 g*		02-501-500	● ● ●

FOOD & BEVERAGES
WATER
CLINICAL
PHARMA
COSMETICS
ENVIRONMENTAL
MOLECULAR

O/F MEDIUM see OXIDATION-FERMENTATION FLUID MEDIUM BASE, page 91

OFBBL AGAR, see Burkholderia cepacia SELECTIVE AGAR BASE, page 51

OGYEA, see SABOURAUD OXYTETRACYCLINE AGAR, page 104



ORANGE SERUM AGAR

► OSA



01-698
IFU

Solid medium for the culture of aciduric organisms especially those associated with the spoilage of citrus products and their derivatives according to IFU Method No 2, 6, 7 and 10 standards.

PRESENTATION	TYPE OF PACKAGING	SPECIFICATIONS	ART. NO.	SECTOR
500 g*			01-698-500	●
20 plates of 90 mm Ø			064-PA7035	●
10 flasks with 200 ml		Metalic-non injectable cap	064-BA7161	●

FOOD & BEVERAGES
WATER
CLINICAL
PHARMA
COSMETICS
ENVIRONMENTAL
MOLECULAR

OXFORD AGAR BASE

01-471
ISO

Solid, selective and differential medium for the detection, enumeration and isolation of *Listeria spp.* according to ISO 11290-1 and 11290-2 standards. This medium need to add Oxford Agar Selective Supplement (Art. No. 06-127LYO1).

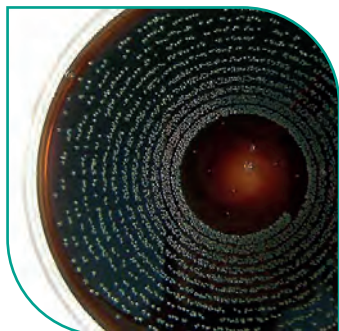

PRESENTATION	TYPE OF PACKAGING	ART. NO.	SECTOR
500 g*		01-471-500	●
5x500 ml		01-471BA05	●
Oxford Selective Supplement. 10 vials		06-127LYO1	●

FOOD & BEVERAGES
WATER
CLINICAL
PHARMA
COSMETICS
ENVIRONMENTAL
MOLECULAR



*For dehydrated media presented in a 500 g package, we are able to offer other formats, including 5 and 25 kg. More information at: helpdesk@scharlab.com.

OXIDATION-FERMENTATION FLUID MEDIUM BASE (O/F MEDIUM)

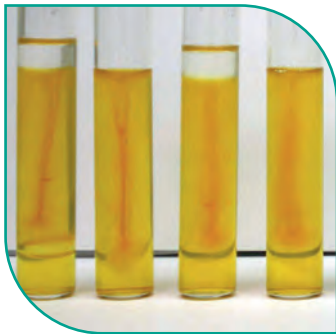

- O/F ENTERIC MEDIUM
- O/F MEDIUM

- O/F BASAL MEDIUM ACCORDING TO HUGH & LEIFSON
- HUGH & LEIFSON MEDIUM

03-037
AOAC / BAM / CMPH / COMPF

Fluid medium used for determining the oxidative and/or fermentative metabolism of Gram negative bacilli. This medium need to add sterile Vaseline (Art. No. 06-077-100) for anaerobic conditions.

PRESENTATION	TYPE OF PACKAGING	SPECIFICATIONS	ART. NO.	FOOD & BEVERAGES	WATER	CLINICAL	PHARMA	COSMETICS	ENVIRONMENTAL	MOLECULAR
500 g*	☐		03-037-500	●						
20 tubes with 10 ml	⏴	Ink labelled tubes and metallic cap (medium base with glucose included)	064-TA0129	●		●				
Sterile vaseline. 100 ml	☐		06-077-100	●		●				

OXIDATION-FERMENTATION GLUCOSE MEDIUM



064-TA8327
AOAC / CMPH / ISO

Fluid medium used for determining the oxidative and/or fermentative metabolism of Gram negative bacilli (*Enterobacteriaceae*) according to ISO 21528-1 and 21528-2 standards. This medium need to add sterile Vaseline (Art. No. 06-077-100) for anaerobic conditions.

PRESENTATION	TYPE OF PACKAGING	SPECIFICATIONS	ART. NO.	FOOD & BEVERAGES	WATER	CLINICAL	PHARMA	COSMETICS	ENVIRONMENTAL	MOLECULAR
20 tubes with 10 ml	⏴	Ink labelled tubes and metallic cap (medium with glucose included)	064-TA8327	●		●				
Sterile vaseline. 100 ml	☐		06-077-100	●		●				

PALCAM AGAR BASE

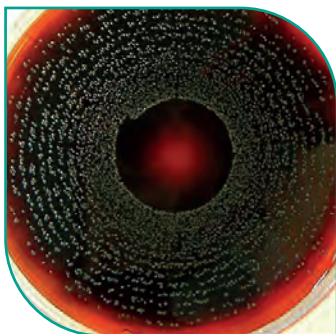

01-470
ISO

Solid, selective and differential medium for the detection, enumeration and isolation of *Listeria spp.* according to ISO 11290-1 and 11290-2 standards. Needs Palcam Agar Selective Supplement (Art. No. 06-110LYO1).

PRESENTATION	TYPE OF PACKAGING	ART. NO.	FOOD & BEVERAGES	WATER	CLINICAL	PHARMA	COSMETICS	ENVIRONMENTAL	MOLECULAR
500 g*	☐	01-470-500	●						
5x500 ml	☐	01-470BA05	●						
20 plates of 90 mm Ø	⊙	064-PA0070	●						
Palcam Selective Supplement for Listeria. 10 vials	☐	06-110LYO1	●						

PCA, see PLATE COUNT AGAR, page 94

PCA MODIFIED, see PLATE COUNT MODIFIED AGAR, page 94

PCA SKIM MILK AGAR, see PLATE COUNT SKIM MILK AGAR, page 95

PDA, see POTATO DEXTROSE AGAR, page 95

i *For dehydrated media presented in a 500 g package, we are able to offer other formats, including 5 and 25 kg. More information at: helpdesk@scharlab.com.

PDB, see POTATO DEXTROSE BROTH, page 95

PEMBA, see BACILLUS CEREUS SELECTIVE AGAR, page 40

PEPTONE WATER, see TRYPTONE WATER, page 116

PEPTONE WATER, ALKALINE



► MEDIA M10

02-468

ISO

Enrichment medium for enrichment and recovery of *Vibrio spp.* from various samples, formulated according to ISO 8914.

PRESENTATION	TYPE OF PACKAGING	SPECIFICATIONS	ART. NO.	SECTOR
10 flasks with 225 ml		Injectable cap: Plastic screw inner cap + elastomer septum + protective outer cap + shrink wrapped plastic sleeve	064-BA6065	FOOD & BEVERAGES WATER CLINICAL PHARMA COSMETICS ENVIRONMENTAL MOLECULAR

PEPTONE WATER, ALKALINE SALINE



► ASPW

02-697

COMPF / ISO / SMWW

Liquid culture medium for the pre-enrichment and selective enrichment of potentially enteropathogenic vibrios, in food samples, according to ISO/TS 21872-1 and 21872-2.

PRESENTATION	TYPE OF PACKAGING	ART. NO.	SECTOR
500 g*		02-697-500	FOOD & BEVERAGES WATER CLINICAL PHARMA COSMETICS ENVIRONMENTAL MOLECULAR

PEPTONE WATER, PHOSPHATE-BUFFERED see BUFFERED PEPTONE PHOSPHATE WATER, page 48

PEPTONE WATER, SALINE, see MAXIMUM RECOVERY DILUENT, page 82

PEPTONE WATER, SALT

02-497

Liquid medium for pre-enrichment of bacteria, in particular pathogenic members of enterobacteriaceae from food and clinical samples.

PRESENTATION	TYPE OF PACKAGING	ART. NO.	SECTOR
500 g*		02-497-500	FOOD & BEVERAGES WATER CLINICAL PHARMA COSMETICS ENVIRONMENTAL MOLECULAR



*For dehydrated media presented in a 500 g package, we are able to offer other formats, including 5 and 25 kg. More information at: helpdesk@scharlab.com.

PHENOL RED BROTH BASE

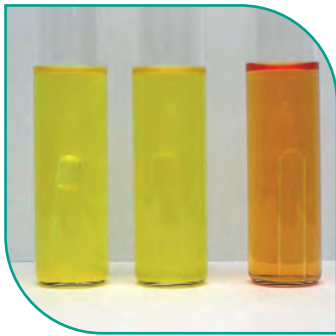

02-032

APHA / BAM / COMPF / FDA / ISO

Liquid culture medium, suitable for sugar and other substrate fermentation studies according to ISO 10273 and 22964 standards.

PRESENTATION	TYPE OF PACKAGING	ART. NO.	FOOD & BEVERAGES	WATER	CLINICAL	PHARMA	COSMETICS	ENVIRONMENTAL	MOLECULAR
500 g*	☐	02-032-500			●	●			

PHENYLALANINE AGAR (PPA)

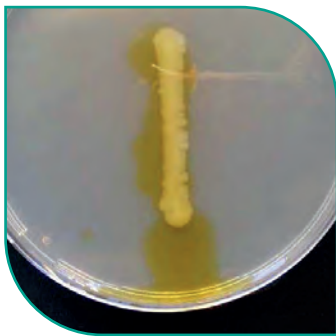

► PA MEDIUM

► PPA

01-083

CMPH

Culture medium for Enterobacteriaceae, according to Ewing et al, for detecting the ability of the *Proteus* genus to convert phenylalanine into phenilpiruvic acid. Requires the addition of 0.2 ml of a 10% solution of ferric chloride.

PRESENTATION	TYPE OF PACKAGING	SPECIFICATIONS	ART. NO.	FOOD & BEVERAGES	WATER	CLINICAL	PHARMA	COSMETICS	ENVIRONMENTAL	MOLECULAR
500 g*	☐		01-083-500			●				
5x500 ml	☐		01-083BA05			●				
20 tubes with 6.2 ml of slanted agar	⌋	Ink labelled tubes and metallic cap	064-TA0112			●				

PHOSPHATE BUFFERED SALINE (PBS) pH 7.2



Phosphate solution used in microbiological procedures.

PBS pH 7.2

PRESENTATION	TYPE OF PACKAGING	SPECIFICATIONS	ART. NO.	FOOD & BEVERAGES	WATER	CLINICAL	PHARMA	COSMETICS	ENVIRONMENTAL	MOLECULAR
10 flasks with 90 ml	☐	Injectable cap: Plastic screw inner cap + elastomer septum + protective outer cap + shrink wrapped plastic sleeve	064-BA7070			●	●			
10 flasks with 100 ml	☐	Metalic-non injectable cap	064-BA0103	●		●	●	●	●	●
10 flasks with 300 ml	☐	Injectable cap: Plastic screw inner cap + elastomer septum + protective outer cap + shrink wrapped plastic sleeve	064-BA7069			●	●			
20 tubes with 1 ml	⌋	Ink labelled tubes and metallic-non injectable cap	064-TA0103			●	●	●		●
20 tubes with 9 ml	⌋	Ink labelled tubes and metallic cap	064-TA0104			●	●	●		●

PBS pH 7.2 POLYSORBATE 5%

PRESENTATION	TYPE OF PACKAGING	SPECIFICATIONS	ART. NO.	FOOD & BEVERAGES	WATER	CLINICAL	PHARMA	COSMETICS	ENVIRONMENTAL	MOLECULAR
10 flasks with 300 ml	☐	Injectable cap: Plastic screw inner cap + elastomer septum + protective outer cap + shrink wrapped plastic sleeve	064-BA7067			●				



*For dehydrated media presented in a 500 g package, we are able to offer other formats, including 5 and 25 kg. More information at: helpdesk@scharlab.com.

PLATE COUNT AGAR (PCA)

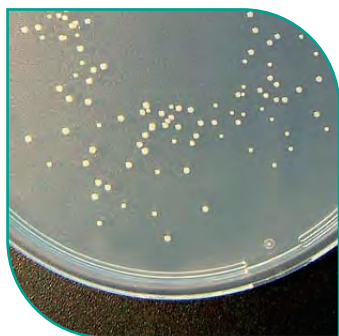

- TRIPTICASE GLUCOSE YEAST AGAR
- TGY
- TGY AGAR
- STANDARD METHODS AGAR
- SMA
- SM AGAR
- PCA

01-161

BAM / COMPF / IDF / IFU / ISO / USP

Medium for aerobic plate counts by the surface inoculation method (standard Plate Count Agar) according to ISO 4833, 8552, 17410 and IFU No. 6 standards.

➤ TLHTh (Polysorbate 80 - Lecithin - Histidine - Sodium Thiosulphate).

















PRESENTATION	TYPE OF PACKAGING	SPECIFICATIONS	ART. NO.	SECTOR						
				FOOD & BEVERAGES	WATER	CLINICAL	PHARMA	COSMETICS	ENVIRONMENTAL	MOLECULAR
500 g*			01-161-500	●	●	●	●	●	●	●
5x500 ml			01-161BA05	●	●	●	●	●	●	●
20 plates of 90 mm Ø			064-PA0024	●	●	●	●	●	●	●
20 plates of 90 mm Ø, with TTC, triple packaging			064-PA0144	●	●	●	●	●	●	●
20 plates of 90 mm Ø, irradiated, double packaging			064PA0024I	●	●	●	●	●	●	●
30 plates of 55 mm Ø			064-PF0007	●	●	●	●	●	●	●
24 contact plates triple packaging			064-PR0041	●	●	●	●	●	●	●
24 contact plates, TLHTh, triple packaging			064-PR0039	●	●	●	●	●	●	●
30 contact plates, irradiated			064-PR0001	●	●	●	●	●	●	●
30 contact plates, TLHTh, irradiated, double packaging			064-PR0020	●	●	●	●	●	●	●
80 contact plates, irradiated, triple packaging			064PRB0043	●	●	●	●	●	●	●
80 contact plates, TLHTh, irradiated, triple packaging			064PRB0044	●	●	●	●	●	●	●
10 flasks with 100 ml		Metallic-non injectable cap	064-BA1005	●	●	●	●	●	●	●
10 flasks with 200 ml		Metallic cap	064-BA3038	●	●	●	●	●	●	●
10 flasks with 450 ml		Metallic-non injectable cap	064-BA8112	●	●	●	●	●	●	●
20 tubes with 15 ml			064-TA0325	●	●	●	●	●	●	●

PLATE COUNT MODIFIED AGAR



➤ PCA MODIFIED

01-329

BAM / COMPF / IDF / IFU / ISO / USP

Modification of Plate Count Agar (Art. No. 01-161) with a lesser amount of agar, specially recommended for aerobic enumeration by the poured plate method according to ISO 4833, 8552 and 17410 standards.



PRESENTATION	TYPE OF PACKAGING	ART. NO.	SECTOR						
			FOOD & BEVERAGES	WATER	CLINICAL	PHARMA	COSMETICS	ENVIRONMENTAL	MOLECULAR
500 g*		01-329-500							●
5x500 ml		01-329BA05							●

PLATE COUNT SKIM MILK AGAR



► PCA SKIM MILK AGAR

01-412
APHA / DIN / IDF / IFU / ISO

Solid medium for the plate count of milk and dairy products, according to DIN, FIL/IDF and ISO 4833, 8552 and 17410 standards.

PRESENTATION	TYPE OF PACKAGING	SPECIFICATIONS	ART. NO.	FOOD & BEVERAGES	WATER	CLINICAL	PHARMA	COSMETICS	ENVIRONMENTAL	MOLECULAR
500 g*	☐		01-412-500	●						
5x500 ml	☐		01-412BA05	●						
10 flasks with 100 ml	☒	Metalic-non injectable cap	064-BA2120	●						
10 flasks with 200 ml	☒	Metalic-non injectable cap	064-BA3057	●						

POTATO DEXTROSE AGAR (EUR. PHARM.)

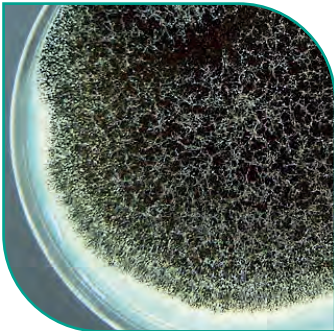

► PDA

01-483
BAM / COMPF / EP / HP / ISO / USP

Culture medium used for the detection and enumeration of fungi in food, dairy products and other samples according to the Pharmacopeial Harmonised and ISO 16212 and 18146 standards.

PRESENTATION	TYPE OF PACKAGING	SPECIFICATIONS	ART. NO.	FOOD & BEVERAGES	WATER	CLINICAL	PHARMA	COSMETICS	ENVIRONMENTAL	MOLECULAR
500 g*	☐		01-483-500	●		●	●			
5x500 ml	☐		01-483BA05	●		●	●			
20 plates of 90 mm Ø	☒		064-PA0015	●		●	●			
30 plates of 55 mm Ø	☒		064-PF6029	●		●	●			
10 flasks with 100 ml	☒	Metalic-non injectable cap	064-BA3063	●		●	●	●	●	●
10 flasks with 200 ml	☒	Metalic-non injectable cap	064-BA8032	●		●	●			

POTATO DEXTROSE BROTH

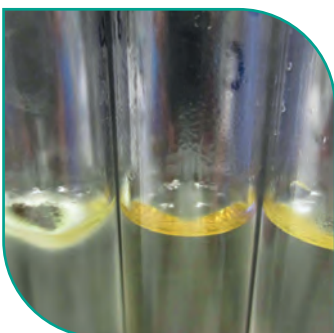

► PDB

02-483
BAM / COMPF / SMD

Liquid culture medium for the maintenance and multiplication of yeasts.

PRESENTATION	TYPE OF PACKAGING	ART. NO.	FOOD & BEVERAGES	WATER	CLINICAL	PHARMA	COSMETICS	ENVIRONMENTAL	MOLECULAR
500 g*	☐	02-483-500	●			●			
5x500 ml	☐	02-483BA05	●			●			

PRESTON *CAMPYLOBACTER* AGAR BASE



01-451

A general purpose medium-base that when appropriately supplemented can be used as a selective medium for *Campylobacter*.

PRESENTATION	TYPE OF PACKAGING	ART. NO.	FOOD & BEVERAGES	WATER	CLINICAL	PHARMA	COSMETICS	ENVIRONMENTAL	MOLECULAR
500 g*	📦	01-451-500	●						
Campylobacter Preston Selective Supplement. 10 vials	📦	06-130LY01	●						
Campylobacter Preston Modified Selective Supplement. 10 vials	📦	06-135LY01	●						

PRESTON *CAMPYLOBACTER* BROTH BASE

02-561

Liquid medium for general use, with a high concentration of nutrients.

PRESENTATION	TYPE OF PACKAGING	ART. NO.	FOOD & BEVERAGES	WATER	CLINICAL	PHARMA	COSMETICS	ENVIRONMENTAL	MOLECULAR
500 g*	📦	02-561-500	●						
Campylobacter Preston Selective Supplement. 10 vials	📦	06-130LY01	●						
Campylobacter Preston Modified Selective Supplement. 10 vials	📦	06-135LY01	●						

PSEUDOMONAS AGAR BASE (ISO)

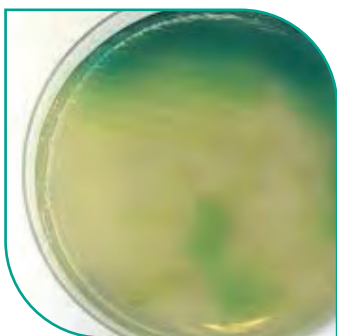

01-728

EN / ISO

Selective medium for *Pseudomonas* species when adding the Selective Supplement CFC (Art. No. 06-726LY01) according to ISO 13720 standard.

For selective medium according to the EN 12780 and ISO 16266 standard, add 2 vials of the Selective Supplement CN (Art. No. 06-742LY01).

PRESENTATION	TYPE OF PACKAGING	ART. NO.	FOOD & BEVERAGES	WATER	CLINICAL	PHARMA	COSMETICS	ENVIRONMENTAL	MOLECULAR
500 g*	📦	01-728-500	●	●					
CFC Selective Supplement. 10 vials	📦	06-726LY01		●					
CN Selective Supplement. 10 vials	📦	06-742LY01		●					

PSEUDOMONAS CFC AGAR

► CFC AGAR



01-728

EN / ISO

Selective medium for isolation of *Pseudomonas spp.* in meat and meat products according to EN 13720 and 16266 standards.

PRESENTATION	TYPE OF PACKAGING	ART. NO.	FOOD & BEVERAGES	WATER	CLINICAL	PHARMA	COSMETICS	ENVIRONMENTAL	MOLECULAR
500 g*	📦	01-728-500	●						
20 plates of 90 mm Ø	📦	064-PA6044	●		●				
CFC Selective Supplement. 10 vials	📦	06-726LY01	●						

PURPLE BROTH BASE



02-663
ISO

Broth base used for the biochemical differentiation of *Shigella* spp., based on carbohydrate fermentation according to ISO 21567 standard.

PRESENTATION	TYPE OF PACKAGING	ART. NO.	FOOD & BEVERAGES	WATER	CLINICAL	PHARMA	COSMETICS	ENVIRONMENTAL	MOLECULAR
500 g*	☐	02-663-500	●						

R2A AGAR

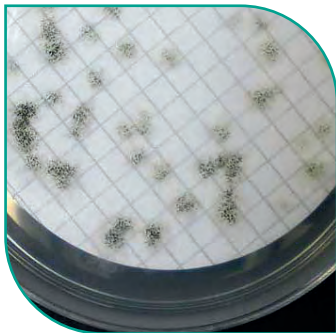

01-540
EP / HP / ISO / SMWW

Solid medium for the enumeration of heterotrophic microorganisms in treated waters according to Pharmacopoeial Harmonised Method.

PRESENTATION	TYPE OF PACKAGING	SPECIFICATIONS	ART. NO.	FOOD & BEVERAGES	WATER	CLINICAL	PHARMA	COSMETICS	ENVIRONMENTAL	MOLECULAR
500 g*	☐		01-540-500	●	●					
5x500 ml	☐		01-540BA05	●	●					
20 irradiated plates of 90 mm Ø	☉		064PA0072I	●	●					
20 irradiated plates of 90 mm Ø triple packaging	☉		064-PA0172	●	●					
30 plates of 55 mm Ø	☐		064-PF0072	●	●					
10 flasks with 100 ml	☒	Metallic-non injectable cap	064-BA0072	●	●					

RCA, see REINFORCED CLOSTRIDIAL AGAR, page 99

RCM, see REINFORCED CLOSTRIDIAL MEDIUM, page 99

RAKA RAY AGAR



01-801

Solid selective medium used for the detection and isolation of lactic acid bacteria in the beer and brewing process.

PRESENTATION	TYPE OF PACKAGING	ART. NO.	FOOD & BEVERAGES	WATER	CLINICAL	PHARMA	COSMETICS	ENVIRONMENTAL	MOLECULAR
500 g*	☐	01-801-500	●						



*For dehydrated media presented in a 500 g package, we are able to offer other formats, including 5 and 25 kg. More information at: helpdesk@scharlab.com.

RAPPAPORT VASSILIADIS BROTH





➤ RAPPAPORT VASSILIADIS R10 BROTH

➤ RVS BROTH

02-379

AOAC / BAM / COMPF / IDF / ISO

Liquid medium for the selective enrichment of *Salmonella* in foodstuffs and other samples, according to ISO 6579, 6785 and FIL-IDF standards.

PRESENTATION	TYPE OF PACKAGING	SPECIFICATIONS	ART. NO.	FOOD & BEVERAGES	WATER	CLINICAL	PHARMA	COSMETICS	ENVIRONMENTAL	MOLECULAR
500 g*			02-379-500	●		●				
5x500 ml			02-379BA05	●		●				
20 tubes with 10 ml		Ink labelled tubes and metallic-non injectable cap	064-TA0198	●	●	●				

RAPPAPORT VASSILIADIS MODIFIED SEMISOLID MEDIUM BASE





➤ MSRV

03-376

ISO

Semisolid medium used for the isolation of motile strains of *Salmonella* according to ISO 6579 standard. This medium need to add Novobiocin Selective Supplement (Art. No. 06-139LY01).

PRESENTATION	TYPE OF PACKAGING	ART. NO.	FOOD & BEVERAGES	WATER	CLINICAL	PHARMA	COSMETICS	ENVIRONMENTAL	MOLECULAR
500 g*		03-376-500	●						
5x500 ml		03-376BA05	●						
Novobiocine Selective Supplement (10 mg), 10 vials		06-139LY01	●						





RAPPAPORT VASSILIADIS SALMONELLA ENRICHMENT BROTH



02-668

EP / HP / ISO / USP

Selective liquid medium used for the enrichment of *Salmonella* according to the Pharmacopoeial Harmonised Method and ISO 6340 and USP 33- NF 28 standards.

PRESENTATION	TYPE OF PACKAGING	SPECIFICATIONS	ART. NO.	FOOD & BEVERAGES	WATER	CLINICAL	PHARMA	COSMETICS	ENVIRONMENTAL	MOLECULAR
500 g*			02-668-500		●		●			
5x500 ml			02-668BA05		●		●			
10 flasks with 90 ml in 125 ml		Metal-non injectable cap	064-BA6080		●		●			
20 tubes with 10 ml		Ink labelled tubes and metallic-non injectable cap	064-TA1198		●		●			

REINFORCED CLOSTRIDIAL AGAR



➤ RCA

01-289

Solid medium for the cultivation and enumeration of clostridia and other anaerobic bacteria.

PRESENTATION	TYPE OF PACKAGING	SPECIFICATIONS	ART. NO.	FOOD & BEVERAGES	WATER	CLINICAL	PHARMA	COSMETICS	ENVIRONMENTAL	MOLECULAR
500 g*	☐		01-289-500	●	●	●				
20 tubes with 10 ml	⏊	Ink labelled tubes and metallic cap	064-TA0201	●	●	●				

REINFORCED CLOSTRIDIAL MEDIUM (EUR. PHARM.)



➤ RCM

➤ REINFORCED MEDIUM FOR CLOSTRIDIA

➤ MEDIUM P EUR. PHARM. 5TH ED.

03-289

EP / HP / ISO / USP

Fluid medium for the cultivation and enumeration of clostridia by the MPN Technique according to the Pharmacopoeial Harmonised Method and ISO 10705-4 standard.

PRESENTATION	TYPE OF PACKAGING	SPECIFICATIONS	ART. NO.	FOOD & BEVERAGES	WATER	CLINICAL	PHARMA	COSMETICS	ENVIRONMENTAL	MOLECULAR
500 g*	☐		03-289-500	●			●			
5x500 ml	☐		03-289BA05	●			●			
10 flasks with 100 ml	⏊	Metalic-non injectable cap	064-BA3051	●			●			

REINFORCED CLOSTRIDIAL MEDIUM DIFFERENTIAL (DRCM)

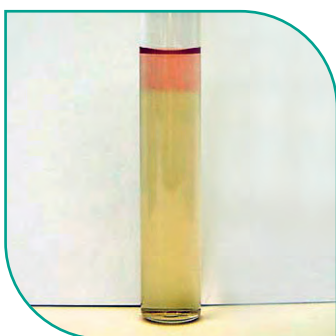

➤ DRCM

02-410

DIN / ISO

Liquid medium used for the enumeration of clostridia in food samples and other products using the MPN technique according to ISO 6461-1 standard.

PRESENTATION	TYPE OF PACKAGING	ART. NO.	FOOD & BEVERAGES	WATER	CLINICAL	PHARMA	COSMETICS	ENVIRONMENTAL	MOLECULAR
500 g*	☐	02-410-500	●	●	●				

RF-TLHC



064-BA4009

ISO

Widely used isotonic diluent in microbiology for maximum recovery of microorganisms formulated according to ISO 6887-1, 8261, 21149, 21150, 22717 and 22718, with neutralizing agents TLH (Polysorbate 80 - Lecithin - Histidine).

PRESENTATION	TYPE OF PACKAGING	SPECIFICATIONS	ART. NO.	FOOD & BEVERAGES	WATER	CLINICAL	PHARMA	COSMETICS	ENVIRONMENTAL	MOLECULAR
10 flasks with 100 ml	⏊	Metalic-non injectable cap	064-BA4009				●			



*For dehydrated media presented in a 500 g package, we are able to offer other formats, including 5 and 25 kg. More information at: helpdesk@scharlab.com.

RHAMNOSE BROTH



064-TA8315
FDA / ISO

Liquid medium to verify the utilization of rhamnose in fastidious microorganisms, such as *Listeria spp.*, according to ISO 11290.

PRESENTATION	TYPE OF PACKAGING	SPECIFICATIONS	ART. NO.	SECTOR
20 tubes with 2 ml	⌋	Ink labelled tubes, metallic-Non injectable cap	064-TA8315	FOOD & BEVERAGES WATER CLINICAL PHARMA COSMETICS ENVIRONMENTAL MOLECULAR

RINGER, POWDER



06-073

Isotonic solution for the cellular suspensions.

PRESENTATION	TYPE OF PACKAGING	SPECIFICATIONS	ART. NO.	SECTOR
500 g*	⊞		06-073-500	FOOD & BEVERAGES WATER CLINICAL PHARMA COSMETICS ENVIRONMENTAL MOLECULAR
10 flasks with 90 ml	⊞	Metalic-non injectable cap	064-BA3034	FOOD & BEVERAGES WATER CLINICAL PHARMA COSMETICS ENVIRONMENTAL MOLECULAR
6 flasks with 500 ml	⊞	Injectable cap: Plastic screw inner cap + elastomer septum	064-BA8019	FOOD & BEVERAGES WATER CLINICAL PHARMA COSMETICS ENVIRONMENTAL MOLECULAR
20 tubes with 9 ml	⌋	Ink labelled tubes and metallic cap	064-TA2159	FOOD & BEVERAGES WATER CLINICAL PHARMA COSMETICS ENVIRONMENTAL MOLECULAR
20 tubes with 10 ml	⌋	Ink labelled tubes and metallic cap	064-TA2120	FOOD & BEVERAGES WATER CLINICAL PHARMA COSMETICS ENVIRONMENTAL MOLECULAR

ROSE BENGAL CHLORAMPHENICOL AGAR



- ROSE BENGAL CHLORAMPHENICOL AGAR
- RBC AGAR

- ROSE BENGAL AGAR
- ROSE BENGAL-MALT EXTRACT AGAR

01-301

APHA / COMPF / MWW

Solid and selective medium for the isolation of yeasts and moulds from the environment and food products.

PRESENTATION	TYPE OF PACKAGING	SPECIFICATIONS	ART. NO.	SECTOR
500 g*	⊞		01-301-500	FOOD & BEVERAGES WATER CLINICAL PHARMA COSMETICS ENVIRONMENTAL MOLECULAR
5x500 ml	⊞		01-301BA05	FOOD & BEVERAGES WATER CLINICAL PHARMA COSMETICS ENVIRONMENTAL MOLECULAR
20 plates of 90 mm Ø	⊞		064-PA0038	FOOD & BEVERAGES WATER CLINICAL PHARMA COSMETICS ENVIRONMENTAL MOLECULAR
30 contact plates, irradiated, double packaging	⊞		064-PR0007	FOOD & BEVERAGES WATER CLINICAL PHARMA COSMETICS ENVIRONMENTAL MOLECULAR
80 contact plates, irradiated, triple packaging	⊞		064PRB0091	FOOD & BEVERAGES WATER CLINICAL PHARMA COSMETICS ENVIRONMENTAL MOLECULAR
10 flasks with 100 ml	⊞	Non injectable cap	064-BA1009	FOOD & BEVERAGES WATER CLINICAL PHARMA COSMETICS ENVIRONMENTAL MOLECULAR
20 tubes with 15 ml	⌋	Ink labelled tubes and metallic-non injectable cap	064-TA2146	FOOD & BEVERAGES WATER CLINICAL PHARMA COSMETICS ENVIRONMENTAL MOLECULAR



*For dehydrated media presented in a 500 g package, we are able to offer other formats, including 5 and 25 kg. More information at: helpdesk@scharlab.com.

SABOURAUD BROTH (EUR. PHARM.)



02-165 EP / HP / USP

Liquid medium for fungal isolation and sterility test according to the Pharmacopoeial Harmonised Method.

PRESENTATION	TYPE OF PACKAGING	SPECIFICATIONS	ART. NO.	SECTOR							
				FOOD & BEVERAGES	WATER	CLINICAL	PHARMA	COSMETICS	ENVIRONMENTAL	MOLECULAR	
500 g*	☐		02-165-500	●			●				
5x500 ml	☐		02-165BA05	●			●				
10 flask with 100 ml of 125 ml	☐	Injectable cap: Plastic screw inner cap + elastomer septum + protective outer cap	064-BA0100	●			●				
20 tubes with 9 ml	☐	Ink labelled tubes and metallic cap	064-TA2148	●			●				

SABOURAUD CHLORAMPHENICOL AGAR

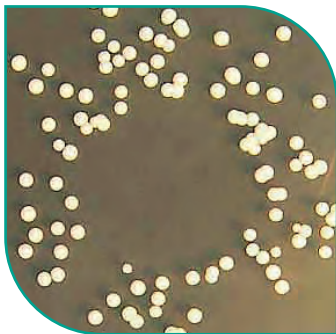

► SCA

01-166 EP / ISO

Solid culture medium for the isolation of fungi according to ISO 16212 and 18416 standards.

► TLHTh (Polysorbate 80 - Lecithin - Histidine - Sodium Thiosulphate).

PRESENTATION	TYPE OF PACKAGING	SPECIFICATIONS	ART. NO.	SECTOR						
				FOOD & BEVERAGES	WATER	CLINICAL	PHARMA	COSMETICS	ENVIRONMENTAL	MOLECULAR
500 g*	☐		01-166-500	●	●	●	●	●	●	●
5x500 ml	☐		01-166BA05	●	●	●	●	●	●	●
20 plates of 90 mm Ø	☐		064-PA0026	●	●	●	●	●	●	●
20 plates of 90 mm Ø, irradiated, double packaging	☐		064PA0026I	●	●	●	●	●	●	●
20 plates of 90 mm Ø, irradiated, triple packaging	☐		064-PA0137	●	●	●	●	●	●	●
30 plates of 55 mm Ø	☐		064-PF0022	●	●	●	●	●	●	●
30 contact plates, irradiated, double packaging	☐		064-PR0003	●	●	●	●	●	●	●
24 contact plates, irradiated, triple packaging	☐		064-PR0037	●	●	●	●	●	●	●
24 contact plates, irradiated, triple packaging	☐	Labelled RODAC plates with auto lock closure	64PR0037AL				●			
80 contact plates, irradiated, triple packaging	☐		064PRB0042	●	●	●	●	●	●	●
80 contact plates, TLHTh, irradiated, triple packaging	☐		064PRB0094	●	●	●	●	●	●	●
10 flasks with 100 ml	☐	Metalic-non injectable cap	064-BA1007	●	●	●	●		●	
10 flasks with 200 ml	☐	Metalic-non injectable cap	064-BA3039	●	●	●	●		●	
10 flasks of 475 ml	☐	Metalic-non injectable cap	BA1007-500	●	●	●	●	●	●	●
20 tubes with 6.2 ml of slanted agar	☐	Ink labelled tubes and metallic cap	064-TA0136	●	●	●	●	●	●	●
20 tubes with 15 ml	☐	Ink labelled tubes and metallic-non injectable cap	064-TA2160	●	●	●	●	●	●	●



*For dehydrated media presented in a 500 g package, we are able to offer other formats, including 5 and 25 kg. More information at: helpdesk@scharlab.com.

SABOURAUD CHLORAMPHENICOL GENTAMICIN CYCLOHEXIMIDE



064-PA6125
EP / ISO / USP

Medium for the enumeration and cultivation of pathogenic fungi (Dermatophytes) according to USP 33-NF 28.

PRESENTATION	TYPE OF PACKAGING	ART. NO.	SECTOR
20 plates of 90 mm Ø	☉	064-PA6125	FOOD & BEVERAGES WATER CLINICAL PHARMA COSMETICS ENVIRONMENTAL MOLECULAR

SABOURAUD CHLORAMPHENICOL MODIFIED AGAR

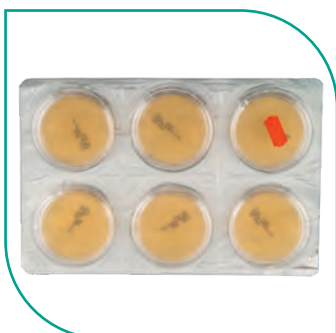

064-PR0035

Medium for the enumeration and cultivation of fungi with 0.1 g/l of chloramphenicol.

PRESENTATION	TYPE OF PACKAGING	ART. NO.	SECTOR
24 contact plates, triple packaging	☉☉☉	064-PR0035	FOOD & BEVERAGES WATER CLINICAL PHARMA COSMETICS ENVIRONMENTAL MOLECULAR

SABOURAUD CHLORAMPHENICOL PENASE AGAR



064-PA3135
EP / HP / ISO / USP

Medium for the enumeration and cultivation of fungi, according to harmonized pharmacopoeial monographs and test methods according to ISO 13681 standard.

PRESENTATION	TYPE OF PACKAGING	SPECIFICATIONS	ART. NO.	SECTOR
20 plates of 90 mm Ø	☉	1 box with 2 cellophane bags with 10 plates/bag	064-PA3135	FOOD & BEVERAGES WATER CLINICAL PHARMA COSMETICS ENVIRONMENTAL MOLECULAR



*For dehydrated media presented in a 500 g package, we are able to offer other formats, including 5 and 25 kg. More information at: helpdesk@scharlab.com.

**SABOURAUD
DEXTROSE AGAR**



➤ SDA

01-165

BAM / EP / HP / ISO / USP

Solid medium for the enumeration and cultivation of fungi according to the Pharmacopeial Harmonised Method and ISO 13681 standard. This medium need to add Chloramphenicol Selective Supplement (Art. No. 06-118-LYO1) and Oxytetracycline Selective Supplement (Art. No. 06-115LYO1).

➤ TLHth (Polysorbate 80 - Lecithin - Histidine - Sodium Thiosulphate).

PRESENTATION	TYPE OF PACKAGING	SPECIFICATIONS	ART. NO.	SECTOR						
				FOOD & BEVERAGES	WATER	CLINICAL	PHARMA	COSMETICS	ENVIRONMENTAL	MOLECULAR
500 g*	☐		01-165-500	●	●	●	●	●	●	●
5x500 ml	☐		01-165BA05	●	●	●	●	●	●	●
20 plates of 90 mm Ø	☉		064-PA0025	●	●	●	●	●	●	●
20 plates of 90 mm Ø, irradiated, double packaging	☉		064PA0025I	●	●	●	●	●	●	●
20 plates of 90 mm Ø, irradiated, triple packaging	☉		064-PA0147	●	●	●	●	●	●	●
30 plates of 55 mm Ø	☐		064-PF0006	●	●	●	●	●	●	●
30 contact plates, irradiated, double packaging	☐☐		064-PR0002	●	●	●	●	●	●	●
24 contact plates, irradiated, triple packaging	☐☐☐		064-PR0062	●	●	●	●	●	●	●
80 contact plates, irradiated, triple packaging	☐☐☐		064PRB0092	●	●	●	●	●	●	●
10 flasks with 100 ml	☐	Metalic-non injectable cap	064-BA1006	●	●	●	●	●	●	●
10 flasks with 200 ml	☐	Metalic-non injectable cap	064-BA3007	●	●	●	●	●	●	●
10 flasks with 400 ml	☐	Metalic-non injectable cap	064-BA8132	●	●	●	●	●	●	●
20 tubes with 6.2 ml of slanted agar	☐	Ink labelled tubes and metallic cap	064-TA0135	●	●	●	●	●	●	●
20 tubes with 20 ml	☐	Ink labelled tubes and Non-injectable metallic cap	064-TA8301	●	●	●	●	●	●	●
Oxytetracycline Selective Supplement. 10 vials	☐		06-115LYO1	●	●	●	●	●	●	●
Chloramphenicol Selective Supplement. 10 vials	☐		06-118LYO1	●	●		●	●	●	●

SDA + TLHth

PRESENTATION	TYPE OF PACKAGING	SPECIFICATIONS	ART. NO.	SECTOR						
				FOOD & BEVERAGES	WATER	CLINICAL	PHARMA	COSMETICS	ENVIRONMENTAL	MOLECULAR
20 irradiated plates of 90 mm Ø with TLHth	☉		064-PA0022	●	●	●	●	●	●	●
30 contact plates, TLHth, irradiated, double packaging	☐☐	Labelled RODAC plates with auto lock closure	64PR0022AL				●			
30 contact plates, TLHth, irradiated, double packaging	☐☐		064-PR0022	●	●	●	●	●	●	●
24 contact plates, TLHth, irradiated, triple packaging	☐☐☐		064-PR0042	●	●	●	●	●	●	●
24 contact plates, TLHth, irradiated, triple packaging	☐☐☐	Labelled RODAC plates with auto lock closure	64PR0042AL				●			
80 contact plates, TLHth, irradiated triple packaging	☐☐☐		064PRB0041	●	●	●	●	●	●	●



*For dehydrated media presented in a 500 g package, we are able to offer other formats, including 5 and 25 kg. More information at: helpdesk@scharlab.com.

SABOURAUD OXYTETRACYCLINE AGAR (OGYEA)

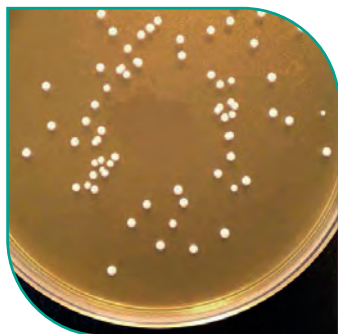

➤ OXYTETRACYCLINE-GLUCOSE-YEAST EXTRACT AGAR
➤ OGY AGAR

➤ OGYE AGAR BASE
➤ OGYEA

01-275
APHA / EP / ISO / USP

Solid culture medium for total enumeration of yeasts and moulds according to ISO 13681. This medium need to add Oxytetracycline Selective Supplement (Art. No. 06-115LY01).

PRESENTATION	TYPE OF PACKAGING	SPECIFICATIONS	ART. NO.	SECTOR							
				FOOD & BEVERAGES	WATER	CLINICAL	PHARMA	COSMETICS	ENVIRONMENTAL	MOLECULAR	
500 g*	☐		01-275-500	●			●		●		
5x500 ml	☐		01-275BA05	●			●		●		
20 plates of 90 mm Ø	☉		064-PA3124	●			●		●		
10 flasks with 100 ml	☒	Metalic-non injectable cap	064-BA2128	●			●		●		
10 flasks with 200 ml	☒	Non injectable cap	BA9992-200	●			●		●		
Oxytetracycline Selective Supplement. 10 vials	☐		06-115LY01	●			●		●		

SALINE SOLUTION



Saline solution for microbiology.

SALINE

PRESENTATION	TYPE OF PACKAGING	SPECIFICATIONS	ART. NO.	SECTOR							
				FOOD & BEVERAGES	WATER	CLINICAL	PHARMA	COSMETICS	ENVIRONMENTAL	MOLECULAR	
20 tubes with 3 ml	☒	Ink labelled tubes and metallic cap	064-TA0105	●		●	●	●	●	●	●
20 tubes with 5 ml	☒	Ink labelled tubes and metallic cap	064-TA0194	●		●	●	●	●	●	●
20 tubes with 9 ml	☒	Ink labelled tubes and metallic cap	064-TA0095	●		●	●	●	●	●	●
20 tubes with 10 ml	☒	Ink labelled tubes and metallic cap	064-TA0094	●		●	●	●	●	●	●

SALINE + 0.5% POLYSORBATE 80

PRESENTATION	TYPE OF PACKAGING	SPECIFICATIONS	ART. NO.	SECTOR							
				FOOD & BEVERAGES	WATER	CLINICAL	PHARMA	COSMETICS	ENVIRONMENTAL	MOLECULAR	
20 tubes with 9 ml	☒	Ink labelled tubes and Metallic-Non injectable cap	064-TA6017	●		●	●	●	●	●	●

SALMONELLA SHIGELLA AGAR (SS AGAR)

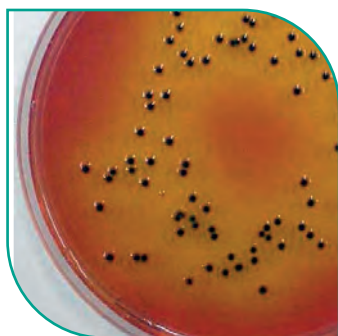

➤ SS AGAR

01-555
APHA / AOAC / COMPF

Differential and selective solid medium for the isolation of *Salmonella* and some *Shigella* species from clinical specimens, food, etc.

PRESENTATION	TYPE OF PACKAGING	ART. NO.	SECTOR							
			FOOD & BEVERAGES	WATER	CLINICAL	PHARMA	COSMETICS	ENVIRONMENTAL	MOLECULAR	
500 g*	☐	01-555-500	●		●					
5x500 ml	☐	01-555BA05	●		●					
20 plates of 90 mm Ø	☉	064-PA0028	●		●					

SCA, see SABOURAUD CHLORAMPHENICOL AGAR, page 101

 *For dehydrated media presented in a 500 g package, we are able to offer other formats, including 5 and 25 kg. More information at: helpdesk@scharlab.com.

SCHAEDLER AGAR

01-231 APHA

Solid medium with high reducing and nutrient capacity for the culture of fastidious anaerobic microorganisms.

PRESENTATION	TYPE OF PACKAGING	ART. NO.	FOOD & BEVERAGES	WATER	CLINICAL	PHARMA	COSMETICS	ENVIRONMENTAL	MOLECULAR
500 g*	☐	01-231-500	●						

SCHOLTEN'S AGAR (MODIFIED)



01-840-500 ISO

Solid culture medium used as a basal layer in the enumeration of somatic coliphages in samples of any type of water, sediment and sludge, according to ISO 10705-2 standard.

PRESENTATION	TYPE OF PACKAGING	ART. NO.	FOOD & BEVERAGES	WATER	CLINICAL	PHARMA	COSMETICS	ENVIRONMENTAL	MOLECULAR
500 g*	☐	01-840-500		●					
20 plates of 90 mm Ø	☉	064-PA6115		●					

SCHOLTEN'S BROTH (MODIFIED)

02-840-500 ISO

Liquid culture medium used as a growth medium for bacteria in the enumeration of somatic coliphages in samples of any type of water, sediment and sludge, according to ISO 10705-2.

PRESENTATION	TYPE OF PACKAGING	ART. NO.	FOOD & BEVERAGES	WATER	CLINICAL	PHARMA	COSMETICS	ENVIRONMENTAL	MOLECULAR
500 g*	☐	02-840-500		●					

SDA, see SABOURAUD DEXTROSE AGAR, page 103

SELENITE BROTH BASE

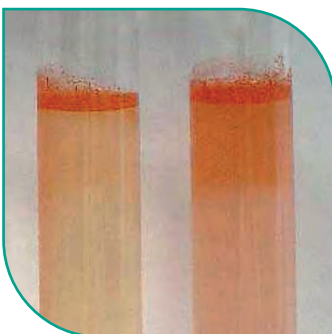

► SELENITE F BROTH

02-598 DIN / ISO

Liquid medium used for the enrichment of *Salmonella* and *Shigella* from clinical specimens and other products according to ISO 6785, 6340 standards. This medium need to add Sodium Biselenite (Art. No. SO0160). The prepared medium (Art. No. 064-TA0138) contains sodium biselenite.

PRESENTATION	TYPE OF PACKAGING	SPECIFICATIONS	ART. NO.	FOOD & BEVERAGES	WATER	CLINICAL	PHARMA	COSMETICS	ENVIRONMENTAL	MOLECULAR
500 g*	☐		02-598-500	●		●				
5x500 ml	☐		02-598BA05	●		●				
20 tubes with 10 ml	↑	Ink labelled tubes and metallic-non injectable cap	064-TA0138	●		●				
Sodium Biselenite (Additive). 100 g	☐		S001600100	●		●				



*For dehydrated media presented in a 500 g package, we are able to offer other formats, including 5 and 25 kg. More information at: helpdesk@scharlab.com.

SELENITE CYSTINE BROTH BASE



02-602

APHA / BAM / COMPF / DIN / FDA / ISO / USP

Liquid medium used for the enrichment of *Salmonella* and *Shigella* from clinical specimens and other products according to ISO 6785, 19250 standards. This medium need to add Sodium Biselenite (Art. No. SO0160). Prepared medium includes sodium selenite added.

PRESENTATION	TYPE OF PACKAGING	SPECIFICATIONS	ART. NO.	SECTOR						
				FOOD & BEVERAGES	WATER	CLINICAL	PHARMA	COSMETICS	ENVIRONMENTAL	MOLECULAR
500 g*	☐		02-602-500	●	●	●	●			
5x500 ml	☐		02-602BA05	●	●	●	●			
10 flasks with 100 ml	☐	Metalic-non injectable cap	064-BA1020	●	●	●	●			
20 tubes with 10 ml	☐	Ink labelled tubes and metalic-non injectable cap	064-TA0163	●	●	●	●			
Sodium Biselenite (Additive). 100 g	☐		SO01600100	●	●	●	●			

SHIGELLA BROTH



02-662

BAM / FDA / ISO

Liquid culture medium used for the selective enrichment of *Shigella spp.* according to ISO 21567 standard.

PRESENTATION	TYPE OF PACKAGING	ART. NO.	SECTOR						
			FOOD & BEVERAGES	WATER	CLINICAL	PHARMA	COSMETICS	ENVIRONMENTAL	MOLECULAR
500 g*	☐	02-662-500	●						
5x500 ml	☐	02-662BA05	●						

SIM MEDIUM

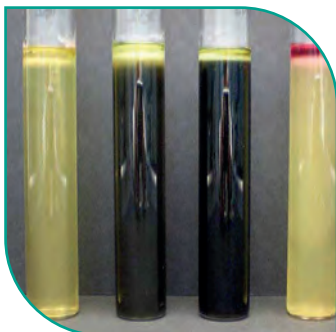

03-176

Differential medium for motility, H₂S production and indol formation.

PRESENTATION	TYPE OF PACKAGING	ART. NO.	SECTOR						
			FOOD & BEVERAGES	WATER	CLINICAL	PHARMA	COSMETICS	ENVIRONMENTAL	MOLECULAR
500 g*	☐	03-176-500	●		●				
5x500 ml	☐	03-176BA05	●		●				

SIMMONS CITRATE AGAR

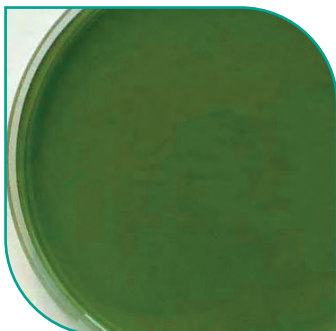

01-177

AOAC / BAM / ISO / SMWW

Solid medium for verifying the citrate utilization by enterobacteria according to ISO 10273 and 22964 standards.

PRESENTATION	TYPE OF PACKAGING	SPECIFICATIONS	ART. NO.	SECTOR						
				FOOD & BEVERAGES	WATER	CLINICAL	PHARMA	COSMETICS	ENVIRONMENTAL	MOLECULAR
500 g*	☐		01-177-500			●				
5x500 ml	☐		01-177BA05			●				
20 tubes with 6.2 ml of slanted agar	☐	Ink labelled tubes and metalic cap	064-TA0106			●				



*For dehydrated media presented in a 500 g package, we are able to offer other formats, including 5 and 25 kg. More information at: helpdesk@scharlab.com.

SLANETZ BARTLEY AGAR

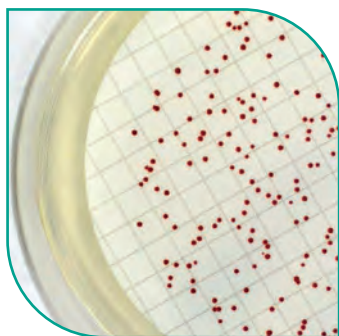

➤ M-AZIDE AGAR

➤ M-ENTEROCOCCUS AGAR

➤ M-SLANETZ ENTEROCOCCUS AGAR

01-579
ISO

Differential selective medium for the detection and enumeration of enterococci according to ISO 7899-2 standard. This medium need to add 1% TTC sterile solution (Art. No. 06-023).
The prepared medium (Art. No. 064PF6017P) not containing the additive TTC 1%.

PRESENTATION	TYPE OF PACKAGING	ART. NO.	FOOD & BEVERAGES	WATER	CLINICAL	PHARMA	COSMETICS	ENVIRONMENTAL	MOLECULAR
500 g*	☐	01-579-500	●	●					
5x500 ml	☐	01-579BA05	●	●					
20 plates of 90 mm Ø	☉	064-PA3125	●	●					
30 plates of 55 mm Ø	☐	064-PF0004	●	●					
30 plates of 55 mm Ø without TTC	☐	064PF6017P	●	●					
TTC 1% sterile solution (Additive). 100 ml	☐	06-023-100	●	●					

SMAC AGAR, see MACCONKEY SORBITOL AGAR, page 79

SORBITOL BILE BROTH



064-BA7066
ISO

Liquid medium for enrichment of *Yersinia spp.* in food samples according to ISO 10273 standard.

PRESENTATION	TYPE OF PACKAGING	SPECIFICATIONS	ART. NO.	FOOD & BEVERAGES	WATER	CLINICAL	PHARMA	COSMETICS	ENVIRONMENTAL	MOLECULAR
10 flasks with 100 ml	☐	Metalic-non injectable cap	064-BA7066	●						

SPORULATING AGAR



➤ AK 2 AGAR

➤ ARRET & KIRSHBAUM AGAR

➤ AK AGAR

➤ ANTIBIOTIC MEDIUM 32 (USP)

01-069
USP

This formulation is according to the Arret and Kirschbaum formulation, adopted by US, FDA for the preparation of spore suspension for antibiotic assay.

PRESENTATION	TYPE OF PACKAGING	ART. NO.	FOOD & BEVERAGES	WATER	CLINICAL	PHARMA	COSMETICS	ENVIRONMENTAL	MOLECULAR
500 g*	☐	01-069-500					●		

SPS AGAR, see CLOSTRIDIUM PERFRINGENS SELECTIVE AGAR, page 55

SS AGAR, see SALMONELLA SHIGELLA AGAR, page 104



*For dehydrated media presented in a 500 g package, we are able to offer other formats, including 5 and 25 kg. More information at: helpdesk@scharlab.com.

STUART RINGERTZ TRANSPORT MEDIUM



03-454

Medium used for the maintenance and transport of pathogenic specimens or fastidious microorganisms from clinical or other origin.

PRESENTATION	TYPE OF PACKAGING	ART. NO.	FOOD & BEVERAGES	WATER	CLINICAL	PHARMA	COSMETICS	ENVIRONMENTAL	MOLECULAR
500 g*	📦	03-454-500	●						

SUGAR FREE AGAR

01-264
ISO / IDF

Solid culture medium in compliance with the ISO 13559/IDF 153 standard for the enumeration of contaminating microorganisms in butter, fermented milks and fresh cheeses, by the technique of colonial count at 30°C.

PRESENTATION	TYPE OF PACKAGING	ART. NO.	FOOD & BEVERAGES	WATER	CLINICAL	PHARMA	COSMETICS	ENVIRONMENTAL	MOLECULAR
500 g*	📦	01-264-500	●						

TBA, see TRYPTONE BILE AGAR, page 115

TBX AGAR, see TRYPTONE BILE GLUCURONIC AGAR MICROINSTANT[®], page 130

TCBS AGAR

► CHOLERA MEDIUM TCBS

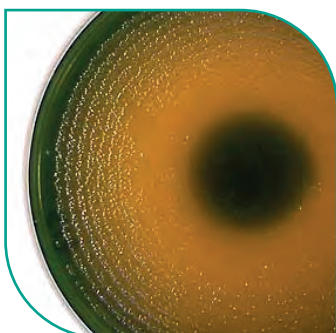

01-567

APHA / AOAC / BAM / COMPF / FDA / ISO

Solid medium for selective isolation of *Vibrio parahaemolyticus* according to ISO 8914 and 21872-2 standards.

PRESENTATION	TYPE OF PACKAGING	ART. NO.	FOOD & BEVERAGES	WATER	CLINICAL	PHARMA	COSMETICS	ENVIRONMENTAL	MOLECULAR
500 g*	📦	01-567-500	●	●	●				
5x500 ml	📦	01-567BA05	●	●	●				
20 plates of 90 mm Ø	📦	064-PA0029	●	●	●				

TERGITOL[®] 7 AGAR, see CHAPMAN TTC AGAR, page 53



*For dehydrated media presented in a 500 g package, we are able to offer other formats, including 5 and 25 kg. More information at: helpdesk@scharlab.com.

TERRIFIC BROTH



► PEPTONE WATER FOR GENETICS

02-474

Liquid medium for the cultivation of recombinant strain of *E. coli*.

PRESENTATION	TYPE OF PACKAGING	ART. NO.	SECTOR
500 g*	☐	02-474-500	FOOD & BEVERAGES WATER CLINICAL PHARMA COSMETICS ENVIRONMENTAL MOLECULAR

TGE, see TRYPTONE GLUCOSE EXTRACT AGAR, page 115

TETRATHIONATE BILE BRILLIANT GREEN BROTH BASE



02-629
EP

Liquid medium for the selective enrichment of *Salmonella* in the examination of pharmaceutical products according to the harmonized European Pharmacopoeia methods. This medium needs the addition of potassium tetrathionate.

To achieve greater selectivity is added to the medium Novobiocin Selective Supplement (Art. No. 06-139LYO1).

PRESENTATION	TYPE OF PACKAGING	ART. NO.	SECTOR
500 g*	☐	02-629-500	FOOD & BEVERAGES WATER CLINICAL PHARMA COSMETICS ENVIRONMENTAL MOLECULAR
5x500 ml	☐	02-629BA05	FOOD & BEVERAGES WATER CLINICAL PHARMA COSMETICS ENVIRONMENTAL MOLECULAR

THAYER MARTIN VCNT



064-PA0030

Selective medium for isolation *Neisseria spp.*

► **NOTE:** For the medium in dehydrated format, see **GC Agar Base**, page 64.

PRESENTATION	TYPE OF PACKAGING	ART. NO.	SECTOR
20 plates of 90 mm Ø	☉	064-PA0030	FOOD & BEVERAGES WATER CLINICAL PHARMA COSMETICS ENVIRONMENTAL MOLECULAR



*For dehydrated media presented in a 500 g package, we are able to offer other formats, including 5 and 25 kg. More information at: helpdesk@scharlab.com.

THIOGLYCOLLATE BROTH

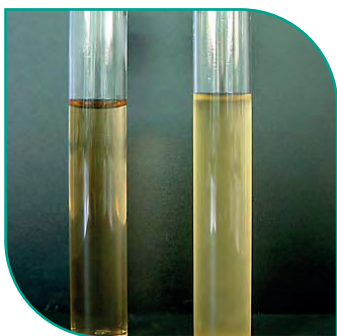

➤ USP ALTERNATIVE THIOGLYCOLATE MEDIUM

02-186

AOAC / APHA / COMPF / EP / ISO / USP

Medium used for the cultivation of anaerobic pathogenic microorganisms in clinical specimens and in sterility test of viscous or cloudy products according to ISO 7937 and USP 33-NF 28 standards.

PRESENTATION	TYPE OF PACKAGING	ART. NO.	FOOD & BEVERAGES	WATER	CLINICAL	PHARMA	COSMETICS	ENVIRONMENTAL	MOLECULAR
500 g*	☐	02-186-500			●	●			
5x500 ml	☐	02-186BA05			●	●			

THIOGLYCOLLATE FLUID MEDIUM

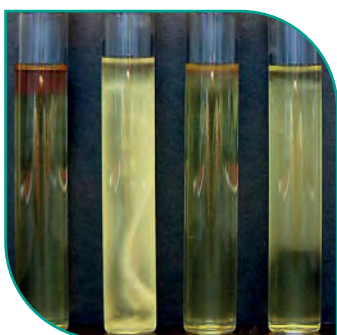

➤ FTM

➤ F THIO M

03-187

AOAC / BAM / EP / FDA / HP / USP

Fluid medium used for sterility testing according to the Eur. Pharm., USP, FDA, and for the cultivation of microaerophilic and anaerobic organisms.

PRESENTATION	TYPE OF PACKAGING	SPECIFICATIONS	ART. NO.	FOOD & BEVERAGES	WATER	CLINICAL	PHARMA	COSMETICS	ENVIRONMENTAL	MOLECULAR
500 g*	☐		03-187-500	●			●			
5x500 ml	☐		03-187BA05	●			●			
10 flasks with 40 ml	☐	Injectable cap: Plastic screw inner cap + elastomer septum + protective outer cap + shrink wrapped plastic sleeve	0BA1026-40	●			●			
10 flasks with 100 ml	☐	Injectable cap: Plastic screw inner cap + elastomer septum + protective outer cap + shrink wrapped plastic sleeve	064-BA1026	●			●			
6 flasks with 100 ml + ESTERIPAPEL®	☐	Injectable cap: Plastic screw inner cap + elastomer septum + protective outer cap	064-BA8076	●			●			
10 flasks with 450 ml	☐	Injectable cap: Plastic screw inner cap + elastomer septum + protective outer cap	064-BA1029	●			●			
20 tubes with 9 ml	☐	Ink labelled tubes and metallic cap	064-TA0134	●			●			
20 tubes with 10 ml	☐	Ink labelled tubes and metallic cap	064-TA0137	●			●			

THIOGLYCOLLATE FLUID MEDIUM PENASE



064-BA3059

AOAC / APHA / EP / FDA / USP

Fluid medium with penase used for sterility testing according to the Eur. Pharm. 9.0, USP 33-NF 28, FDA, and for the cultivation of microaerophilic and anaerobic organisms.

PRESENTATION	TYPE OF PACKAGING	SPECIFICATIONS	ART. NO.	FOOD & BEVERAGES	WATER	CLINICAL	PHARMA	COSMETICS	ENVIRONMENTAL	MOLECULAR
10 flasks with 100 ml	☐	Injectable cap: Plastic screw inner cap + elastomer septum + protective outer cap	064-BA3059				●			

TODD-HEWITT BROTH



02-191

Liquid culture medium for the propagation of β -haemolytic streptococci and for serological typing studies.

PRESENTATION	TYPE OF PACKAGING	SPECIFICATIONS	ART. NO.	SECTOR
500 g*	☐		02-191-500	●
20 tubes with 10 ml	⌋	Ink labelled tubes and metallic-non injectable cap	064-TA0157	●

FOOD & BEVERAGES
WATER
CLINICAL
PHARMA
COSMETICS
ENVIRONMENTAL
MOLECULAR

TRIBUTYRIN AGAR

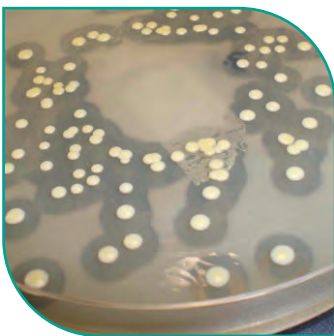

► TSB

064-BA2131

Medium for detection and enumeration of lipolytic microorganisms in food stuffs and other materials.

PRESENTATION	TYPE OF PACKAGING	SPECIFICATIONS	ART. NO.	SECTOR
10 flasks with 100 ml	☐	Metallic-non injectable cap	064-BA2131	●

FOOD & BEVERAGES
WATER
CLINICAL
PHARMA
COSMETICS
ENVIRONMENTAL
MOLECULAR

TRIPLE SUGAR IRON AGAR (TSI AGAR)



► TSI AGAR

01-192

AOAC / BAM / COMPF / DIN / EP / IDF / ISO / USP

Differential medium for identification of enterobacteria, by fermentation three sugars (lactose, sucrose and glucose) and hydrogen sulfide production ISO 6579, 6785 and 10272 standards.

PRESENTATION	TYPE OF PACKAGING	SPECIFICATIONS	ART. NO.	SECTOR
500 g*	☐		01-192-500	● ● ●
5x500 ml	☐		01-192BA05	● ● ●
20 tubes with 7.5 ml of slanted agar	⌋	Ink labelled tubes and metallic cap	064-TA0177	● ● ●

FOOD & BEVERAGES
WATER
CLINICAL
PHARMA
COSMETICS
ENVIRONMENTAL
MOLECULAR

MiStraCon®
Microbiologic Strains for Control

ATCC Licensed Derivative®

Traceability with the strains of the American Type Culture Collection (ATCC®)



Wide range of microbial strains for microbiological control. Available in 3 different formats.



TRYPTIC SOY AGAR (TSA) (EUR. PHARM.)



- CASEIN SOYBEAN DIGEST AGAR
- TSA
- MEDIUM B OF THE EUR. PHARM. 5TH ED.

01-200



















BAM / COMPF / EP / HP / ISO / USP

General purpose solid medium containing animal and plant peptone according to Pharmacopoeial Harmonised Method and ISO 9308-1, 22717 and 2296 standards.







The medium prepared Art. No.: 064-PA0100 contains defibrinated sheep blood.

- TLHTh (Polysorbate 80 - Lecithin - Histidine - Sodium Thiosulphate)

TSA (EUR. PHARM.)

PRESENTATION	TYPE OF PACKAGING	SPECIFICATIONS	ART. NO.	SECTOR
500 g*			01-200-500	FOOD & BEVERAGES, WATER, CLINICAL, PHARMA, COSMETICS, ENVIRONMENTAL, MOLECULAR
5x500 ml			01-200BA05	FOOD & BEVERAGES, WATER, CLINICAL, PHARMA, COSMETICS, ENVIRONMENTAL, MOLECULAR
20 plates of 90 mm Ø			064-PA0031	FOOD & BEVERAGES, WATER, CLINICAL, PHARMA, COSMETICS, ENVIRONMENTAL, MOLECULAR
20 plates of 90 mm		With defibrinated sheep blood	064-PA0100	FOOD & BEVERAGES, WATER, CLINICAL, PHARMA, COSMETICS, ENVIRONMENTAL, MOLECULAR
20 plates of 90 mm Ø with 30 ml medium			064-PA6071	FOOD & BEVERAGES, WATER, CLINICAL, PHARMA, COSMETICS, ENVIRONMENTAL, MOLECULAR
20 plates of 90 mm Ø, irradiated, double packaging			064PA0031I	FOOD & BEVERAGES, WATER, CLINICAL, PHARMA, COSMETICS, ENVIRONMENTAL, MOLECULAR
20 plates of 90 mm Ø, irradiated, triple packaging			064-PA0138	FOOD & BEVERAGES, WATER, CLINICAL, PHARMA, COSMETICS, ENVIRONMENTAL, MOLECULAR
30 plates of 55 mm Ø			064-PF0026	FOOD & BEVERAGES, WATER, CLINICAL, PHARMA, COSMETICS, ENVIRONMENTAL, MOLECULAR
30 contact plates, irradiated, double packaging			064-PR0004	FOOD & BEVERAGES, WATER, CLINICAL, PHARMA, COSMETICS, ENVIRONMENTAL, MOLECULAR
30 contact plates, irradiated, double packaging		Labelled RODAC plates with auto lock closure	64PR0004AL	PHARMA
24 contact plates, irradiated, triple packaging			064-PR0038	FOOD & BEVERAGES, WATER, CLINICAL, PHARMA, COSMETICS, ENVIRONMENTAL, MOLECULAR
24 contact plates, irradiated, triple packaging		Labelled RODAC plates with auto lock closure	64PR0038AL	PHARMA
80 contact plates, irradiated double packaging			064PRB0038	FOOD & BEVERAGES, WATER, CLINICAL, PHARMA, COSMETICS, ENVIRONMENTAL, MOLECULAR
10 flasks with 100 ml		Metalic-non injectable cap	064-BA1008	FOOD & BEVERAGES, WATER, CLINICAL, PHARMA, COSMETICS, ENVIRONMENTAL, MOLECULAR
10 flasks with 200 ml		Non injectable cap	064-BA6043	FOOD & BEVERAGES, WATER, CLINICAL, PHARMA, COSMETICS, ENVIRONMENTAL, MOLECULAR
10 flasks with 475 ml		Metalic-non injectable cap	BA1008-500	FOOD & BEVERAGES, WATER, CLINICAL, PHARMA, COSMETICS, ENVIRONMENTAL, MOLECULAR
20 tubes with 6.2 ml of slanted agar		Ink labelled tubes and metallic cap	064-TA0121	FOOD & BEVERAGES, WATER, CLINICAL, PHARMA, COSMETICS, ENVIRONMENTAL, MOLECULAR
20 tubes with 15 ml		Ink labelled tubes and metallic cap	064-TA0221	FOOD & BEVERAGES, WATER, CLINICAL, PHARMA, COSMETICS, ENVIRONMENTAL, MOLECULAR

TSA + TLHTh (NEUTRALISERS)

PRESENTATION	TYPE OF PACKAGING	SPECIFICATIONS	ART. NO.	SECTOR
20 plates of 90 mm Ø, TLHTh, irradiated, double packaging			064PA0075I	FOOD & BEVERAGES, WATER, CLINICAL, PHARMA, COSMETICS, ENVIRONMENTAL, MOLECULAR
20 plates of 90 mm Ø, TLHTh, irradiated, triple packaging			064-PA0139	FOOD & BEVERAGES, WATER, CLINICAL, PHARMA, COSMETICS, ENVIRONMENTAL, MOLECULAR
30 contact plates, TLHTh, irradiated, double packaging			064-PR0005	FOOD & BEVERAGES, WATER, CLINICAL, PHARMA, COSMETICS, ENVIRONMENTAL, MOLECULAR
30 contact plates, TLHTh, irradiated, double packaging		Labelled RODAC plates with auto lock closure	64PR0005AL	PHARMA
24 contact plates, TLHTh, irradiated, triple packaging			064-PR0013	FOOD & BEVERAGES, WATER, CLINICAL, PHARMA, COSMETICS, ENVIRONMENTAL, MOLECULAR
24 contact plates, TLHTh, irradiated, triple packaging		Labelled RODAC plates with auto lock closure	64PR0013AL	PHARMA
80 contact plates, irradiated triple packaging			064PRB0013	FOOD & BEVERAGES, WATER, CLINICAL, PHARMA, COSMETICS, ENVIRONMENTAL, MOLECULAR



*For dehydrated media presented in a 500 g package, we are able to offer other formats, including 5 and 25 kg. More information at: helpdesk@scharlab.com.

TSA + PENASE

PRESENTATION	TYPE OF PACKAGING	SPECIFICATIONS	ART. NO.	SECTOR
20 plates of 90 mm Ø, irradiated, triple packaging	☉	200.000 UI	064-PA0134	●
20 plates of 90 mm Ø, irradiated, triple packaging	☉	1.000.000 UI	064-PA3137	●
24 contact plates, irradiated, triple packaging	☉☉☉		064-PR0061	●
30 contact plates, irradiated, double packaging	☉☉		064-PR0028	●
80 contact plates, irradiated, triple packaging	☉☉☉		064PRB0045	●

FOOD & BEVERAGES
WATER
CLINICAL
PHARMA
COSMETICS
ENVIRONMENTAL
MOLECULAR

TSA + TLHTh (NEUTRALISERS) + β-LACTAMASE

PRESENTATION	TYPE OF PACKAGING	ART. NO.	SECTOR
20 plates of 90 mm Ø, TLHTh, irradiated, triple packaging	☉	064-PA0055	●
60 plates of 90 mm Ø, TLHTh, triple packaging	☉	064-PA6074	●
24 contact plates, TLHTh, irradiated, triple packaging	☉☉☉	064-PR0050	●

FOOD & BEVERAGES
WATER
CLINICAL
PHARMA
COSMETICS
ENVIRONMENTAL
MOLECULAR

TSA + TLHTh (NEUTRALISERS) + PENASE

PRESENTATION	TYPE OF PACKAGING	ART. NO.	SECTOR
20 plates of 90 mm Ø, TLHTh, irradiated, double packaging	☉	064-PA6006	●
20 plates of 90 mm Ø, TLHTh, irradiated, triple packaging	☉	064-PA608T	●
24 contact plates, TLHTh, irradiated, triple packaging	☉☉☉	064-PR0040	●
30 contact plates, TLHTh, irradiated, double packaging	☉☉	064-PR0027	●
80 contact plates, TLHTh, irradiated, triple packaging	☉☉☉	064PRB0040	●

FOOD & BEVERAGES
WATER
CLINICAL
PHARMA
COSMETICS
ENVIRONMENTAL
MOLECULAR

TSA + TLHTh (NEUTRALISERS) + PIRUVATE

PRESENTATION	TYPE OF PACKAGING	ART. NO.	SECTOR
20 plates of 90 mm Ø, irradiated, triple packaging	☉	064-PA6082	●
80 contact plates, irradiated, triple packaging	☉☉☉	064PRB0095	●

FOOD & BEVERAGES
WATER
CLINICAL
PHARMA
COSMETICS
ENVIRONMENTAL
MOLECULAR

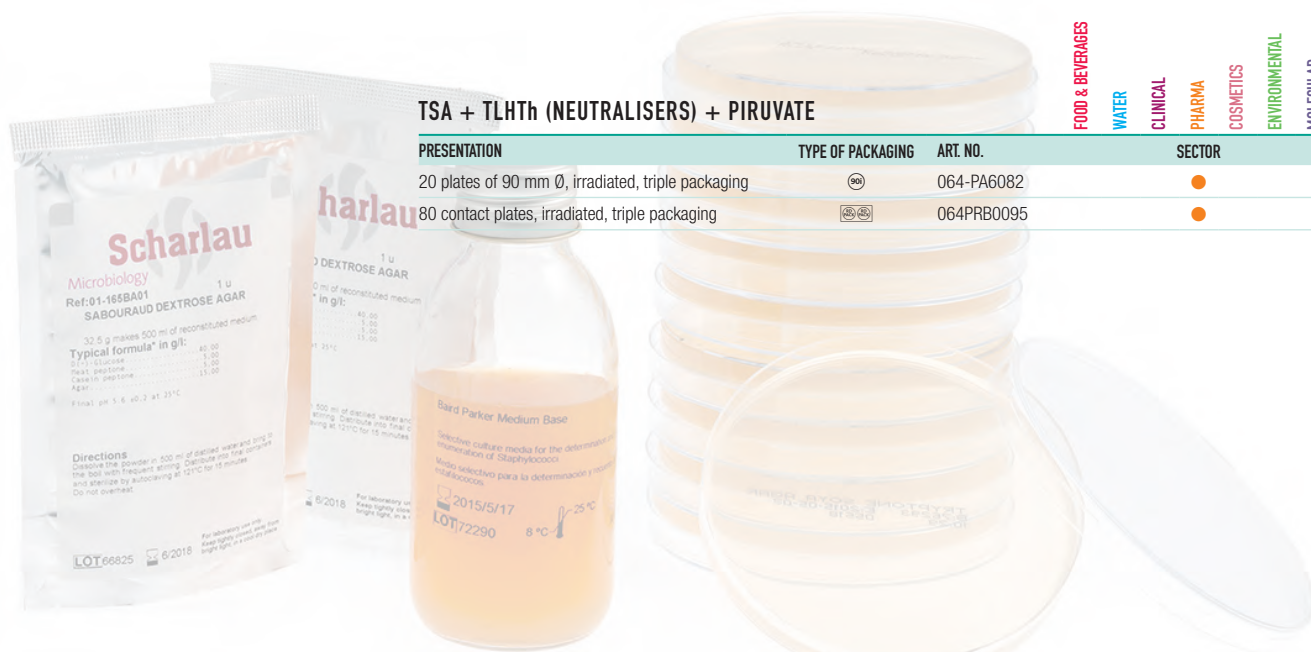

i *For dehydrated media presented in a 500 g package, we are able to offer other formats, including 5 and 25 kg. More information at: helpdesk@scharlab.com.

TRYPTIC SOY BROTH (TSB) (EUR. PHARM.)

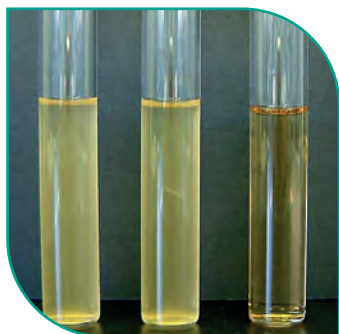

➤ CASEIN SOYA BEAN DIGEST BROTH ➤ TSB ➤ MEDIUM A ACCORDING TO EUR. PHARM. 5TH ED.

02-200

AOAC / BAM / COMPF / EP / HP / ISO / USP

Highly nutrient liquid medium for general purpose use, formulated according to Pharmacopeial Harmonised Method and ISO 9308-1 standard.

➤ **You must use connector (Art. No. 064-V70815) for bags.

TSB (EUR. PHARM.)

PRESENTATION	TYPE OF PACKAGING	SPECIFICATIONS	ART. NO.	SECTOR							
				FOOD & BEVERAGES	WATER	CLINICAL	PHARMA	COSMETICS	ENVIRONMENTAL	MOLECULAR	
500 g*	☐		02-200-500	●		●	●	●			
500 g*	☐	Irradiated	02-575-500				●				
500 g*	☐	Non animal Peptone, irradiated	02-725-500				●				
5x500 ml	☐		02-200BA05	●		●	●	●			
3 bags of 3 litres**	☐		064-BA03-3	●		●	●	●			
2 bags of 5 litres**	☐		064-BA03-5	●		●	●	●			
10 flasks with 90 ml	☐	Injectable cap: Plastic screw inner cap + elastomer septum + protective outer cap + shrink wrapped plastic sleeve	0BA1012-90	●		●	●	●			
10 flasks with 100 ml	☐	Injectable cap: Plastic screw inner cap + elastomer septum + protective outer cap + shrink wrapped plastic sleeve	064-BA1012	●		●	●	●			
6 flasks with 100 ml + 2 ESTERIPAPEL®	☐	Injectable cap: Plastic screw inner cap + elastomer septum + protective outer cap	064-BA8077	●		●	●	●			
10 flasks with 450 ml	☐	Metalic-non injectable cap	064-BA2132	●		●	●	●			
6 bottles with 800 ml	☐	Injectable cap: Plastic screw inner cap + elastomer septum + protective outer cap + shrink wrapped plastic sleeve	00BA1012-6	●		●	●	●			
20 tubes with 9 ml	☐	Ink labelled tubes and metallic cap	064-TA2147	●	●	●	●	●	●	●	
20 tubes with 10 ml	☐	Ink labelled tubes and metallic-non injectable cap	064-TA0113	●	●	●	●	●	●	●	

TSB + PENASE

PRESENTATION	TYPE OF PACKAGING	SPECIFICATIONS	ART. NO.	SECTOR							
				FOOD & BEVERAGES	WATER	CLINICAL	PHARMA	COSMETICS	ENVIRONMENTAL	MOLECULAR	
10 flasks with 100 ml	☐	Injectable cap: Plastic screw inner cap + elastomer septum + protective outer cap	064-BA3058				●				

TSB + TLHT_h (NEUTRALISERS)

PRESENTATION	TYPE OF PACKAGING	SPECIFICATIONS	ART. NO.	SECTOR							
				FOOD & BEVERAGES	WATER	CLINICAL	PHARMA	COSMETICS	ENVIRONMENTAL	MOLECULAR	
10 flasks with 100 ml	☐	Injectable cap: Plastic screw inner cap + elastomer septum + protective outer cap + shrink wrapped plastic sleeve	064-BA4006	●			●	●			

TSB + 25% CAPITOL IV

PRESENTATION	TYPE OF PACKAGING	SPECIFICATIONS	ART. NO.	SECTOR							
				FOOD & BEVERAGES	WATER	CLINICAL	PHARMA	COSMETICS	ENVIRONMENTAL	MOLECULAR	
10 flasks with 90 ml	☐	Metalic-non injectable cap	064-BA0002							●	
10 flasks with 190 ml	☐	Metalic-non injectable cap	064-BA0004							●	
6 flasks with 490 ml	☐	Metalic-non injectable cap	064-BA8008							●	

TSB + POLYSORBATE + LECITHIN

PRESENTATION	TYPE OF PACKAGING	SPECIFICATIONS	ART. NO.	SECTOR							
				FOOD & BEVERAGES	WATER	CLINICAL	PHARMA	COSMETICS	ENVIRONMENTAL	MOLECULAR	
10 flasks with 90 ml	☐	Metalic-non injectable cap	064-BA8009				●	●			



*For dehydrated media presented in a 500 g package, we are able to offer other formats, including 5 and 25 kg. More information at: helpdesk@scharlab.com.



TRYPTIC SOY BROTH MODIFIED



➤ TSBM ➤ TSB MODIFIED

02-691 BAM / DIN / FDA / ISO



Liquid culture medium used for the selective enrichment of Enterohaemorrhagic *Escherichia coli* (EHEC) in food, according to the ISO 16654 standard.

PRESENTATION	TYPE OF PACKAGING	ART. NO.	FOOD & BEVERAGES	WATER	CLINICAL	PHARMA	COSMETICS	ENVIRONMENTAL	MOLECULAR
500 g*		02-691-500	●		●				
Novobiocine Selective Supplement (10 mg). 10 vials		06-139LY01	●						

TRYPTIC SOY BROTH WITHOUT DEXTROSE

02-227 AOAC / BAM

Liquid culture medium used for the production of spores of *Geobacillus stearothermophilus* for the inhibitory substances test in food according to FDA-BAM standards.

PRESENTATION	TYPE OF PACKAGING	ART. NO.	FOOD & BEVERAGES	WATER	CLINICAL	PHARMA	COSMETICS	ENVIRONMENTAL	MOLECULAR
500 g*		02-227-500	●	●					
5x500 ml		02-227BA05	●	●					



TRYPTONE BILE AGAR



➤ TBA

01-526 ISO

Selective solid medium for the rapid enumeration of *Escherichia coli* in meat products and in water according to ISO standards 6391 and 9308-1.

PRESENTATION	TYPE OF PACKAGING	ART. NO.	FOOD & BEVERAGES	WATER	CLINICAL	PHARMA	COSMETICS	ENVIRONMENTAL	MOLECULAR
500 g*		01-526-500		●					
5x500 ml		01-526BA05		●					
30 plates of 55 mm Ø		064-PF0014		●					

TRYPTONE GLUCOSE EXTRACT AGAR (TGE AGAR)



➤ COLONY COUNT AGAR ➤ TRYPTICASE GLUCOSE EXTRACT AGAR ➤ TGE AGAR

01-082 AOAC / APHA / BAM / COMPF / FDA / ISO / SMD / SMWW

Plate count medium for milk and dairy products, according to the standard Methods for Dairy Products.

PRESENTATION	TYPE OF PACKAGING	ART. NO.	FOOD & BEVERAGES	WATER	CLINICAL	PHARMA	COSMETICS	ENVIRONMENTAL	MOLECULAR
500 g*		01-082-500	●	●					

m-TGE

064-CT0002

Liquid medium for enumeration of total bacteria by Membrane Filtration Methods.

FOOD & BEVERAGES
WATER
CLINICAL
PHARMA
COSMETICS
ENVIRONMENTAL
MOLECULAR

PRESENTATION	TYPE OF PACKAGING	ART. NO.	SECTOR						
50 vials of 2 ml		064-CT0002	●	●					

TRYPTONE SULFITE NEOMYCIN AGAR (TSN AGAR)



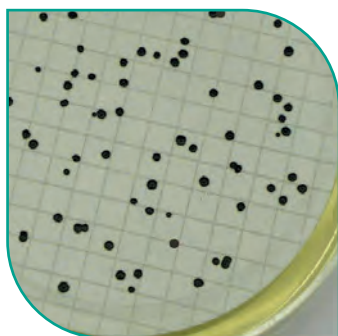

► TSN AGAR

01-195

Solid selective medium for *Clostridium perfringens* isolation.



FOOD & BEVERAGES
WATER
CLINICAL
PHARMA
COSMETICS
ENVIRONMENTAL
MOLECULAR

PRESENTATION	TYPE OF PACKAGING	SPECIFICATIONS	ART. NO.	SECTOR						
500 g*			01-195-500	●	●					
5x500 ml			01-195BA05	●	●					
20 plates of 90 mm Ø		1 box with 2 RD-PACK with 10 plates 90 mm Ø /pack. Film wrapping	064-PA6139	●	●					
20 tubes of 9 ml			064-TA2156	●	●					

TRYPTONE WATER

► PEPTONE WATER

03-156







COMPF / ISO / SMWW

Substrate with low nutrient capacity, for the detection of indol production in coliform microorganisms according to ISO 7251 standard.



► TLHTh (Polysorbate 80 - Lecithin - Histidine - Sodium Thiosulphate)

FOOD & BEVERAGES
WATER
CLINICAL
PHARMA
COSMETICS
ENVIRONMENTAL
MOLECULAR

PRESENTATION	TYPE OF PACKAGING	SPECIFICATIONS	ART. NO.	SECTOR						
500 g*			03-156-500	●						
5x500 ml			03-156BA05	●						
10 flasks with 100 ml injectables		Injectable cap: Plastic screw inner cap + elastomer septum + protective outer cap + shrink wrapped plastic sleeve	064-BA1023	●						
10 flasks with 100 ml		Metalic-non injectable cap	064-BA2126	●						
20 tubes with 9 ml		Ink labelled tubes and metallic cap	064-TA0847	●						
20 tubes of 9 ml with TLHTh		Ink labelled tubes and metallic cap	064-TA2155	●						
20 tubes with 10 ml		Ink labelled tubes and metallic cap	064-TA0120	●						



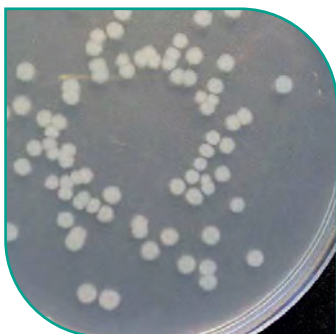



TRYPTONE YEAST EXTRACT AGAR



► WATER PLATE COUNT AGAR

01-590
ISO

Solid medium for the enumeration of water microorganisms according to ISO 6222, 5667-2, 5667-3, 6887 and 8199 standards.



PRESENTATION	TYPE OF PACKAGING	SPECIFICATIONS	ART. NO.	SECTOR						
				FOOD & BEVERAGES	WATER	CLINICAL	PHARMA	COSMETICS	ENVIRONMENTAL	MOLECULAR
500 g*			01-590-500		●					
5x500 ml			01-590BA05		●					
30 plates of 55 mm Ø			064-PF0013		●					
10 flasks with 100 ml		Metalic-non injectable cap	064-BA0013		●					
10 flasks with 200 ml		Metalic-non injectable cap	064-BA2035		●					
10 flasks with 450 ml		Metalic-non injectable cap	064-BA8117		●					
20 tubes with 15 ml		Ink labelled tubes and metalic-non injectable cap	064-TA0013		●					

TRYPTOPHAN BROTH



02-418
DIN / ISO

Liquid medium used for the detection of indol production according to ISO 9308, 6785 and 21567 standards.

PRESENTATION	TYPE OF PACKAGING	SPECIFICATIONS	ART. NO.	SECTOR						
				FOOD & BEVERAGES	WATER	CLINICAL	PHARMA	COSMETICS	ENVIRONMENTAL	MOLECULAR
500 g*			02-418-500		●					
20 tubes with 9 ml		Ink labelled tubes and metalic-non injectable cap	064-TA0115		●					



TRYPTOSE LAURYL SULFATE BROTH



► LST

02-108
APHA / BAM / COMPF / FDA / IDF / ISO / SMD / SMWW

Liquid medium used for the detection and enumeration of coliform bacteria according to IDF-FIL 73B and ISO 4831 and 7251 standards.

PRESENTATION	TYPE OF PACKAGING	SPECIFICATIONS	ART. NO.	SECTOR						
				FOOD & BEVERAGES	WATER	CLINICAL	PHARMA	COSMETICS	ENVIRONMENTAL	MOLECULAR
500 g*			02-108-500	●	●	●				
5x500 ml			02-108BA05	●	●	●				
20 tubes with 9 ml		Ink labelled tubes with Durham tubes and metallic cap	064-TA0451	●	●	●				



*For dehydrated media presented in a 500 g package, we are able to offer other formats, including 5 and 25 kg. More information at: helpdesk@scharlab.com.

TRYPTOSE LAURYL SULFATE MANNITOL TRYPTOPHAN BROTH

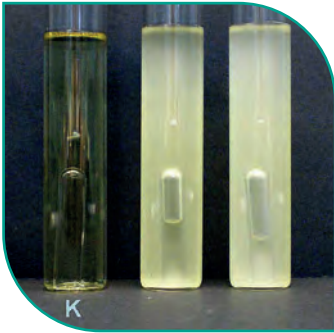

02-460
ISO

Liquid medium used for the production of indol and gas in a single tube, according to ISO 9308-1 and 9308-2 standards.

PRESENTATION	TYPE OF PACKAGING	ART. NO.	SECTOR
500 g*	☐	02-460-500	●
20 tubes of 10 ml	⌋	064-TA0452	●

FOOD & BEVERAGES
WATER
CLINICAL
PHARMA
COSMETICS
ENVIRONMENTAL
MOLECULAR

TRYPTOSE LAURYL SULFATE MODIFIED BASE BROTH (MLST)



➤ LST
➤ MLST

02-711
ISO

Liquid medium for the selective enrichment of *Cronobacter sakazakii* in milk samples and dairy products, according to the ISO 22964. Needs Vancomycin Selective Supplement (Art. No. 06-712-LY01). The prepared media (Art. No. 064-TA 0196) include Vancomycin.

PRESENTATION	TYPE OF PACKAGING	SPECIFICATIONS	ART. NO.	SECTOR
500 g*	☐		02-711-500	●
20 tubes with 10 ml	⌋	Ink labelled tubes and metallic cap	064-TA0196	● ●
Vancomycin Selective Supplement 5g, 10 vials	☐		06-712LY01	●

FOOD & BEVERAGES
WATER
CLINICAL
PHARMA
COSMETICS
ENVIRONMENTAL
MOLECULAR

CULTURE MEDIA IN TUBES



Do you know the Scharlau solid and liquid culture media in tubes?

- Shelf life of 12 months



TRYPTOSE SULFITE CYCLOSERINE AGAR (TSC AGAR)

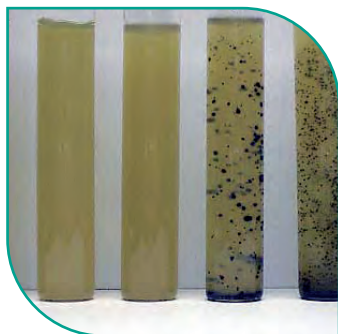

➤ TSC AGAR

01-278

AOAC / BAM / COMPF / DIN / ISO











Selective solid and differential medium for isolation and presumptive identification of *Clostridium perfringens* according to ISO 6461-2, 7937 and 14189 standards and other regulations.

This medium requires supplement:

- D-Cycloserine Selective Supplement (Art. No. 06-116LYO1): 1 vial to supplement 250 ml of medium or
- D-Cycloserine Selective Supplement (Art. No. 06-743LYO1): 1 vial to supplement 100 ml of medium.

If you want you can add supplements:

- Egg yolk sterile (Art. No. 06-016): 80 ml solution per litre of medium.
- Supplement Fluorogenic MUP (Art. No. 06-744LYO1): identification of *Clostridium perfringens*.

PRESENTATION	TYPE OF PACKAGING	SPECIFICATIONS	ART. NO.	SECTOR						
				FOOD & BEVERAGES	WATER	CLINICAL	PHARMA	COSMETICS	ENVIRONMENTAL	MOLECULAR
500 g*			01-278-500	●	●					
5x500 ml			01-278BA05	●	●					
30 plates of 55 mm Ø			064-PF0018	●	●					
30 plates of 55 mm Ø		TSC+ MUP	064-PF6024			●				
10 flasks of 100 ml (medium w/o supplement)			064-BA6016	●	●					
10 flasks of 250 ml (medium w/o supplement)		200 ml of media	064-BA8070	●	●					
D-Cycloserine Selective Supplement (100 mg). 10 vials		1 vial to supplement 225 ml of broth	06-116LYO1	●	●					
D-Cycloserine Selective Supplement. 10 vials.		1 vial to supplement 100 ml of broth	06-743LYO1	●	●					
D-Cycloserine Selective Supplement (200 mg). 10 vials		1 vial to supplement 500 ml of broth	06-794LYO1	●	●					
Supplement Fluorogenic MUP. 10 vials.		1 vial to supplement 200 ml of broth	06-744LYO1		●					
Egg yolk sterile solution. 100 ml			06-016-100	●						

TSA, see TRYPTIC SOY AGAR, page 112

TSB, see TRYPTIC SOY BROTH, page 114

TSB MODIFIED, see TRYPTIC SOY BROTH MODIFIED, page 115

TSC, see TRYPTOSE SULFITE CYCLOSERINE AGAR at the top of the page

TSI, see TRIPLE SUGAR IRON AGAR, page 111

TSN, see TRYPTONE SULFITE NEOMYCIN AGAR, page 116

TYEA, see TRYPTONE YEAST EXTRACT AGAR, page 117



*For dehydrated media presented in a 500 g package, we are able to offer other formats, including 5 and 25 kg. More information at: helpdesk@scharlab.com.

UNIVERSAL BEER AGAR (UBA)



► UBA

01-781

Base medium, to which beer may be added for the cultivation of microbial contaminants in the brewing industry.

PRESENTATION	TYPE OF PACKAGING	ART. NO.	FOOD & BEVERAGES	WATER	CLINICAL	PHARMA	COSMETICS	ENVIRONMENTAL	MOLECULAR
500 g*	☐	01-781-500	●						

UREA AGAR BASE

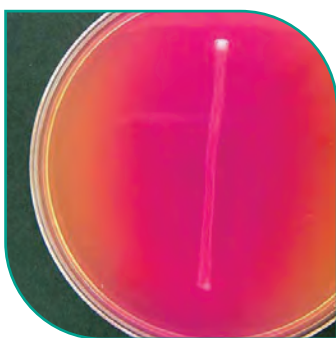

► CHRISTENSEN AGAR

01-261

APHA / COMPF / DIN / IDF / ISO / SMD

Solid medium for the detection of urease, according to ISO 6340, 6579, 6785 and 21567 standards and DIN 10160 standard. This medium requires add Urea Sterile Solution 40% (Art. No. 06-083).

PRESENTATION	TYPE OF PACKAGING	SPECIFICATIONS	ART. NO.	FOOD & BEVERAGES	WATER	CLINICAL	PHARMA	COSMETICS	ENVIRONMENTAL	MOLECULAR
500 g*	☐		01-261-500	●		●				
5x500 ml	☐		01-261BA05	●		●				
20 tubes with 6.2 ml of slanted agar	☒	Ink labelled tubes and metallic cap	064-TA0148	●		●				
Urea 40% Sterile Solution (additive). 100 ml	☐		06-083-100	●		●				

UREA BROTH BASE



02-202

AOAC / APHA / BAM / COMPF

Differential liquid medium for urease detection according to the Rustigian and Stuart formulation.

This medium requires add Urea Sterile Solution 40% (Art. No. 06-083).

Prepared medium (Art. No. 064-TA01044) contains Urea.

PRESENTATION	TYPE OF PACKAGING	SPECIFICATIONS	ART. NO.	FOOD & BEVERAGES	WATER	CLINICAL	PHARMA	COSMETICS	ENVIRONMENTAL	MOLECULAR
500 g*	☐		02-202-500			●				
5x500 ml	☐		02-202BA05			●				
20 tubes with 2 ml	☒	Ink labelled tubes and metallic-non injectable cap	064-TA0144			●				
Urea 40% Sterile Solution (additive). 100 ml	☐		06-083-100	●		●				

UVM (LISTERIA ENRICHMENT BROTH BASE), see LISTERIA ENRICHMENT BROTH BASE (UVM), page 76



*For dehydrated media presented in a 500 g package, we are able to offer other formats, including 5 and 25 kg. More information at: helpdesk@scharlab.com.

VIOLET RED BILE DEXTROSE AGAR (VRBD AGAR) (EUR. PHARM.)

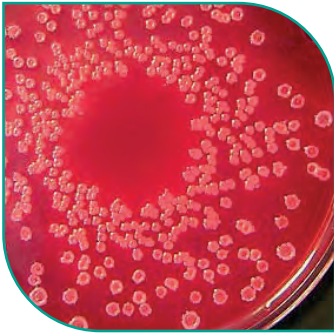

➤ MACCONKEY DEXTROSE AGAR

➤ VRBG AGAR

➤ VRBD AGAR

01-295
EP / HP / ISO / USP

Selective solid medium for the enumeration of enterobacteria, according to ISO 21528 standard and Pharmacopeial Harmonised Methods.

➤ TLHTh (Polysorbate 80 - Lecithin - Histidine - Sodium Thiosulphate)

PRESENTATION	TYPE OF PACKAGING	SPECIFICATIONS	ART. NO.	SECTOR							
				FOOD & BEVERAGES	WATER	CLINICAL	PHARMA	COSMETICS	ENVIRONMENTAL	MOLECULAR	
500 g*	☐		01-295-500	●			●				
5x500 ml	☐		01-295BA05	●			●				
20 plates of 90 mm Ø	☉		064-PA0046	●			●				
30 contact plates	☐☐☐		064-PR0006	●			●				
30 contact plates, TLHTh	☐☐☐		064-PR0044	●			●				
80 contact plates, double packaging	☐☐☐☐		064PRB0093	●			●				
10 flasks with 100 ml	☒	Metalic-non injectable cap	064-BA1011	●		●	●	●			
10 flasks with 200 ml	☒	Metalic-non injectable cap	064-BA3061	●		●	●	●			
20 tubes with 15 ml	☒	Ink labelled tubes and metalic-non injectable cap	064-TA0147	●			●				

VIOLET RED BILE LACTOSE AGAR (VRBL AGAR)

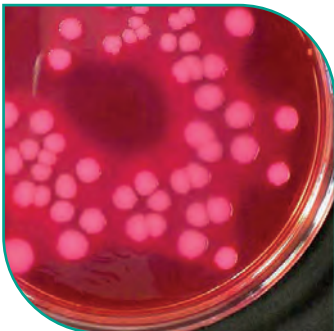

➤ VRB AGAR

➤ VRBA

➤ VRBL

01-164
APHA / COMPF / IDF-FIL / ISO

Medium for the detection and enumeration of coliforms in milk and other dairy products, according to APHA and ICMSF, FIL-IDF 73B and ISO 4832 and 5541-1 standards.

PRESENTATION	TYPE OF PACKAGING	SPECIFICATIONS	ART. NO.	SECTOR							
				FOOD & BEVERAGES	WATER	CLINICAL	PHARMA	COSMETICS	ENVIRONMENTAL	MOLECULAR	
500 g*	☐		01-164-500	●	●					●	
5x500 ml	☐		01-164BA05	●	●					●	
20 plates of 90 mm Ø	☉		064-PA0049	●	●					●	
30 contact plates	☐☐☐		064-PR0018	●	●					●	
10 flasks with 100 ml	☒	Injectable plastic screw cap	064-BA0485	●	●					●	
10 flasks with 200 ml	☒	Injectable plastic screw cap	064-BAG041	●	●					●	
20 tubes with 15 ml	☒	Ink labelled tubes and metalic cap	064-TA0485	●	●					●	

VIOLET RED BILE LACTOSE DEXTROSE AGAR



➤ VRBLD AGAR

➤ VRBLDA MEDIUM

➤ EUR PHARM. AGAR MEDIUM F

➤ MEDIUM OF THE EUR. PHARM. 5TH ED.

01-220
EP

Solid selective medium for the detection of Enterobacteriaceae according to the European Pharmacopoeia.

PRESENTATION	TYPE OF PACKAGING	ART. NO.	SECTOR							
			FOOD & BEVERAGES	WATER	CLINICAL	PHARMA	COSMETICS	ENVIRONMENTAL	MOLECULAR	
500 g*	☐	01-220-500	●	●		●	●			
MUG Fluorescent Supplement	☐	06-102LY01	●	●		●	●			

*For dehydrated media presented in a 500 g package, we are able to offer other formats, including 5 and 25 kg. More information at: helpdesk@scharlab.com.

VOGEL JOHNSON AGAR (VJ AGAR)



➤ VJ AGAR

➤ TELLURITE-GLYCINE-PHENOL RED AGAR BASE

01-206

AOAC / BAM / ISO / USP

Solid and selective medium for isolation and identification of staphylococci according to ISO 22718 standard. This medium requires add:

- 20 ml of Potassium Tellurite Solution 1% (Art. No. 06-089) or
- 6.0 ml of Potassium Tellurite Solution 3.5% (Art. No. 06-011).

PRESENTATION	TYPE OF PACKAGING	ART. NO.	FOOD & BEVERAGES	WATER	CLINICAL	PHARMA	COSMETICS	ENVIRONMENTAL	MOLECULAR
500 g*	📦	01-206-500	●	●	●	●	●		
5x500 ml	📦	01-206BA05	●	●	●	●	●		
Potassium Tellurite 3.5% Sterile Solution (Additive). 100 ml	📦	06-011-100	●		●	●	●		
Potassium Tellurite 1% Sterile Solution (Additive). 100 ml	📦	06-089-100	●						

VRBA, see VIOLET RED BILE AGAR, page 121

VRBD, see VIOLET RED BILE DEXTROSE AGAR, page 121

WATER PEPTONE, SALT, see PEPTONE WATER, SALT, page 92

WL NUTRIENT AGAR

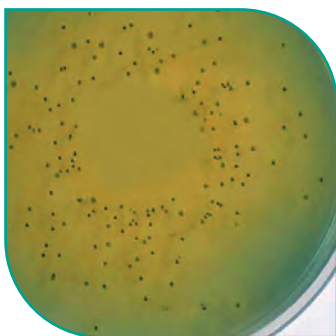

01-210

Solid medium for the culture and enumeration of yeast and bacteria for microbiological control in brewing and other fermentation industries.

PRESENTATION	TYPE OF PACKAGING	ART. NO.	FOOD & BEVERAGES	WATER	CLINICAL	PHARMA	COSMETICS	ENVIRONMENTAL	MOLECULAR
500 g*	📦	01-210-500	●						
30 plates of 55 mm Ø	📦	064-PF6019	●						
Cycloheximide Selective Supplement. 10 vials.	📦	06-022LY01	●						

WL NUTRIENT BROTH

064-CT0005

Liquid medium for the culture and enumeration of yeast and bacteria for microbiological control in brewing and other fermentation industries by MF method.

PRESENTATION	TYPE OF PACKAGING	SPECIFICATIONS	ART. NO.	FOOD & BEVERAGES	WATER	CLINICAL	PHARMA	COSMETICS	ENVIRONMENTAL	MOLECULAR
50 vials with 2 ml	📦	Tubes non-toxic polypropylene	064-CT0005	●	●	●	●	●	●	●



*For dehydrated media presented in a 500 g package, we are able to offer other formats, including 5 and 25 kg. More information at: helpdesk@scharlab.com.

WORT AGAR

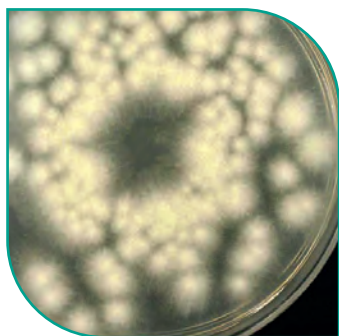

01-132

General solid medium for the cultivation of fungi.

PRESENTATION	TYPE OF PACKAGING	ART. NO.	FOOD & BEVERAGES	WATER	CLINICAL	PHARMA	COSMETICS	ENVIRONMENTAL	MOLECULAR
500 g*	☐	01-132-500	●						
20 plates of 90 mm Ø with TLH	⊙	064-PA0063	●						
30 plates of 55 mm Ø	☐	064-PF0063	●						

WORT BROTH

02-132

Liquid medium for the production of yeast suspensions.

PRESENTATION	TYPE OF PACKAGING	ART. NO.	FOOD & BEVERAGES	WATER	CLINICAL	PHARMA	COSMETICS	ENVIRONMENTAL	MOLECULAR
500 g*	☐	02-132-500	●						

XLD AGAR (EUR. PHARM.), see XYLOSE LYSINE DEOXYCHOLATE AGAR (EUR. PHARM.), page 124

XLD AGAR (ISO), see XYLOSE LYSINE DEOXYCHOLATE MODIFIED AGAR, page 124

XLT4 AGAR BASE

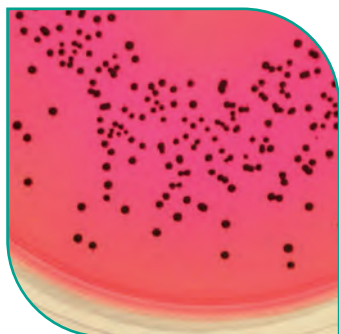

01-708

Solid culture medium for the selective and differential isolation of *Salmonella* spp. (except *S. typhi* and *S. paratyphi*).

PRESENTATION	TYPE OF PACKAGING	ART. NO.	FOOD & BEVERAGES	WATER	CLINICAL	PHARMA	COSMETICS	ENVIRONMENTAL	MOLECULAR
500 g*	☐	01-708-500	●						
20 plates of 90 mm Ø	⊙	064-PA0003	●						

XYLOSE FERMENTATION BROTH



064-TA8316
FDA / ISO

Liquid medium to verify the utilization of xylose in fastidious microorganisms, such as *Listeria* spp., according to ISO 11290.

PRESENTATION	TYPE OF PACKAGING	SPECIFICATIONS	ART. NO.	FOOD & BEVERAGES	WATER	CLINICAL	PHARMA	COSMETICS	ENVIRONMENTAL	MOLECULAR
20 tubes with 2 ml	☐	Ink labelled tubes with Durham tubes and metallic-non injectable cap	064-TA8316	●						



*For dehydrated media presented in a 500 g package, we are able to offer other formats, including 5 and 25 kg. More information at: helpdesk@scharlab.com.

XYLOSE LYSINE DEOXYCHOLATE AGAR (XLD AGAR) (EUR. PHARM.)



➤ XLD AGAR

01-211

AOAC / BAM / COMPF / EP / HP / ISO / USP

Solid culture medium for the isolation of enteropathogenic species, specially *Salmonella* and *Shigella* according to Pharmacopoeia Harmonised method and ISO 6340 standards.

PRESENTATION	TYPE OF PACKAGING	ART. NO.	SECTOR					
			FOOD & BEVERAGES	WATER	CLINICAL	PHARMA	COSMETICS	ENVIRONMENTAL
500 g*	☐	01-211-500	●	●	●			
5x500 ml	☐	01-211BA05	●	●	●			
20 plates of 90 mm Ø	☉	064-PA0034	●	●	●			

XYLOSE LYSINE DEOXYCHOLATE MODIFIED AGAR



01-552

AOAC / APHA / BAM / COMPF / ISO

Medium for isolation of enteropathogenic species, especially *Shigella* and *Salmonella* in food and animal feeding stuffs, according to ISO 6579 and 21567 standards.

PRESENTATION	TYPE OF PACKAGING	ART. NO.	SECTOR					
			FOOD & BEVERAGES	WATER	CLINICAL	PHARMA	COSMETICS	ENVIRONMENTAL
500 g*	☐	01-552-500	●		●			
5x500 ml	☐	01-552BA05	●		●			
20 plates of 90 mm Ø	☉	064-PA1035	●	●	●			

YEAST EXTRACT PEPTONE DEXTROSE BROTH (YEPD BROTH)



➤ YEPD BROTH

02-473

Liquid medium for the cultivation of yeast in molecular biology procedures.

PRESENTATION	TYPE OF PACKAGING	ART. NO.	SECTOR					
			FOOD & BEVERAGES	WATER	CLINICAL	PHARMA	COSMETICS	ENVIRONMENTAL
500 g*	☐	02-473-500						●



*For dehydrated media presented in a 500 g package, we are able to offer other formats, including 5 and 25 kg. More information at: helpdesk@scharlab.com.

YEAST MALT AGAR (YM AGAR)



➤ YMA ➤ YM AGAR ➤ YEAST & MALT EXTRACT AGAR

01-219

Solid medium for the cultivation of fungi and aciduric microorganisms.

PRESENTATION	TYPE OF PACKAGING	ART. NO.	FOOD & BEVERAGES	WATER	CLINICAL	PHARMA	COSMETICS	ENVIRONMENTAL	MOLECULAR
500 g*	☐	01-219-500	●				●		

YEAST MALT BROTH



➤ YM BROTH ➤ YEAST & MALT EXTRACT BROTH

02-219

Liquid medium for the cultivation of fungi and aciduric microorganisms.

PRESENTATION	TYPE OF PACKAGING	ART. NO.	FOOD & BEVERAGES	WATER	CLINICAL	PHARMA	COSMETICS	ENVIRONMENTAL	MOLECULAR
500 g*	☐	02-219-500	●				●		

YEAST STARCH GLUCOSE AGAR



➤ YSG AGAR

01-673

IFU

Solid medium for the detection and isolation of *Alicyclobacillus*, in fruit juices and other acidic food, according to IFU standard method No. 12.

- After autoclaving adjust the pH to 3, 7 ±0.2 by adding 1N HCl.

PRESENTATION	TYPE OF PACKAGING	ART. NO.	FOOD & BEVERAGES	WATER	CLINICAL	PHARMA	COSMETICS	ENVIRONMENTAL	MOLECULAR
500 g*	☐	01-673-500	●						
5x500 ml	☐	01-673BA05	●						
20 tubes of 20 ml	⌋	064-TA8302	●						



*For dehydrated media presented in a 500 g package, we are able to offer other formats, including 5 and 25 kg. More information at: helpdesk@scharlab.com.

YEAST STARCH GLUCOSE BROTH (YSG)



➤ YSG BROTH

02-673
IFU

Liquid medium used for the detection and enrichment of *Alicyclobacillus*, in fruit juices and other acidic foods, according to IFU standard method No. 12.

- After autoclaving adjust the pH to 3.7 ±0.2 by adding 1N HCl.

PRESENTATION	TYPE OF PACKAGING	ART. NO.	FOOD & BEVERAGES	WATER	CLINICAL	PHARMA	COSMETICS	ENVIRONMENTAL	MOLECULAR
500 g*		02-673-500	●						

YEPD BROTH, see YEAST EXTRACT PEPTONE DEXTROSE BROTH, page 124

YERSINIA CIN AGAR BASE



➤ CIN AGAR



➤ YERSINIA SELECTIVE AGAR

➤ CEFSULODIN-IRGASAN®-NOVOBIOICIN AGAR BASE

01-444
AOAC / BAM / ISO

Solid differential medium used for the selective isolation of *Yersinia spp.* from highly polluted samples, according to ISO 10273 standard.

This medium requires add Yersinia Selective Supplement (Art. No. 06-143LY01).

PRESENTATION	TYPE OF PACKAGING	ART. NO.	FOOD & BEVERAGES	WATER	CLINICAL	PHARMA	COSMETICS	ENVIRONMENTAL	MOLECULAR
500 g*		01-444-500	●		●				
Yersinia Selective Supplement. 10 vials		06-143LY01	●		●				

YGC BROTH, see CHLORAMPHENICOL GLUCOSE AGAR (CGA), page 53

YM AGAR, see YEAST MALT AGAR, page 125

YM BROTH, see YEAST MALT BROTH, page 125

YSG AGAR, see YEAST STARCH GLUCOSE AGAR, page 125

YSG BROTH, see YEAST STARCH GLUCOSE BROTH, page 126



*For dehydrated media presented in a 500 g package, we are able to offer other formats, including 5 and 25 kg. More information at: helpdesk@scharlab.com.

CONSUMABLES FOR MICROBIOLOGY

Scharlab offers a variety of Scharlab branded consumables suitable to be used in microbiology laboratories, from initial sampling to the inoculation. Along with our Scharlab culture media, you can complete your processes in microbiological controls.



Sterile bags for homogenisation, with and without filter

Universal tips and filter tips for automatic pipettes



90 mm Petri dishes

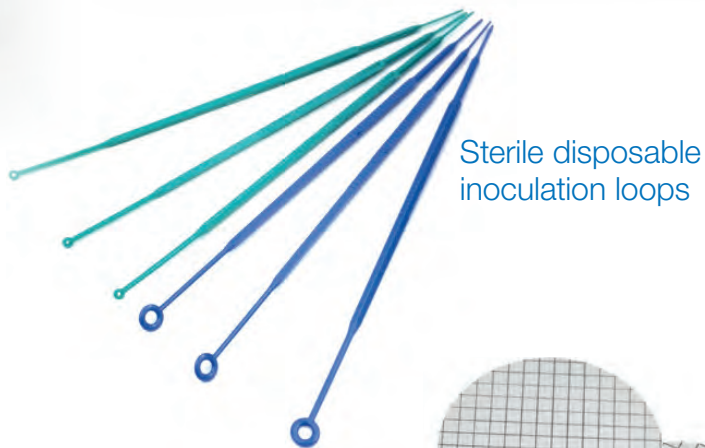

Sterile disposable inoculation loops



Download here the brochure

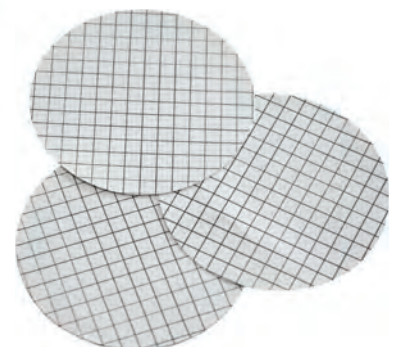

Filtration membranes

CHROMOGENIC MEDIA MICROINSTANT®

COLIFORM AGAR BASE (ISO) CHROMOGENIC MICROINSTANT®

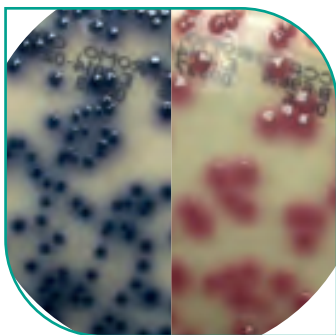

➤ CCA ➤ ACC

01-797
EN / ISO

Selective and differential medium for the detection and enumeration of coliforms and *E. coli* in water samples by MF technique according to ISO 9308-1.

PRESENTATION	TYPE OF PACKAGING	ART. NO.	FOOD & BEVERAGES	WATER	CLINICAL	PHARMA	COSMETICS	ENVIRONMENTAL	MOLECULAR
500 g*	📦	01-797-500	●	●					
5x500 ml	📦	01-797BA05	●	●					
20 plates of 90 mm Ø	📦	064-PA6065	●	●					
30 plates of 55 mm Ø	📦	064-PF6021	●	●		●			

COLIFORM AGAR BASE CHROMOGENIC MICROINSTANT®

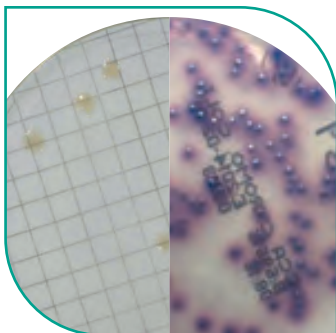

➤ CCA ➤ ACC ➤ CHROMOGENIC COLISTANT AGAR

01-695
BOE

Selective and differential medium for the detection of total coliforms and *E. coli* in water samples by membrane filter method according to ISO 7704. Used in combination with selective supplement for coliforms (Art. No. 06-140LYO1) for inhibition of *Pseudomonas* and *Enterococcus*, it is especially suitable for water analysis.

PRESENTATION	TYPE OF PACKAGING	ART. NO.	FOOD & BEVERAGES	WATER	CLINICAL	PHARMA	COSMETICS	ENVIRONMENTAL	MOLECULAR
500 g*	📦	01-695-500	●	●				●	
5x500 ml	📦	01-695BA05	●	●				●	
30 plates of 55 mm Ø	📦	064-PF1015	●	●				●	
Coliform CV Selective Supplement. 10 vials	📦	06-140LYO1	●	●				●	

**COLINSTANT AGAR
CHROMOGENIC
MICROINSTANT®**

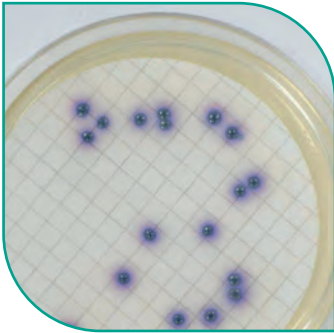

01-618

Solid selective and differential medium for the detection of total coliforms and *E. coli* in water and food samples. Need Coliform CV Selective Supplement (Art. No. 06-140LY01).

PRESENTATION	TYPE OF PACKAGING	SPECIFICATIONS	ART. NO.	FOOD & BEVERAGES	WATER	CLINICAL	PHARMA	COSMETICS	ENVIRONMENTAL	MOLECULAR
500 g*	☐		01-618-500	●	●					
5x500 ml	☐		01-618BA05	●	●					
10 flasks with 100 ml	☐	Metallic-non injectable cap	064-BA7040	●	●	●		●		
Coliform CV Selective Supplement. 10 vials.	☐		06-140LY01	●	●					

**CRONOBACTER ISOLATION
AGAR (CCI) CHROMOGENIC
MICROINSTANT®**

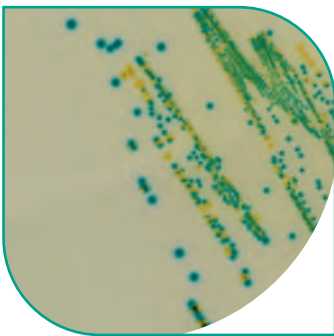

**01-828
ISO**

A solid medium, selective and differential for the presumptive isolation of *Cronobacter sakasaki* (*E. sakasaki*) in samples of milk and dairy products, according to ISO / TS 22964:2017 and IDF / RM 210.

DESCRIPTION	TYPE OF PACKAGING	ART. NO.	FOOD & BEVERAGES	WATER	CLINICAL	PHARMA	COSMETICS	ENVIRONMENTAL	MOLECULAR
500 g*	☐	01-828-500	●		●				

MiStraCon®
Microbiologic Strains for Control

ATCC Licensed
Derivative®

Traceability with the strains of the American Type Culture Collection (ATCC®)



Wide range of microbial strains for microbiological control.
Available in 3 different formats.



LISTERIA OTTAVIANI & AGOSTI AGAR MICROINSTANT®

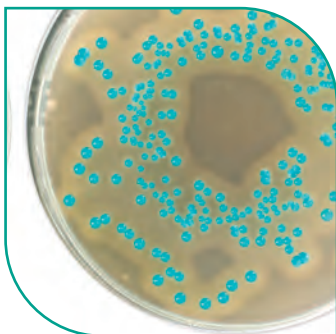

01-719
ISO

Solid medium for the isolation of *Listeria spp.* and the presumptive identification of *Listeria monocytogenes* according to ISO 11290-1 and 11290-2 standard. Need enrichment Supplement for Agar Listeria O&A (06-754-024) and selective supplement for Agar Listeria O&A (06-755LYO1).

PRESENTATION	TYPE OF PACKAGING	ART. NO.	FOOD & BEVERAGES	WATER	CLINICAL	PHARMA	COSMETICS	ENVIRONMENTAL	MOLECULAR
500 g*	☐	01-719-500	●						
5x500 ml	☐	01-719BA05	●						
20 plates of 90 mm Ø	☉	064-PA0084	●						
Microinstant® Listeria Selective Supplement. 10 vials	☐	06-755LY01	●						
Microinstant® Listeria Enrichment Supplement. 10 vials	☐	06-754-024	●						

SAKAZAKII AGAR CHROMOGENIC MICROINSTANT®



► ESIA

01-744
IDF / ISO

Chromogenic solid medium, selective and differential for the presumptive isolation of *Cronobacter sakazakii* (*E. sakazakii*) in samples of milk and dairy products, according to ISO/TS 22964 and IDF/RM 210.

DESCRIPTION	TYPE OF PACKAGING	ART. NO.	FOOD & BEVERAGES	WATER	CLINICAL	PHARMA	COSMETICS	ENVIRONMENTAL	MOLECULAR
500 g*	☐	01-744-500	●						
5x500 ml	☐	01-744BA05	●						
20 plates of 90 mm Ø	☉	064-PA0146	●		●				

TRYPTONE BILE GLUCURONIC AGAR (TBX AGAR) MICROINSTANT®

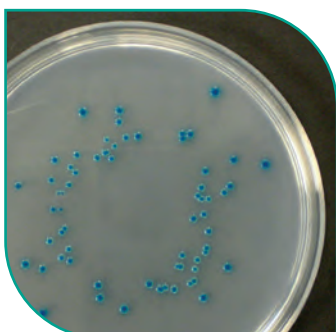

► TBX AGAR

01-619
ISO / SL

Selective and differential solid medium for the detection and enumeration of β -glucuronidasepositive *Escherichia coli* according to ISO 16649-1 and 16649-2 standards.

PRESENTATION	TYPE OF PACKAGING	SPECIFICATIONS	ART. NO.	FOOD & BEVERAGES	WATER	CLINICAL	PHARMA	COSMETICS	ENVIRONMENTAL	MOLECULAR
500 g*	☐		01-619-500	●	●					
5x500 ml	☐		01-619BA05	●	●					
20 plates of 90 mm Ø	☉		064-PA0945	●	●					
10 flasks with 100 ml	☐	Metallic-non injectable cap	064-BA0945	●	●					
10 flasks with 200 ml	☐	Metallic-non injectable cap	064-BA7945	●	●					



NEW CATALOGUE

Chemicals and Reagents

Chemicals,
Organic Standards,
Chromatography,
Glassware
and Consumables



CHROMOGENIC MEDIA CHROMAGAR™

AquaCHROM™ ECC



Chromogenic medium without agar for the simultaneous detection of coliforms and *E. coli* in 100 ml water. No need UV lamp.

PRESENTATION	TYPE OF PACKAGING	ART. NO.	SECTOR
100 tests (10 bags of 10 flasks)	📦	000000X056	FOOD & BEVERAGES WATER CLINICAL PHARMA COSMETICS ENVIRONMENTAL MOLECULAR

CHROMagar™ ACINETOBACTER

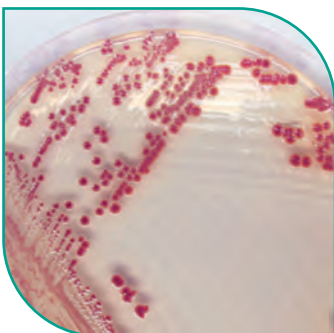

Dehydrated chromogenic medium for detection of *Acinetobacter* spp.

PRESENTATION	TYPE OF PACKAGING	ART. NO.	SECTOR
Dehydrated medium to prepare 5 litres	📦	00000AC092	FOOD & BEVERAGES WATER CLINICAL PHARMA COSMETICS ENVIRONMENTAL MOLECULAR

CHROMagar™ B. CEREOUS

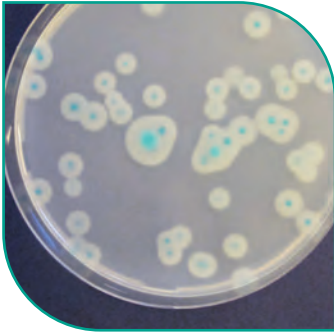

Chromogenic dehydrated medium for detection and enumeration of *Bacillus cereus* in environmental and food samples. No need to add egg yolk emulsion.

PRESENTATION	TYPE OF PACKAGING	ART. NO.	FOOD & BEVERAGES	WATER	CLINICAL	PHARMA	COSMETICS	ENVIRONMENTAL	MOLECULAR
Dehydrated medium to prepare 5 litres	☐	00000BC732	●						

CHROMagar™ 3GR

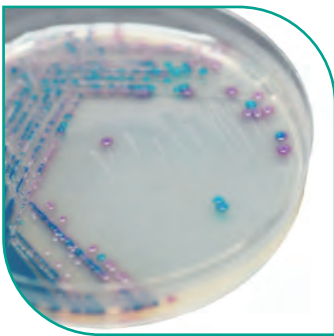

Chromogenic medium for overnight detection of gram-negative bacteria producing extended spectrum β-lactamase.

The product is composed of a powder base (CHROMagar™ Orientation) and 1 supplement (CHROMagar™ C3GR supplement).

PRESENTATION	TYPE OF PACKAGING	ART. NO.	FOOD & BEVERAGES	WATER	CLINICAL	PHARMA	COSMETICS	ENVIRONMENTAL	MOLECULAR
Dehydrated medium to prepare 5 litres	☐	00000CGR2	●						

CHROMagar™ CAMPYLOBACTER

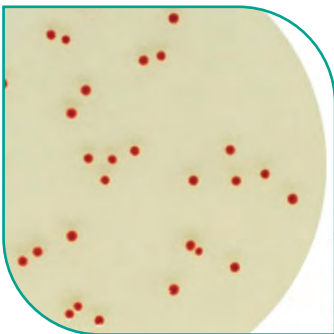

Dehydrated chromogenic medium for detection, differentiation and enumeration of the thermotolerant *Campylobacter*.

PRESENTATION	TYPE OF PACKAGING	ART. NO.	FOOD & BEVERAGES	WATER	CLINICAL	PHARMA	COSMETICS	ENVIRONMENTAL	MOLECULAR
Dehydrated medium to prepare 5 litres	☐	00000CP572	●		●				
Dehydrated medium to prepare 25 litres	☐	00000CP573	●		●				

CHROMagar™ CANDIDA

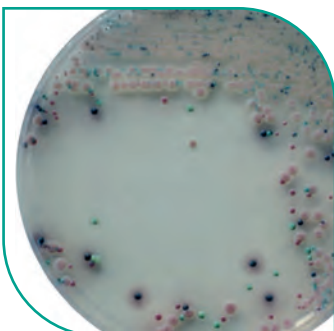

Chromogenic dehydrated medium for the isolation and differentiation of major clinical-significant *Candida* species.

PRESENTATION	TYPE OF PACKAGING	ART. NO.	FOOD & BEVERAGES	WATER	CLINICAL	PHARMA	COSMETICS	ENVIRONMENTAL	MOLECULAR
Dehydrated medium to prepare 5 litres	☐	00000CA222			●				
Dehydrated medium to prepare 25 litres	☐	00000CA223			●				
20 plates 90 mm Ø	Ⓜ	064-PA0076			●				

CHROMagar™ CCA

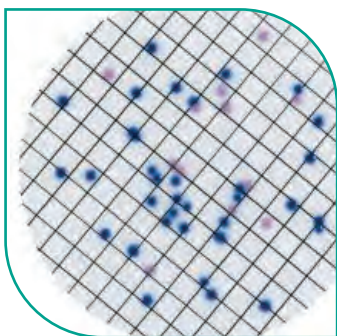

Chromogenic Coliform Agar for the detection and enumeration of β -glucuronidase positive *E. coli* and coliforms in water with low bacterial background flora (according to the ISO 9308-1 standard).

PRESENTATION	TYPE OF PACKAGING	ART. NO.	FOOD & BEVERAGES	WATER	CLINICAL	PHARMA	COSMETICS	ENVIRONMENTAL	MOLECULAR
Dehydrated medium to prepare 5 litres	<input type="checkbox"/>	00000EF342	●	●					

CHROMagar™ C. DIFFICILE

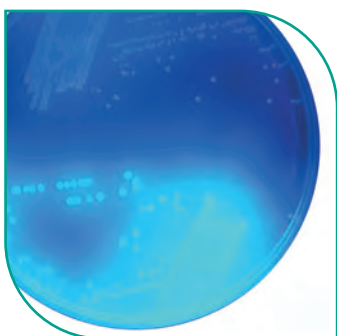

Fluorogenic dehydrated medium extremely sensitive and selective for isolation and direct differentiation of *Clostridium difficile*.

PRESENTATION	TYPE OF PACKAGING	ART. NO.	FOOD & BEVERAGES	WATER	CLINICAL	PHARMA	COSMETICS	ENVIRONMENTAL	MOLECULAR
Dehydrated medium to prepare 5 litres	<input type="checkbox"/>	00000CD122					●		

CHROMagar™ C. PERFRINGENS

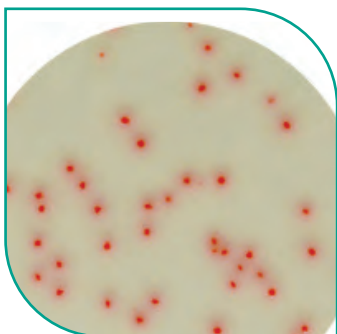

Chromogenic dehydrated medium for detection and enumeration of *Clostridium perfringens*.

PRESENTATION	TYPE OF PACKAGING	ART. NO.	FOOD & BEVERAGES	WATER	CLINICAL	PHARMA	COSMETICS	ENVIRONMENTAL	MOLECULAR
Dehydrated medium to prepare 5 litres	<input type="checkbox"/>	00000PF652	●	●				●	

CHROMagar™ ECC

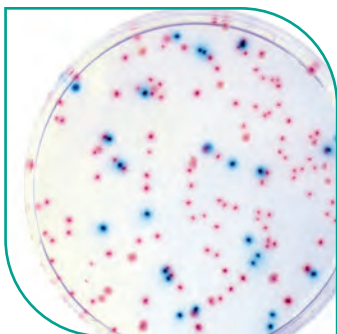

Chromogenic dehydrated medium for the simultaneous detection and enumeration of *E. coli* and other coliforms in food and water samples.

PRESENTATION	TYPE OF PACKAGING	ART. NO.	FOOD & BEVERAGES	WATER	CLINICAL	PHARMA	COSMETICS	ENVIRONMENTAL	MOLECULAR
Dehydrated medium to prepare 5 litres	<input type="checkbox"/>	00000EF322	●	●					
Dehydrated medium to prepare 25 litres	<input type="checkbox"/>	00000EF323	●	●					

CHROMagar™ E. COLI

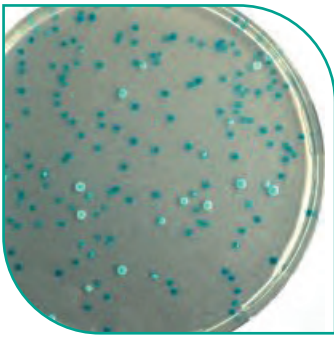

Chromogenic dehydrated medium for detection and enumeration of *E. coli* in food and water samples.

PRESENTATION	TYPE OF PACKAGING	ART. NO.	FOOD & BEVERAGES	WATER	CLINICAL	PHARMA	COSMETICS	ENVIRONMENTAL	MOLECULAR
Dehydrated medium to prepare 5 litres	☐	00000EC168	●	●					
Dehydrated medium to prepare 25 litres	☐	00000EC169	●	●					

CHROMagar™ ENTEROBACTERIA

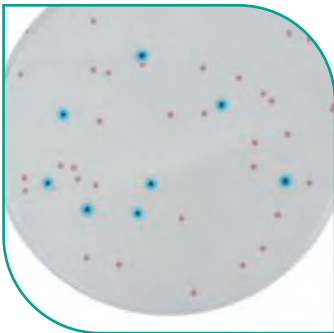

Chromogenic medium for detection and enumeration of *Enterobacteriaceae*.

PRESENTATION	TYPE OF PACKAGING	ART. NO.	FOOD & BEVERAGES	WATER	CLINICAL	PHARMA	COSMETICS	ENVIRONMENTAL	MOLECULAR
Dehydrated medium to prepare 5 litres	☐	00000EB042	●	●					

CHROMagar™ E. SAKAZAKII

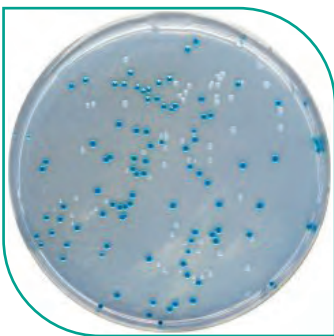

Chromogenic medium for detection of *E. sakazakii* in food, mainly powdered milk, according to the ISO/TS 22964 standard.

PRESENTATION	TYPE OF PACKAGING	ART. NO.	FOOD & BEVERAGES	WATER	CLINICAL	PHARMA	COSMETICS	ENVIRONMENTAL	MOLECULAR
Dehydrated medium to prepare 5 litres	☐	00000CS812	●						

CHROMagar™ ESBL

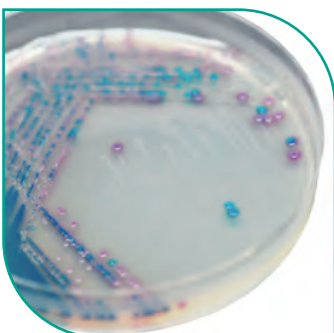

Chromogenic medium for overnight detection of gram-negative bacteria producing extended spectrum β -lactamase.

The product is composed of a powder base (CHROMagar™ Orientation) and 1 supplement (CHROMagar™ ESBL supplement).

PRESENTATION	TYPE OF PACKAGING	ART. NO.	FOOD & BEVERAGES	WATER	CLINICAL	PHARMA	COSMETICS	ENVIRONMENTAL	MOLECULAR
Dehydrated medium to prepare 5 litres	☐	00000ESRT2			●				
20 plates 90 mm Ø	⊙	064-PA1039			●				

CHROMagar™ IDENTIFICATION LISTERIA

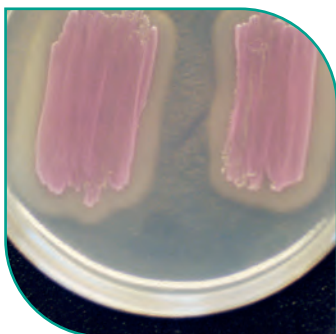

Chromogenic medium for confirmation of *Listeria monocytogenes* species from suspect colonies on CHROMagar™ Listeria. Combined with the medium (Art. No. 00000LM852, CHROMagar™ Listeria) allows the simple confirmation of *Listeria monocytogenes* in 2 days.

PRESENTATION	TYPE OF PACKAGING	ART. NO.	FOOD & BEVERAGES	WATER	CLINICAL	PHARMA	COSMETICS	ENVIRONMENTAL	MOLECULAR
Dehydrated medium to prepare 250 ml	<input type="checkbox"/>	00000LK970	●						

CHROMagar™ KPC

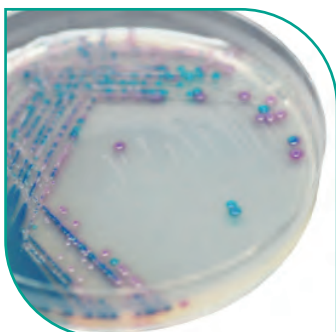

Chromogenic medium for detection of gram-negative bacteria with a reduced susceptibility to most of the carbapenem agents.

The product is composed of a powder base (CHROMagar™ Orientation) and 1 supplement (CHROMagar™ KPC supplement).

PRESENTATION	TYPE OF PACKAGING	ART. NO.	FOOD & BEVERAGES	WATER	CLINICAL	PHARMA	COSMETICS	ENVIRONMENTAL	MOLECULAR
Dehydrated medium to prepare 5 litres	<input type="checkbox"/>	00000KPRT2	●						

CHROMagar™ LIQUID ECC

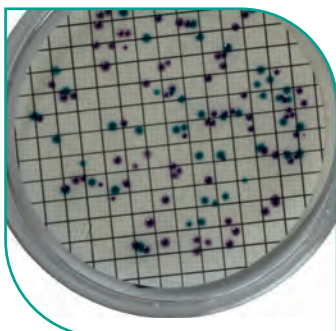

Chromogenic dehydrated medium for the simultaneous detection and enumeration of *E. coli* and other coliforms in water samples.

PRESENTATION	TYPE OF PACKAGING	ART. NO.	FOOD & BEVERAGES	WATER	CLINICAL	PHARMA	COSMETICS	ENVIRONMENTAL	MOLECULAR
Dehydrated medium to prepare 5 litres	<input type="checkbox"/>	00000EL382		●					

CHROMagar™ LISTERIA

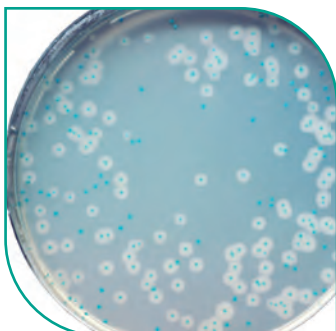

Chromogenic dehydrated medium for detection, differentiation, enumeration and confirmation of *Listeria monocytogenes* from other bacteria in food samples.

PRESENTATION	TYPE OF PACKAGING	ART. NO.	FOOD & BEVERAGES	WATER	CLINICAL	PHARMA	COSMETICS	ENVIRONMENTAL	MOLECULAR
Dehydrated medium to prepare 5 litres	<input type="checkbox"/>	00000LM852	●						

CHROMagar™ MALASSEZIA

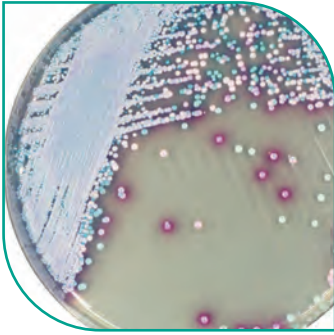

Chromogenic dehydrated medium for detection of *Malassezia* spp.

PRESENTATION	TYPE OF PACKAGING	ART. NO.	FOOD & BEVERAGES	WATER	CLINICAL	PHARMA	COSMETICS	ENVIRONMENTAL	MOLECULAR
Dehydrated medium to prepare 5 litres	☐	00000MZ282	●		●				

CHROMagar™ MASTITIS

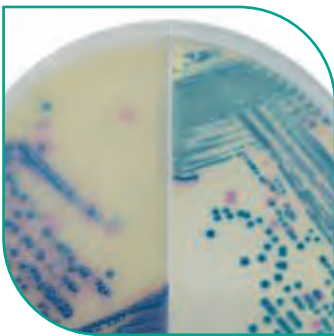

Chromogenic medium for a fast and simple differentiation of the bacteria involved in mastitis infections (kit with 2 different chromogenic media, one for other Gram positive bacteria and to Gram-negative bacteria).

PRESENTATION	TYPE OF PACKAGING	ART. NO.	FOOD & BEVERAGES	WATER	CLINICAL	PHARMA	COSMETICS	ENVIRONMENTAL	MOLECULAR
Dehydrated medium to prepare 5 litres	☐	00000MS252	●						

CHROMagar™ MRSA

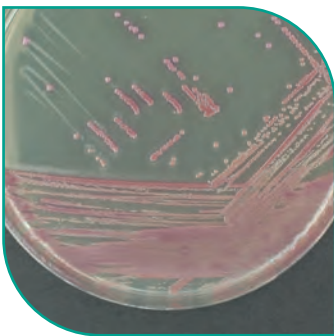

Chromogenic dehydrated medium for isolation and differentiation of Methicillin Resistant *Staphylococcus aureus* (MRSA), including low level MRSA.

PRESENTATION	TYPE OF PACKAGING	ART. NO.	FOOD & BEVERAGES	WATER	CLINICAL	PHARMA	COSMETICS	ENVIRONMENTAL	MOLECULAR
Dehydrated medium to prepare 5 litres	☐	00000MR502							●

CHROMagar™ mSuperCARBA™

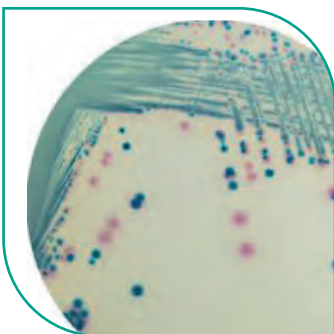

Chromogenic medium for detection and isolation of Carbapenemase-producing Enterobacteriaceae (CPE). The product is composed of a powder base (B) and 2 supplements S1 (Growth factors mix) + S2 (Selective mix).

PRESENTATION	TYPE OF PACKAGING	ART. NO.	FOOD & BEVERAGES	WATER	CLINICAL	PHARMA	COSMETICS	ENVIRONMENTAL	MOLECULAR
Dehydrated medium to prepare 5 litres	☐	00000SC172							●
20 plates of 90 mm Ø	⊕	064-PA6079							●

CHROMagar™ 0157

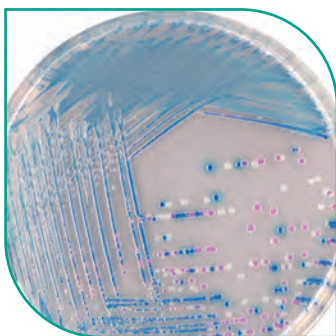

Chromogenic dehydrated medium for the selective isolation and differentiation of *E. coli* O157 in clinical and food samples. Medium alternative to Sorbitol MacConkey Agar. The selectivity of the medium can be increased by adding Potassium tellurite.

PRESENTATION	TYPE OF PACKAGING	ART. NO.	FOOD & BEVERAGES	WATER	CLINICAL	PHARMA	COSMETICS	ENVIRONMENTAL	MOLECULAR
Dehydrated medium to prepare 5 litres	☐	0000EE222	●		●				
Dehydrated medium to prepare 25 litres	☐	0000EE223	●		●				

CHROMagar™ ORIENTATION



Chromogenic dehydrated medium for isolation and differentiation of urinary tract pathogens. It can also be used as a general nutrient agar for the isolation of pathogens.

PRESENTATION	TYPE OF PACKAGING	ART. NO.	FOOD & BEVERAGES	WATER	CLINICAL	PHARMA	COSMETICS	ENVIRONMENTAL	MOLECULAR
Dehydrated medium to prepare 5 litres	☐	0000RT412	●		●				
Dehydrated medium to prepare 25 litres	☐	0000RT413	●		●				
20 plates of 90 mm Ø	⊗	064-PA0077	●		●				

CHROMagar™ PSEUDOMONAS

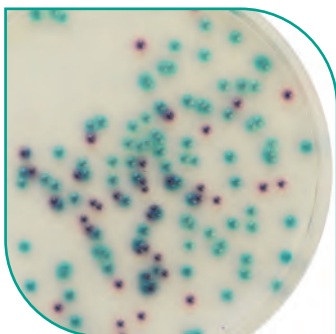

Chromogenic dehydrated medium for isolation and detection of *Pseudomonas* spp. Applicable to the membrane filtration technique.

PRESENTATION	TYPE OF PACKAGING	ART. NO.	FOOD & BEVERAGES	WATER	CLINICAL	PHARMA	COSMETICS	ENVIRONMENTAL	MOLECULAR
Dehydrated medium to prepare 5 litres	☐	0000PS832	●		●				
30 plates of 55 mm Ø	☐	064-PF6025	●	●					

CHROMagar™ SALMONELLA

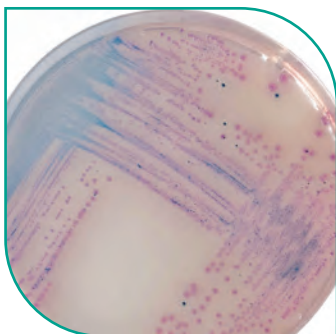

Chromogenic dehydrated medium for detection and isolation of *Salmonella*.

PRESENTATION	TYPE OF PACKAGING	ART. NO.	FOOD & BEVERAGES	WATER	CLINICAL	PHARMA	COSMETICS	ENVIRONMENTAL	MOLECULAR
Dehydrated medium to prepare 5 litres	☐	0000SA132			●				
Dehydrated medium to prepare 25 litres	☐	0000SA133			●				

**CHROMagar™
SALMONELLA PLUS**

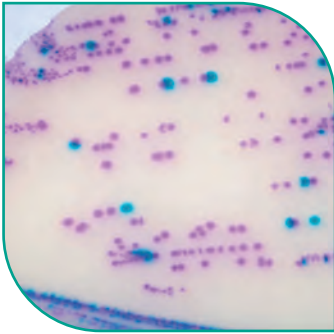

Chromogenic dehydrated medium for detection and isolation of *Salmonella* species including lactose positive *Salmonella* in food specimens according to ISO 6579 standard.

PRESENTATION	TYPE OF PACKAGING	ART. NO.	SECTOR							
			FOOD & BEVERAGES	WATER	CLINICAL	PHARMA	COSMETICS	ENVIRONMENTAL	MOLECULAR	
Dehydrated medium to prepare 5 litres	<input type="checkbox"/>	00000SA162	●							
Dehydrated medium to prepare 25 litres	<input type="checkbox"/>	00000SA163	●							
20 plates 90 mm Ø	<input checked="" type="checkbox"/>	064-PA0083	●							
Opaque supplement for 25 litres	<input type="checkbox"/>	00SU703-25	●							

CHROMagar™ STAPH AUREUS

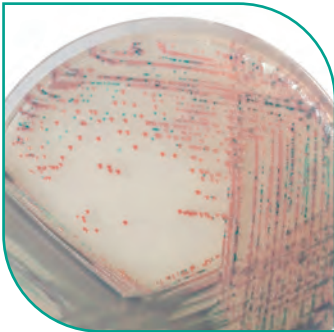

Chromogenic dehydrated medium for isolation and direct differentiation of *Staphylococcus aureus*.

PRESENTATION	TYPE OF PACKAGING	ART. NO.	SECTOR							
			FOOD & BEVERAGES	WATER	CLINICAL	PHARMA	COSMETICS	ENVIRONMENTAL	MOLECULAR	
Dehydrated medium to prepare 5 litres	<input type="checkbox"/>	00000TA672	●		●					

**CHROMagar™
STAPHYLOCOCCUS**

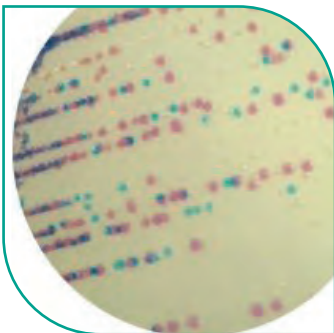

Chromogenic dehydrated medium for the detection and isolation of *Staphylococcus* spp.

PRESENTATION	TYPE OF PACKAGING	ART. NO.	SECTOR							
			FOOD & BEVERAGES	WATER	CLINICAL	PHARMA	COSMETICS	ENVIRONMENTAL	MOLECULAR	
Dehydrated medium to prepare 5 litres	<input type="checkbox"/>	00000CQ382	●							

CHROMagar™ STEC

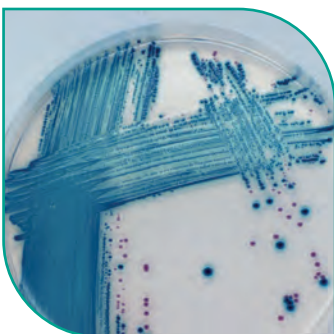

Chromogenic dehydrated medium for detection of Shiga-Toxin producing *E. coli* (STEC).

PRESENTATION	TYPE OF PACKAGING	ART. NO.	SECTOR							
			FOOD & BEVERAGES	WATER	CLINICAL	PHARMA	COSMETICS	ENVIRONMENTAL	MOLECULAR	
Dehydrated medium to prepare 5 litres	<input type="checkbox"/>	00000ST162	●		●					

CHROMagar™ STREP B

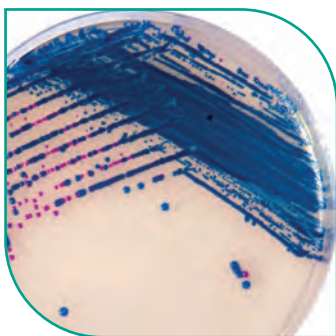

Chromogenic dehydrated medium for the isolation and differentiation of *Streptococcus agalactiae* (GBS).

PRESENTATION	TYPE OF PACKAGING	ART. NO.	FOOD & BEVERAGES	WATER	CLINICAL	PHARMA	COSMETICS	ENVIRONMENTAL	MOLECULAR
Dehydrated medium to prepare 5 litres	<input type="checkbox"/>	00000SB282			●				
Dehydrated medium to prepare 25 litres	<input type="checkbox"/>	00000SB283			●				

CHROMagar™ STREPTOCOCCUS

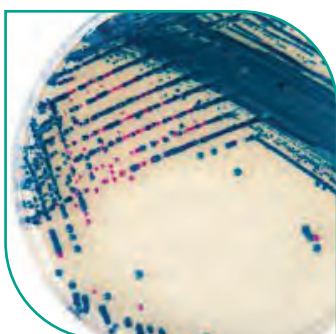

Chromogenic dehydrated medium for detection and isolation of *Streptococcus spp.*

PRESENTATION	TYPE OF PACKAGING	ART. NO.	FOOD & BEVERAGES	WATER	CLINICAL	PHARMA	COSMETICS	ENVIRONMENTAL	MOLECULAR
Dehydrated medium to prepare 5 litres	<input type="checkbox"/>	00000CQ392	●						

CHROMagar™ VIBRIO



Chromogenic dehydrated medium for isolation and detection of *V. parahaemolyticus*, *V. vulnificus* and *V. cholerae*.

PRESENTATION	TYPE OF PACKAGING	ART. NO.	FOOD & BEVERAGES	WATER	CLINICAL	PHARMA	COSMETICS	ENVIRONMENTAL	MOLECULAR
Dehydrated medium to prepare 5 litres	<input type="checkbox"/>	00000VB912	●						

CHROMagar™ VRE

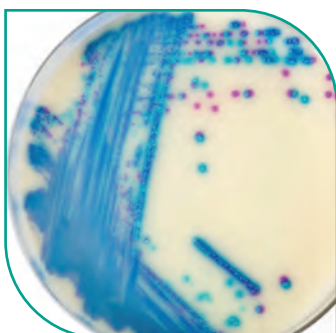

Chromogenic dehydrated medium for detection of Van A / Van B VRE: *faecalis* & VRE: *faecium*.

PRESENTATION	TYPE OF PACKAGING	ART. NO.	FOOD & BEVERAGES	WATER	CLINICAL	PHARMA	COSMETICS	ENVIRONMENTAL	MOLECULAR
Dehydrated medium to prepare 5 litres	<input type="checkbox"/>	00000VR952			●				
Dehydrated medium to prepare 25 litres	<input type="checkbox"/>	00000VR953			●				

CHROMagar™ YERSINIA ENTEROCOLITICA

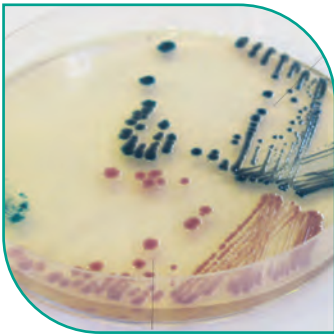

Chromogenic dehydrated medium for detection and direct differentiation of pathogenic *Yersinia enterocolitica*.

PRESENTATION	TYPE OF PACKAGING	ART. NO.	FOOD & BEVERAGES	WATER	CLINICAL	PHARMA	COSMETICS	ENVIRONMENTAL	MOLECULAR
Dehydrated medium to prepare 5 litres	☐	00000YE492	●		●				

RAMBACH™ AGAR

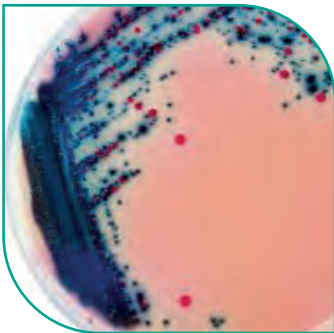

Chromogenic dehydrated medium for detection and isolation of *Salmonella* species in clinical and food samples.

PRESENTATION	TYPE OF PACKAGING	ART. NO.	FOOD & BEVERAGES	WATER	CLINICAL	PHARMA	COSMETICS	ENVIRONMENTAL	MOLECULAR
Dehydrated medium to prepare 5 litres	☐	00000RR702	●						
Dehydrated medium to prepare 25 litres	☐	00000RR703	●						
20 plates 90 mm Ø	⊙	064-PA0082	●						

RAMBAQUICK™ SALMONELLA

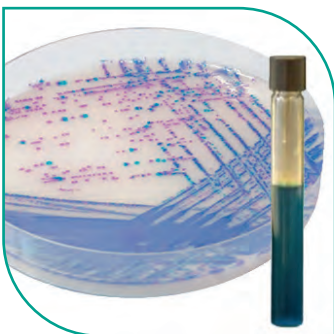

Enrichment broth for rapid detection of *Salmonella* species.

PRESENTATION	TYPE OF PACKAGING	ART. NO.	FOOD & BEVERAGES	WATER	CLINICAL	PHARMA	COSMETICS	ENVIRONMENTAL	MOLECULAR
Dehydrated medium to prepare 1 litre	☐	00000SQ001	●		●				

CHROMOGENIC MEDIA COMPACT DRY®

COMPACT DRY® AQ

The plate contains a nutrient-poor medium for determining the colony count of heterotrophic organisms in treated drinking water and ultra-pure water.

PRESENTATION	TYPE OF PACKAGING	ART. NO.
40 plates	☉	0001002960
240 plates	☉	0001002951

COMPACT DRY® CF (Coliforms)

Coliforms detection medium.

PRESENTATION	TYPE OF PACKAGING	ART. NO.
40 plates	☉	0001000867
240 plates	☉	0001000868

COMPACT DRY® EC (Coliforms and *E. coli*)

Coliforms and *Escherichia coli* detection medium.

PRESENTATION	TYPE OF PACKAGING	ART. NO.
40 plates	☉	0001000168
240 plates	☉	0001000169

COMPACT DRY® ETB (Enterobacterias)

Enterobacterias detection medium.

It recommends to use the temperature according to the specification used in each analysis.

PRESENTATION	TYPE OF PACKAGING	ART. NO.
40 plates	☉	0001002941
240 plates	☉	0001002942

COMPACT DRY® ETC (Enterococos)

Chromogenic medium for detection of Enterococos.

PRESENTATION	TYPE OF PACKAGING	ART. NO.
40 plates	☉	0001002944
240 plates	☉	0001002945

COMPACT DRY® LS (*Listeria spp.*)

Chromogenic medium for detection of *Listeria spp.*

PRESENTATION	TYPE OF PACKAGING	ART. NO.
40 plates	☉	0001000899
240 plates	☉	0001001013

COMPACT DRY® PA

Compact Dry PA meets the properties of dry medium and chromogenic contact plates gel. It serves to confirm the presence of *Pseudomonas aeruginosa* in samples of food, feed, water, cosmetics or other materials samples.

PRESENTATION	TYPE OF PACKAGING	ART. NO.
40 plates	90	0001002947
240 plates	90	0001002948

COMPACT DRY® SL (*Salmonella*)

Salmonella detection medium, after 20-24 hours before enrichment in pre-enrichment broths.

PRESENTATION	TYPE OF PACKAGING	ART. NO.
40 plates	90	0001002973
240 plates	90	0001002938

COMPACT DRY® TC (Total counting)

Total counting medium for aerobic microorganisms.

PRESENTATION	TYPE OF PACKAGING	ART. NO.
40 plates	90	0001000166
240 plates	90	0001000167

COMPACT DRY® VP (*Vibrio parahaemolyticus*)

Vibrio parahaemolyticus detection medium allowing its differentiation from other vibrios, thanks to the presence in the middle of a chromogenic substrate for this organism.

PRESENTATION	TYPE OF PACKAGING	ART. NO.
40 plates	90	0001000900
240 plates	90	0001001014

COMPACT DRY® X-BC (*Bacillus cereus*)

Bacillus cereus detection medium.

PRESENTATION	TYPE OF PACKAGING	ART. NO.
40 plates	90	0001002970
240 plates	90	0001002971

COMPACT DRY® XSA (*Staphylococcus aureus*)

Staphylococcus aureus detection and differentiation medium.

PRESENTATION	TYPE OF PACKAGING	ART. NO.
40 plates	90	0001002950
240 plates	90	0001002961

COMPACT DRY® YM RAPID (Moulds and yeasts)

Moulds and yeasts detection medium.

PRESENTATION	TYPE OF PACKAGING	ART. NO.
40 plates	90	0001000869
240 plates	90	0001000870

COMPACT DRY® SWABS FOR SURFACES

PRESENTATION	ART. NO.
40 swabs	0001002953
240 swabs	0001002952

RACK DILUTION

The dilution rack contains 4 wells of 9 ml peptone water Buffered Saline. Pipetting 1 ml well in well allows a simple way to perform a bank 1/10 dilutions of samples.

PRESENTATION	ART. NO.
Dilution rack	0001000888
Opener	0001000887

ADDITIVES FOR CULTURE MEDIA

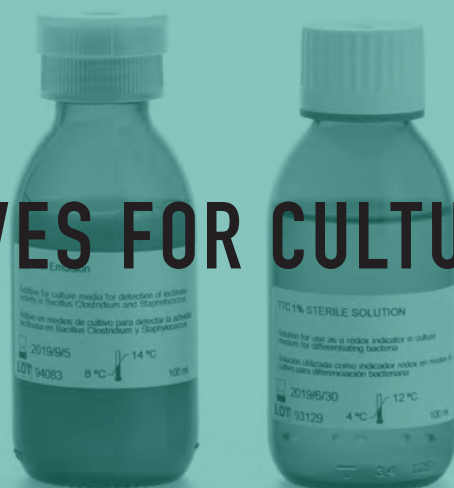

n-ACETYL-CYSTEINE

DESCRIPTION	PRESENTATION	TYPE OF PACKAGING	ART. NO.
N-acetylcysteine	25 g	☐	16028-0250

EGG'S YOLK STERILE EMULSION

06-016

Additive used in culture media for detecting lecithinase in species such as *Bacillus*, *Clostridium* and *Staphylococcus*. Added as an additive to the medium: *Bacillus cereus* Agar Base (MYPA) Art. No. 01-262, *Bacillus cereus* Selective Agar Base (PEMBA Agar) Art. No. 01-487 and Tryptose Sulfite Cycloserine Agar Base (TSC Agar) Art. No. 01-278.

DESCRIPTION	PRESENTATION	TYPE OF PACKAGING	ART. NO.
Egg's Yolk sterile Emulsion	50 ml	☐	0BA1019-50
Egg's Yolk sterile Emulsion	100 ml	☐	06-016-100

EGG'S YOLK TELLURITE STERILE EMULSION

064-BA1018

Additive specially formulated to be added to the Baird-Parker Agar Base Art. No. 01-030.

DESCRIPTION	PRESENTATION	TYPE OF PACKAGING	ART. NO.
Egg's Yolk Tellurite sterile Emulsion	50 ml	☐	0BA1018-50
Egg's Yolk Tellurite sterile Emulsion	100 ml	☐	064-BA1018
Egg's Yolk Tellurite sterile Emulsion with NaCl	100 ml	☐	06-026-100

IODINE POTASSIUM- IODIDE SOLUTION

064-V11108 ISO

Iodine solution for addition to Müller Kaufman Tetrathionate Novobiocine medium (Art. No. 02-335) formulated according to ISO 6579.

DESCRIPTION	PRESENTATION	TYPE OF PACKAGING	ART. NO.
Iodine-iodide solution	50 ml	☐	064-V11108
Potassium iodide	250 g	☐	P004100250
Iodine	100 g	☐	Y000210100

β-LACTAMASE PENASE 20.000 UL/ml

064-V11111 EP / USP

Sterile reagent to be added, as inhibitor of beta-lactamic antibiotics, into many microbiological culture media according to European Pharmacopoeia 6.0 and USP 32- NF 27.

DESCRIPTION	PRESENTATION	TYPE OF PACKAGING	ART. NO.
β-Lactamase PENASE 20.000 UL/ml	1 flask of 100 ml	☐	064-V11111

POLYSORBATE 80 (POLYOXYETHYLENE SORBITAN MONOOLEATE)

TW0080

Additive for culture media. In some cases acts as a nutrient and other emulsifier.

DESCRIPTION	PRESENTATION	TYPE OF PACKAGING	ART. NO.
Polysorbate 80	100 ml	☐	TW00800100
Polysorbate 80	1 litre	☐	TW00801000

POTASSIUM TELLURITE STERILE SOLUTION

Additive for selective media for *Staphylococcus*, *Corynebacterium*, *Streptococcus* and *Vibrio*. Its function is to prevent the growth of most gram-negative and those gram-positive incapable of reducing tellurite. Added to media such as Giolitti Cantoni Broth Art. No. 02-230 and Vogel-Johnson Agar Art. No. 01-206.

DESCRIPTION	PRESENTATION	TYPE OF PACKAGING	ART. NO.
Potassium Tellurite Sterile Solution 1%	100 ml	☐	06-089-100
Potassium Tellurite Sterile Solution 3.5%	100 ml	☐	06-011-100

ROSOLIC ACID SOLUTION 1%

064-BA8005

Additive with alcohol base, indicated to supplement medium m-FC Agar (01-287).

DESCRIPTION	PRESENTATION	TYPE OF PACKAGING	ART. NO.
Rosolic Acid Solution 1%	100 ml	☐	064-BA8005

SKIMMED MILK POWDER

06-019

Bacteriology grade. Can be used alone or as an additive in media for the culture of lactic acid bacteria and identification of microorganisms able to coagulate of peptonise milk. Can be added to media such as TSA Art. No. 01-200 and Nutrient Agar Art. No. 01-144 to detect caseolytic activity.

DESCRIPTION	PRESENTATION	TYPE OF PACKAGING	ART. NO.
Skimmed milk powder	500 g	☐	06-019-500
Skimmed milk powder	5000 g	☐	06-019-005

SODIUM BIASELENITE

S00160

Suitable for incorporation in the following media: Selenite Cystine Broth Base Art. No. 02-602 and Selenite Broth Base Art. No. 02-598.

DESCRIPTION	PRESENTATION	TYPE OF PACKAGING	ART. NO.
Sodium Biselenite	100 g	☐	S001600100

TTC (TRYPHENIL- TETRAZOLIUM CHLORIDE) 1%, STERILE SOLUTION

06-023

Used as an additive in culture media to indicate biological activity, as the colourless form is reduced to an insoluble red pigment, triphenyl formazan, which is easily visible. This product is added in particular to: Chapman TTC Agar Base Art. No. 01-053 and KF Agar Art. No. 01-294.

DESCRIPTION	PRESENTATION	TYPE OF PACKAGING	ART. NO.
TTC sterile solution 1%	100 ml	☐	06-023-100

UREA, STERILE SOLUTION 40%

Urea solution sterilised by filtration suitable for incorporation into culture media, specially Urea Agar Art. No. 01-261 and Urea Broth Art. No. 02- 202.

DESCRIPTION	PRESENTATION	TYPE OF PACKAGING	ART. NO.
Urea, sterile solution 40%	100 ml	☐	06-083-100

VASELINE, STERILE

06-077

Liquid solution that is added to certain media to reach anaerobic conditions. It is specially recommended for addition to tubes with OF Medium Art. No. 03-037.

DESCRIPTION	PRESENTATION	TYPE OF PACKAGING	ART. NO.
Vaseline, sterile	100 ml	☐	06-077-100

INGREDIENTS AND CHEMICAL PRODUCTS FOR MICROBIOLOGY

A selection of necessary ingredients and chemical products for the preparation of culture media.

DESCRIPTION	PRESENTATION	TYPE OF PACKAGING	ART. NO.
Agar Bacteriological	500 g	□	07-004-500
Ammonium chloride, reagent grade	500 g	⊖	AM02730500
L-Arginine extra pure	50 g	⊖	AR01250050
L-Asparagine	25 g	⊖	AS00150025
Beef extract	500 g	□	07-515-500
Bile	500 g	□	07-039-500
Bile salts No. 3	500 g	□	07-525-500
Buffer solution pH = 4.00	250 ml	⊖	SO10040250
Buffer solution pH = 7.00	250 ml	⊖	SO10070250
Casein acid hydrolysate	500 g	□	07-151-500
L-Cysteine hydrochloride anhydrous, extra pure	25 g	⊖	CI03050025
D-Glucose (Dextrose)	500 g	⊖	GL01250500
Ethanol 96% v/v, MultiSolvent®	1 l	⊖	ET00131000
Ethanol absolute, synthesis grade	1 l	⊖	ET00021000
D(-)-Fructose, extra pure	500 g	□	LE00700500
Fuchsin Basic, C.I. 42510	25 g	⊖	FU00600025
Gelatin pancreatic peptone	500 g	□	07-153-500
Gelatin powder for analysis and bacteriology	250 g	⊖	GE00200250
Glycerol, 99.5%	1 l	⊖	GL00261000
L-Histidine hydrochloride monohydrate, extra pure, European Pharmacopoeia	25 g	⊖	HI04050025
Hydrochloric acid, solution 0,1 mol/L (0,1 N)	1 l	⊖	AC07461000
Hydrochloric acid, solution 1 mol/L (1 N)	1 l	⊖	AC07441000
Hydrogen peroxide, 30% w/w, extra pure	1 l	⊖	HI01351000
Immersion oil, for microscopy	100 ml	⊖	AC00310100
L-Isoleucine, extra pure	25 g	⊖	IS01400025
Lactalbumin hydrolysate	500 g	□	07-455-500
D(+)-Lactose monohydrate	500 g	⊖	LA00600500
Lecithin	500 g	□	07-342-500
L-Leucine, pure extra, European Pharmacopoeia, USP	25 g	⊖	LE00550025
Liver Peptone	2500 g	□	07-6140025
L-Lysine monohydrochloride, synthesis grade	1 kg	⊖	LI00351000
Malt extract	500 g	□	07-080-500
Maltose	500 g	⊖	MA01000500
D(-)-Mannitol, reagent grade	500 g	⊖	MA01500500
D(+)-Mannose, for biochemistry	10 g	⊖	MA01600010
Meat extract	500 g	□	07-075-500
Meat peptone	500 g	□	07-152-500

DESCRIPTION	PRESENTATION	TYPE OF PACKAGING	ART. NO.
Mixture No. 3	500 g	□	07-716-500
L-Ornithine hydrochloride, extra pure	25 g	⊖	OR00550025
Potassium iodide, reagent grade, ACS, ISO	250 g	□	PO04100250
Potato peptone	500 g	□	07-620-500
Proteose peptone No. 3	500 g	□	07-625-500
Rosolic acid, C.I. 43800, indicator for microscopy	10 g	⊖	AC19900010
D(+)-Saccharose, extra pure	500 g	⊖	SA00200500
D-Salicin, for biochemistry	25 g	⊖	SA02000025
Skimmed milk, powder	500 g	□	06-019-500
Sodium deoxycholate	100 g	⊖	SO02570100
Sodium deoxycholate	500 g	⊖	SO02570500
Sodium L-glutamate monohydrate, extra pure	500 g	⊖	SO04000500
Sodium pyruvate	100 g	⊖	SO05900100
Sodium pyruvate	500 g	⊖	SO05900500
Sodium pyruvate	500 g	□	07-636-500
D(-)-Sorbitol, extra pure	250 g	⊖	SO08500250
Soy Peptone	500 g	□	07-155-500
D-Trehalose, for bacteriology	5 g	⊖	TR00300005
Triton® X-100, extra pure	1 l	⊖	TR04441000
Tryptone- Casein Pancreatic Peptone (industrial fermentation processes)	500 g	□	07-154-500
Tryptone-Casein Trypsic Peptone (culture media preparation)	500 g	□	07-119-500
Tryptone-Peptone from Casein	500 g	□	07-489-500
L-Tryptophan, extra pure	25 g	⊖	TR04000025
Tryptose	500 g	□	07-197-500
L-Tyrosine, extra pure	100 g	⊖	TI03250100
L-Valine, extra pure	25 g	⊖	VA00550025
D(+)-Xylose, extra pure	100 g	⊖	XI00800100
Yeast extract	500 g	□	07-079-500
Zinc powder, extra pure	500 g	⊖	CI01450500

 5 and 5 kg bulks are available.



SELECTIVE SUPPLEMENTS

Supplements - freeze dried

Freeze dried supplements

By means of the freeze-drying technique we can assure a standardised quality that will yield reliable results without any loss in performance of the selective medium. The freeze-dried solid presentation dissolves easily and quickly.

Screw cap for easy and safe handling

The standard closure offered by other manufactures, which consists of a rubber septum with an outer aluminium cap may lead to undesirable accidents. Its removal requires a tool, takes some time and may cause injuries.

For this reason, we offer our vials with a screw cap a much safer, faster and easier to open as alternative.

You may directly remove the septum from the freeze-dried supplement or alternatively you may use a syringe, perforate our septum with a needle and that way transfer the solvent to the supplement vial.

Presentation

Our standard vials contain sufficient supplement to prepare 500 ml of medium. Each box contains 10 vials of supplement except for some references.

Shelf life and storage

Products can be stored at a wide temperature range between 2° to 25°C. Shelf life is between 3 and 4 years depending on the product.

Fluid rehydration - 6 ml

DESCRIPTION	TYPE OF PACKAGING	ART. NO.
Sterile diluent reconstitution 10 vials		06-756-006





Supplemented preparations

SUPPLEMENT	MICROORGANISMS	TYPE OF PACKAGING	MEDIUM ART. NO.	MEDIUM	ART. NO.
Microinstant® Listeria Enrichment Supplement	Listeria		01-719	Microinstant® Chromogenic Listeria Agar according to Ottaviani & Agosti (01-719)	06-754-024

Freeze-dried supplements

SUPPLEMENT	ART. NO.	MICROORGANISMS	TYPE OF PACKAGING
Ampicillin Selective Supplement	06-126LY01	Aeromonas	
Brilliant Green + Novobiocin Selective Supplement	06-017LY01	Salmonella	
Burkholderia cepacia Selective Supplement	06-737LY01	Burkholderia cepacia	
Burkholderia cepacia Selective Supplement (0FPBL)	06-741LY01	Burkholderia cepacia	
Campylobacter Bolton Selective Supplement	06-131LY01	Campylobacter	
Campylobacter CCDA Selective Supplement	06-133LY01	Campylobacter	
CFC Pseudomonas Selective Supplement	06-726LY01	Pseudomonas	
Chloramphenicol Selective Supplement (25 mg)	06-118LY01	Yeasts and moulds	
CN Pseudomonas Selective Supplement	06-742LY01	Pseudomonas	
Coliform CV Selective Supplement	06-140LY01	Coliform / E. coli	
m-CP Selective Supplement	06-125LY01	Clostridium	
CT SMAC Selective Supplement	06-146LY01	E. coli O157:H7	
Cycloheximide Selective Supplement	06-022LY01	Fermenting microorganisms	
D-Cycloserine Selective Supplement (250 ml of medium)	06-116LY01	Clostridium	
Ferric Ammonium Citrate Supplement (250 mg)	06-112LY01	Listeria	
Ferric Ammonium Citrate Supplement (312 mg)	06-113LY01	Clostridium	
GPS - Growth Promotion Supplement	06-144LY01	Neisseria	 Glucose is included in the diluent vial
Legionella BCYE Growth Supplement	06-137LY01	Legionella	
Legionella BCYE without Cysteine Supplement	06-134LY01	Legionella	
Legionella GVPC Selective Supplement	06-138LY01	Legionella	

  Freeze-dried supplements (10 bottles)



MEDIUM ART. NO.	COMPOSITION PER VIAL	MEDIUM
01-352 01-034	2.5 mg of Ampicilline	Blood Agar Base Blood Agar Base (Columbia)
02-335	5 mg of Brilliant green 20 mg of Novobiocin	Müller-Kauffmann Tetrathionate Broth
01-736	300,000 IU Polymixin B Sulphate 5 mg Gentamicin 1.25 mg Vancomycin	Burkholderia cepacia Selective Agar Base (BCSA)
01-739	300,000 IU Polymixin B Sulphate 100 IU Bacitracin	Burkholderia cepacian Selective Agar Base (OFPBL Base)
02-688	10 mg of Vancomycin 10 mg of Cefoperazone 10 mg of Trimethoprim 5 mg of Anphotericine B sulfate	Bolton Enrichment Broth Base
01-685	16 mg of Cefoperazone 5 mg of Anphotericine B sulfate	Charcoal Cefoperazone Deoxycholate (CCD) Modified Agar Base
01-728	5.0 mg Cetrimide 5.0 mg Fucidin 25.0 mg Cephalosporin	Pseudomonas Agar Base
01-165	25 mg of Chloramphenicol	Sabouraud Dextrose Agar
01-728	100.0 mg Cetrimide 7.5 mg Nalidixic Acid. sodium salt	Pseudomonas Agar Base
01-618 01-695	2.5 mg of Cefsulodin 2.5 mg of Vancomycin	Colinstant Agar Chromogenic Coliform Agar (CCA Agar)
01-513	200 mg of D-Cycloserine 12.5 mg of Polymyxin B sulfate 30 mg of 3-indoxyl-β-D-glucopyranoside 50 mg of Phenolphthalein bi-phosphate 45 mg of Iron III chloride	m-CP Agar Base
01-729	1.25 mg Potassium tellurite 0.025 mg Cefixime	MacConkey Sorbitol Agar
01-210	2 mg of Cycloheximide	WL Nutrient Agar
01-278	100 mg of D-Cycloserine	Tryptose Sulfite Cycloserine Agar (TSC Agar)
02-496	250 mg of Ammonium ferric citrate	Listeria Enrichment Broth Base (Fraser)
02-519	312 mg of Ferric ammonium citrate	Lactose Sulfite Broth Base
01-310	0.1 mg of Vitamin B12 100 mg of L-glutamine 10 mg of Adenine SO ₄ 0.3 mg of Guanine HCl 0.13 mg of p-Aminobenzoic acid 11 mg of L-cystine 2.5 mg of NAD 1 mg of Cocarboxylase 0.2 mg of Ferric nitrate 0.03 mg of Vitamin B1 (Thiamine HCl) 259 mg of Cysteine HCl 1 g of Glucose*	GC Agar Base
01-687 064-PA0017	3.6 g of ACES Buffer 1.4 g of Potassium hydroxid 0.125 g of Ferric pyrophosphate 0.200 mg of L-cysteine HCl	BCYE Legionella Agar Base
064-PA6001	3.6 g of ACES Buffer 1.4 g of Potassium hydroxid 0.125 g of Ferric pyrophosphate	BCYE Legionella Agar Base
064-PA0017	0.5 mg of Vancomycin 40.000 IU of Polymyxin B sulfate 40 mg of Cycloheximide 1.5 g of Glycine (ammonia free)	BCYE Legionella Agar Base

Freeze-dried supplements

SUPPLEMENT	ART. NO.	MICROORGANISMS	TYPE OF PACKAGING
Listeria Selective Supplement for Enrichment (FDA and IDF/FIL)	06-107LY01	<i>Listeria</i>	
Listeria Selective Supplement for Primary Enrichment (UVM I)	06-106LY01	<i>Listeria</i>	
Listeria Selective Supplement for Primary Enrichment Half Fraser (Each vial supplements 225 ml of medium)	06-136LY01	<i>Listeria</i>	
Listeria Selective Supplement for Primary Enrichment Half Fraser (Each vial supplements 500 ml of medium)	06-145LY01	<i>Listeria</i>	
Listeria Selective Supplement for Secondary Enrichment (UVM II / Fraser)	06-111LY01	<i>Listeria</i>	
Listeria Selective Supplement for Secondary Enrichment (UVM II / Fraser) with Ferric Ammonium Citrate (250 mg)	06-790LY01	<i>Listeria</i>	
Microinstant® Listeria Selective Supplement	06-755LY01	<i>Listeria</i>	
MUG Fluorescent Supplement	06-102LY01	Coliform	
Nalidixic Acid Selective Supplement	06-124LY01	<i>Pseudomonas</i>	
Novobiocin Selective Supplement (10 mg)	06-139LY01	<i>Salmonella</i> <i>E. coli</i> O157:H7	
Oxford Agar Selective Supplement	06-127LY01	<i>Listeria</i>	
Oxytetracycline Selective Supplement	06-115LY01	Yeasts and Moulds	
Palcam Agar Selective Supplement	06-110LY01	<i>Listeria</i>	
Polymyxin B sulfate Selective Supplement	06-021LY01	<i>Bacillus cereus</i>	
RPF Supplement (Each vial supplements 100 ml of medium)	064-TA0155	Staphylococci (Coagulase positive)	
Sodium Disulfite (Sodium Meta-Bisulfite) for Bacteriology	06-114LY01	<i>Clostridium</i>	
Vancomycin Selective Supplement (5 mg)	06-712LY01	<i>Cronobacter Sakazakii</i>	
VCNT Selective Supplement	06-142LY01	<i>Neisseria</i>	
Yersinia Selective Supplement	06-143LY01	<i>Yersinia</i>	

  Freeze-dried supplements (10 bottles)



MEDIUM ART. NO.	COMPOSITION PER VIAL	MEDIUM
02-498	20 mg of Nalidixic acid, sodium salt 25 mg of Cycloheximide 7.5 mg of Acriflavine	Listeria Enrichment Broth Base (Lovett)
02-472	10 mg of Nalidixic acid, sodium salt 6 mg of Acriflavine	Listeria Enrichment Broth Base (UVM)
02-496	2.25 mg of Nalidixic acid, sodium salt 2.80 mg of Acriflavine 112.5 mg of Ammonium ferric citrate	Listeria Enrichment Broth Base (Fraser)
02-496	5 mg of Nalidixic acid, sodium salt 6.2 mg of Acriflavine 250 mg of Ammonium ferric citrate	Listeria Enrichment Broth Base (Fraser)
02-496 02-472	10 mg of Nalidixic acid, sodium salt 12.5 mg of Acriflavine	Listeria Enrichment Broth Base (Fraser) Listeria Enrichment Broth Base (UVM)
02-496	10 mg of Nalidixic acid, sodium salt 12.5 mg of Acriflavine 250 mg of Ferric Ammonium Citrate	Listeria Enrichment Broth Base (Fraser)
01-719	38350 IU Polymyxin B 0.025 g Cycloheximide 0.010 g Ceftazimide 0.010 g Nalidixic Acid	Microinstant® Chromogenic Listeria Agar according to Ottaviani & Agosti
01-220	50 mg of MUG (4-methylumbeliferil-β-D glucuronide)	Violet Red Bile Lactose Dextrose Agar (European Pharmacopoeia Medium F)
01-609	7.5 mg of Nalidixic acid, sodium salt	CN Selective Agar Base (Art. No. 01-609)
03-376 02-691	10 mg of Novobiocin, sodium salt	Rappaport Vassiliadis Modified Semi-solid Medium Base Tryptic Soy Broth Modified
01-471	5 mg of Fosfomycin 1 mg of Sodium cefotetan 10 mg of Colistin sulfate 200 mg of Cycloheximide 2.5 mg of Acriflavine	Oxford Agar Base
01-275	50 mg of Oxytetracycline HCl	Sabouraud Oxytetracycline Agar Base (OGYEA)
01-470	5 mg of Polymyxin B sulfate 10 mg of Sodium ceftazidime 2.5 mg of Acriflavine	Palcam Agar Base
01-262 01-487	50.000 IU of Polymyxin B sulfate	Bacillus cereus Agar Base (MYPA) Bacillus cereus Selective Agar Base (PEMBA)
01-030	2.5 ml of Rabbit Plasma - EDTA 0.5 g of Bovine Fibrinogen 2.5 mg of Trypsin Inhibitor 2.5 mg of Potassium Tellurite	Baird Parker Agar
02-519	375 mg of Di-sodium sulfite	Lactose Sulfite Broth Base
02-711	5 mg of Vancomycin	Tryptose Lauryl Sulfate Modified Broth Base (mLST)
01-310	1.5 mg of Vancomycin 3.75 mg of Colistin sulfate 2.5 mg of Trimethoprim 6.250 IU of Nystatin	GC Agar Base
01-444	7.5 mg of Cefsulodin 2 mg of Irgasan® 1.25 mg of Novobiocin	Yersinia CIN Agar Base



MiStraCon® MICROBIOLOGIC STRAINS FOR CONTROL

This catalogue includes the Scharlab MiStraCon® product line of bacterial strains from the American Type Culture Collection (ATCC®) and includes the strains commonly used in the laboratory, in the food industry, pharmaceutical industry, water quality control and clinical settings.

ATCC Licensed
Derivative

Scharlab is authorized by the ATCC® to produce reference cultures (Reference Stock Culture) of primary cultures ATCC® (Reference Culture) and is attached to the program (ATCC® Licensed Derivative® Program). The ATCC Licensed Derivative mark states that Scharlab S.L. is licensed to use these trademarks and to sell products deriving from ATCC® cultures.

MiStraCon® Microbiologic Strains for Control

The ATCC Licensed Derivative mark states that Scharlab S.L. is licensed to use these trademarks and to sell products deriving from ATCC® cultures.

All MiStraCon® products are supplied with detailed instructions for use and have an analysis certificate that guarantees their authenticity, traceability and the number of subcultures made from the original reference culture.

These product lines consist of three product formats:

MiStraCon®Swabs2 format

FORMAT	PACKAGING	CONTENT	CFU	APPLICATIONS/SPECIFICATIONS
MiStraCon®Swabs2	Each unit contains a lyophilized pellet, moisturizing fluid And inoculation swab, all sealed in an aluminized envelope	2 units of MiStraCon®Swabs2	Not quantified	<ul style="list-style-type: none"> - Culture purposes - Daily QC - QC of identification systems and assay kits - QC of antimicrobial susceptibility test - Verification and validation

MiStraCon®QuantyPellets and MiStraCon®QuantyE-Pellets® formats

Quantified bacterial strains presented in a lyophilized pellet ready to use or to prepare quantified dilutions.

FORMAT	PACKAGING	CONTENT	CFU	APPLICATIONS/SPECIFICATIONS
MiStraCon®QuantyPellets	1 box. Each box contains 5 vials of a single quantified microorganism and 5 vials of hydrating fluid.	5 vials with 1 quantified pellet (1 pellet/vial) and 5 vials of hydrating fluid (1.2ml)	<100 by 0.1ml when processed according to directions	<ul style="list-style-type: none"> - Growth promotion testing - Media challenge testing - Suitability of counting methods - Suitability of sterility tests - Suitability of tests for specified microorganisms - Microbial limits testing - Microbial enumeration testing - Validation of neutralization methods - Methods requiring a low CFU concentration
MiStraCon®QuantyE-Pellets	1 vial of lyophilized pellets in a plastic bag with hermetic seal	1 vial with 5 pellets	1.0E+03 – 1.0E+07 per pellet	<ul style="list-style-type: none"> - Detection and enumeration methods - Verification/Validation - Bioburden determination - Minimal lethal concentration - Disinfectant qualification - Water tests - Proficiency tests - Methods requiring a specific CFU range

MiStraCon® Swabs2



Applications

- Culture Purposes
- Daily QC
- Verification and Validation
- QC of Identification Systems and Assay Kits
- QC of Antimicrobial Susceptibility Test

Highlights

- 26 strains available
- All-in-one design reduces the risk of contamination
- Ready-to-use format saves you time and money
- Refrigerated storage is easy and economical
- Online Certificate of Analysis provides detailed strain information
- Traceability to reference cultures ensures authenticity
- Technical Support experts available for guidance

Package Details

- User-friendly design with a lyophilized microorganism pellet, ampoule of hydrating fluid and inoculating swab
- Packs of 2 units
- Illustrated instructions

Illustrated Instructions

Each MiStraCon® Swabs2 kit consists of 2 individually packaged swabs. Each MiStraCon® Swabs2 unit contains a lyophilized pellet of a single microorganism strain, a reservoir of hydrating fluid and an inoculating swab. Each swab is sealed within a laminated pouch that contains a desiccant to prevent adverse moisture accumulation.

- 1: Allow unopened MiStraCon® Swabs2 to equilibrate to room temperature.
- 2: Break red snap valve to release the hydrating fluid.
- 3: Squeeze the bulb at the top of the MiStraCon® Swabs2 to rehydrate the pellet.
- 4: Inoculate a primary culture plate(s).
- 5/6/7: Continue according to laboratory protocol. Discard the MiStraCon® Swabs2 properly. Incubate the inoculated primary culture plate(s) under appropriate conditions.



PRESENTATION	DESCRIPTION	PACKAGING	ART. NO.
<i>Aspergillus brasiliensis</i> ATCC® 16404™ / WDCM 00053	Contains two swabs	2	S00001-MSC
<i>Pseudomonas aeruginosa</i> ATCC® 9027™ / WDCM 00026	Contains two swabs	2	S00002-MSC
<i>Staphylococcus aureus subsp. aureus</i> ATCC® 6538™ / WDCM 00032	Contains two swabs	2	S00003-MSC
<i>Escherichia coli</i> ATCC® 8739™ / WDCM 00012	Contains two swabs	2	S00004-MSC
<i>Candida albicans</i> ATCC® 10231™ / WDCM 00054	Contains two swabs	2	S00005-MSC
<i>Bacillus subtilis subsp. spizizenii</i> ATCC® 6633™ / WDCM 00003	Contains two swabs	2	S00006-MSC
<i>Clostridium perfringens</i> ATCC® 13124™ / WDCM 00007	Contains two swabs	2	S00007-MSC
<i>Enterococcus faecalis</i> ATCC® 29212™ / WDCM 00087	Contains two swabs	2	S00008-MSC
<i>Escherichia coli</i> ATCC® 25922™ / WDCM 00013	Contains two swabs	2	S00009-MSC
<i>Salmonella enterica serovar typhimurium</i> ATCC® 14028™ / WDCM 00031	Contains two swabs	2	S00010-MSC
<i>Clostridium sporogenes</i> ATCC® 19404™ / WDCM 00008	Contains two swabs	2	S00011-MSC
<i>Burkholderia cepacea</i> ATCC® 25416™	Contains two swabs	2	S00012-MSC
<i>Staphylococcus epidermidis</i> ATCC® 12228™ / WDCM 00036	Contains two swabs	2	S00014-MSC
<i>Bacillus cereus</i> ATCC® 11778™ / WDCM 00001	Contains two swabs	2	S00015-MSC
<i>Enterobacter aerogenes</i> ATCC® 13048™ / WDCM 00175	Contains two swabs	2	S00016-MSC
<i>Legionella p. sub.pneumophila</i> ATCC® 33152™ / WDCM 00107	Contains two swabs	2	S00017-MSC
<i>Campylobacter jejuni subsp. jejuni</i> ATCC® 33291™ / WDCM 00005	Contains two swabs	2	S00018-MSC
<i>Listeria innocua</i> ATCC® 33090™ / WDCM 00017	Contains two swabs	2	S00019-MSC
<i>Listeria monocytogenes</i> ATCC® 13932™ / WDCM 00021	Contains two swabs	2	S00020-MSC
<i>Proteus mirabilis</i> ATCC® 29906™ / WDCM 00023	Contains two swabs	2	S00021-MSC
<i>Saccharomyces cerevisiae</i> ATCC® 9763™ / WDCM 00058	Contains two swabs	2	S00022-MSC
<i>Citrobacter freundii</i> ATCC® 43864™ / WDCM 00006	Contains two swabs	2	S00023-MSC
<i>Salmonella abony</i> NCTC® 6017™	Contains two swabs	2	S00024-MSC
<i>Lactobacillus acidophilus</i> ATCC® 4356™ / WDCM 00098	Contains two swabs	2	S00025-MSC
<i>Legionella anisa</i> ATCC® 35292™ / WDCM 00106	Contains two swabs	2	S00026-MSC
<i>Lactobacillus sakei subsp. sakei</i> ATCC® 15521™ / WDCM 00015	Contains two swabs	2	S00027-MSC



MiStraCon® QuantyE-Pellets



Applications

- Detection and enumeration methods
- Verification/Validation
- Bioburden determination
- Minimal lethal concentration
- Disinfectant qualification
- Water tests
- Proficiency tests
- Methods requiring a specific CFU range

Highlights

- Available in concentrations ranging from 10³ to 10⁷ CFU per pellet
- Can be combined for a mixed microorganism population
- Easily manipulated to deliver a wide variety of concentrations
- Ready-to-use format saves you time and money
- Refrigerated storage is easy and economical
- Online Certificate of Analysis provides detailed strain information
- Traceability to reference cultures ensures authenticity
- Technical support experts available for guidance

Package Details

- Vial with 5 quantified lyophilized pellets
- Illustrated instructions

Illustrated Instructions

MiStraCon® QuantyE-Pellets include: 1 vial of a single enumerated microorganism (5 lyophilized pellets per vial) and a card with illustrated instructions.

If using the Membrane Filtration Method for water testing, please refer to the Illustrated Instructions (Membrane Filtration for MiStraCon® QuantyE-Pellets) located on our website at www.scharlab.com.

- 1: Remove the vial of pellets from refrigerated storage and allow to equilibrate to room temperature.
- 2: Prior to use, warm hydrating and dilution fluids to 34-38°C. Sterile pH 7.2 phosphate buffer is recommended for hydration of the lyophilized preparation.
- 3: With sterile forceps, transfer the microorganism pellet(s) to the hydrating fluid. Do not remove the desiccant from vial. Immediately stopper and recap the vial and return to 2-8°C.
- 4: Place the microorganism suspension into a 34-38°C incubator for 30 minutes to assure complete hydration.
- 5/6: Immediately following incubation, mix hydrated material until a homogeneous suspension is achieved. Primary culture plate(s) under appropriate conditions. Proceed with the challenge according to laboratory protocol. The challenge must be completed within 30 minutes of the hydration process to avoid a change in the challenge suspension concentration.



PRESENTATION	DESCRIPTION	PACKAGING	ART. NO.
<i>Aspergillus brasiliensis</i> ATCC® 16404™/ WDCM 00053	Contains one vial with 5 pellets (E6 CFU/pellet)	1 vial	EP2001-MSC
<i>Pseudomonas aeruginosa</i> ATCC® 9027™/ WDCM 00026	Contains one vial with 5 pellets (E7 CFU/pellet)	1 vial	EP2002-MSC
<i>Staphylococcus aureus subsp. aureus</i> ATCC® 6538™/ WDCM 00032	Contains one vial with 5 pellets (E7 CFU/pellet)	1 vial	EP2003-MSC
<i>Escherichia coli</i> ATCC® 8739™/ WDCM 00012	Contains one vial with 5 pellets (E7 CFU/pellet)	1 vial	EP2004-MSC
<i>Candida albicans</i> ATCC® 10231™/ WDCM 00054	Contains one vial with 5 pellets (E7 CFU/pellet)	1 vial	EP2005-MSC
<i>Bacillus subtilis subsp. spizizenii</i> ATCC® 6633™/ WDCM 00003	Contains one vial with 5 pellets (E6 CFU/pellet)	1 vial	EP2006-MSC
<i>Enterococcus faecalis</i> ATCC® 29212™/ WDCM 00087	Contains one vial with 5 pellets (E7 CFU/pellet)	1 vial	EP2008-MSC
<i>Salmonella enterica serovar typhimurium</i> ATCC® 14028™/ WDCM 00031	Contains one vial with 5 pellets (E4 CFU/pellet)	1 vial	EP2010-MSC
<i>Burkholderia cepacea</i> ATCC® 25416™	Contains one vial with 5 pellets (E7 CFU/pellet)	1 vial	EP2012-MSC



MiStraCon® QuantyPellets



Applications

- Growth Promotion Testing
- Media Challenge Testing
- Suitability of Counting Methods
- Suitability of Sterility Tests
- Suitability of Tests for Specified Microorganisms
- Microbial Limits Testing
- Microbial Enumeration Testing
- Validation of Neutralization Methods
- Methods requiring a low CFU concentration

Highlights

- Delivers 10-100 CFU per 0.1 ml as required by USP/Ph. Eur./JP
- Instant dissolve pellet reduces preparation time
- No dilutions required for simplified test procedure
- Up to 8 hours stability allows for ultimate flexibility
- 50 tests per kit, ideal quantity for labs of any size
- Refrigerated storage is easy and economical
- Online Certificate of Analysis provides detailed strain information
- Authentic, traceable strains at four passages (or fewer) from reference culture - meets USP/Ph. Eur./JP requirements
- Technical Support experts available for guidance

Package Details

- 5 foil pouch with 1 vial of a single, quantified microorganism (1 lyophilized pellet per vial)
- 5 vials of hydrating fluid (1.2 ml in each vial)
- Up to 50 tests per kit
- Illustrated instructions

Illustrated Instructions

Each MiStraCon® QuantyPellets kit consists of:

- 5 vials each containing 1 lyophilized pellet of an individual microorganism strain.
- 5 hydrating fluid vials each containing 1.2 ml of hydrating fluid.

- 1: Allow to equilibrate to room temperature (about 30 minutes) 1 vial of hydrating fluid and 1 foil pouch containing lyophilized pellet.
- 2: Tear open the foil pouch and remove the vial containing 1 lyophilized pellet.
- 3: Tip 1 pellet into the 1.2 ml vial of hydrating fluid. Only 1 pellet must be used to obtain the challenge concentration of 10-100 CFU per 0.1 ml on non-selective media. Immediately recap hydrating fluid vial.
- 4: Vortex hydrated material until pellet has completely dissolved and suspension is homogeneous.
- 5: Transfer 0.1 ml of the hydrated suspension to the material being challenged (0.1 ml contains 10-100 CFU). Remaining suspension can be refrigerated and used for up to 8 hours. Test suspension immediately after removing it from refrigerator.

Proceed according to laboratory protocol. Refrigerate suspension at 2-8°C if it will be used again. Discard in accordance with the laboratory protocol for disposal of biohazard materials.



PRESENTATION	DESCRIPTION	PACKAGING	ART. NO.
Aspergillus brasiliensis ATCC® 16404™/ WDCM 00053	Contains 5 pellets individualized in aluminized envelope and 5 vials of hydrating liquid. (10-100 CFU/0,1 ml)	5 sachets + 5 vials	P10001-MSC
Pseudomonas aeruginosa ATCC® 9027™/ WDCM 00026	Contains 5 pellets individualized in aluminized envelope and 5 vials of hydrating liquid. (10-100 CFU/0,1 ml)	5 sachets + 5 vials	P10002-MSC
Staphylococcus aureus subsp. aureus ATCC® 6538™/ WDCM 00032	Contains 5 pellets individualized in aluminized envelope and 5 vials of hydrating liquid. (10-100 CFU/0,1 ml)	5 sachets + 5 vials	P10003-MSC
Escherichia coli ATCC® 8739™/ WDCM 00012	Contains 5 pellets individualized in aluminized envelope and 5 vials of hydrating liquid. (10-100 CFU/0,1 ml)	5 sachets + 5 vials	P10004-MSC
Candida albicans ATCC® 10231™/ WDCM 00054	Contains 5 pellets individualized in aluminized envelope and 5 vials of hydrating liquid. (10-100 CFU/0,1 ml)	5 sachets + 5 vials	P10005-MSC
Bacillus subtilis subsp. spizizenii ATCC® 6633™/ WDCM 00003	Contains 5 pellets individualized in aluminized envelope and 5 vials of hydrating liquid. (10-100 CFU/0,1 ml)	5 sachets + 5 vials	P10006-MSC
Salmonella enterica serovar typhimurium ATCC® 14028™/ WDCM 00031	Contains 5 pellets individualized in aluminized envelope and 5 vials of hydrating liquid. (10-100 CFU/0,1 ml)	5 sachets + 5 vials	P10010-MSC
Clostridium sporogenes ATCC® 19404™/ WDCM 00008	Contains 5 pellets individualized in aluminized envelope and 5 vials of hydrating liquid. (10-100 CFU/0,1 ml)	5 sachets + 5 vials	P10011-MSC

REAGENTS FOR MICROBIOLOGICAL APPLICATIONS

REAGENTS FOR BIOCHEMICAL TESTS PAGE 156

REAGENTS FOR MOLECULAR BIOLOGY PAGE 158

OTHER REAGENTS PAGE 160

REAGENTS FOR BIOCHEMICAL TESTS

ACID ALCOHOL DECOLORIZER

Decolourizer used in the bacterial AAR staining.

DESCRIPTION	PRESENTATION	TYPE OF PACKAGING	ART. NO.
Acid Alcohol Decolorizer	1 flask with 1 l	Ⓢ	064CL00081

ACID PHOSPHATASE REAGENT

Reactive acid phosphatase is used according to the ISO 14189 standard for the detection of acid phosphatase from *Clostridium perfringens*.

DESCRIPTION	PRESENTATION	TYPE OF PACKAGING	ART. NO.
Acid Phosphatase Reagent	1 vial of 10 ml of sodium acetate buffer + 6 vials with 0.6 g of dye reagent	Ⓢ	0000TN1519

CATALASE ACTIVITY TEST

For detection of catalase enzyme activity.

DESCRIPTION	PRESENTATION	TYPE OF PACKAGING	ART. NO.
Hydrogen peroxide 3% (w/v)	1 flask with 30 ml	Ⓢ	064-CL0234
Hydrogen Peroxide 30% (v/v) extremely pure	1 flask with 1 l	Ⓢ	H101351000

COAGULASE TEST (RABBIT PLASMA)

Sterile and lyophilized rabbit plasma, particularly suitable for detecting coagulase of *Staphylococcus aureus*. According to ISO 6888-1.

DESCRIPTION	PRESENTATION	TYPE OF PACKAGING	ART. NO.
Lyophilized rabbit plasma (20 tests)	1 tube with 9 ml of plasma + 1 vial of sterile water	Ⓢ	064-PLA-CO

CRYSTAL VIOLET GRAM

Staining solution in Gram Staining.

DESCRIPTION	PRESENTATION	TYPE OF PACKAGING	ART. NO.
Crystal Violet	1 flask with 25 g	Ⓢ	V100250025
Decolorizer Gram	1 flask with 1 l	Ⓢ	064CL00021
Oxalate Crystal Violet	1 flask with 100 ml	Ⓢ	V10027G100
Reagent Crystal Violet	1 flask with 1 l	Ⓢ	064CL00061

DNASE ACTIVITY TEST

For detection of DNase enzyme activity (presence of bacterial nucleases that depolymerise DNA).

DESCRIPTION	PRESENTATION	TYPE OF PACKAGING	ART. NO.
Hydrochloric Acid 0.1N, Sol. valorated 1 l	1 flask with 1 l	⊕	AC07461000

β-GLUCORONIDASE BROTH

β-glucuronidase Broth for the identification of Enterobacteria.

DESCRIPTION	PRESENTATION	TYPE OF PACKAGING	ART. NO.
β-Glucuronidase broth	20 tubes with 2 ml	↓	064-TA0153

HIPPURATE TEST

For the differentiation between group B streptococcus and other β-hemolytic streptococcus by the hippurate hydrolysis test. A suspension of bacteria is added to the hippurate solution and incubated for 2 hours. Then, the ninhydrin developer is added.

DESCRIPTION	PRESENTATION	TYPE OF PACKAGING	ART. NO.
Hippurate Test	20 tubes with 2 ml	↓	064-TA0114
Ninhydrin Developer	2 tubes with 5 ml	↓	230-070491

INDOL TEST AND KOVAC'S REAGENT

Tryptone water supplemented with tryptophan. For the detection of indole production from tryptophan. The reading is done with the Kovac's Reagent.

DESCRIPTION	PRESENTATION	TYPE OF PACKAGING	ART. NO.
Indolite test	20 tubes with 2 ml	↓	064-TA0132
Kovac's reagent	1 flask with 100 ml	⊖	RE0007G100
Kovacs' reagent	1 flask with 1 l	⊕	RE00071000

LUGOL SOLUTION FOR GRAM

Reagent for stain micro organismes according to Gram Method.

DESCRIPTION	PRESENTATION	TYPE OF PACKAGING	ART. NO.
Lugol solution	1 flask with 1 l	⊕	064CL00101

METHYL RED TEST

Indicator solution to test for fermentation of glucose via the mixed-acid pathway in Enterobacteria.

DESCRIPTION	PRESENTATION	TYPE OF PACKAGING	ART. NO.
Methyl Red Solution 2%	1 flask with 100 ml	⊖	RE0057G100
Methyl Red Solution 2%	1 flask with 1 l	⊕	RE00571000

METHYLENE BLUE SOLUTION

Methylene Blue Solution is used as contrast stain in the bacterial AAR staining.

DESCRIPTION	PRESENTATION	TYPE OF PACKAGING	ART. NO.
Methylene Blue dye	1 flask with 1 l	⊕	064CL00121

NESSLER, REAGENT

Reagent to detect the production of ammonia from a peptone or arginine.

DESCRIPTION	PRESENTATION	TYPE OF PACKAGING	ART. NO.
Nessler Reagent	1 flask with 250 ml	⊕	RE00500250

ONPG-FDA-MUG-INDOL TEST

Broth for the simultaneous detection of total coliform and *E. coli* in water and food. This detection has been enhanced with chromogenic and fluorogenic substrates: ONPG test (detection of β-galactosidase activity), phenylalanine, MUG (fluorescence of *E. coli*) and indol (adding Kovac's reagent), for the identification of Enterobacteria and to verify FDA test means adding a solution of FeCl 10%.

DESCRIPTION	PRESENTATION	TYPE OF PACKAGING	ART. NO.
Kovacs Reagent	1 flask with 100 ml	⊖	RE0007G100
ONPG-FDA-MUG-INDOL Test	20 tubes with 2 ml	↓	064-TA0203

ORNITHINE TEST

Medium for detecting the decarboxylation of ornithine.

DESCRIPTION	PRESENTATION	TYPE OF PACKAGING	ART. NO.
Ornithine Test	20 tubes with 2 ml	↓	064-TA0131

OXIDASE TEST

Medium for detecting the decarboxylation of ornithine.

DESCRIPTION	PRESENTATION	TYPE OF PACKAGING	ART. NO.
Oxidase Reagent	5 g	⊘	RE00650005
Oxidase reagent in swabs	50 swabs	–	06-120-050

PHENICATED FUCHSIN ZIEHL-NEELSEN

Counterstain used in bacteriological stains.

DESCRIPTION	PRESENTATION	TYPE OF PACKAGING	ART. NO.
Fucsina GRAM	1 flask with 1 litre	⊘	00CL0004-1
Phenicated fuchsin	1 flask with 1 litre	⊘	064CL00111

VOGES PROSKAUER TEST

Reagents for Voges Proskauer test in Enterobacteria.

DESCRIPTION	PRESENTATION	TYPE OF PACKAGING	ART. NO.
Barrit Reagent (Alpha-Naphtol)	1 flask with 100 ml	⊘	RE0100G100
O'Meara Reagent	1 flask with 100 ml	⊘	RE0060G100

REAGENTS FOR MOLECULAR BIOLOGY

All of our products for molecular biology are manufactured according to the ISO 9002 quality certification and undergo strict quality controls to guarantee its suitability for molecular biology applications. We pay special attention to purity, low UV rays absorption and the absence of enzymes that can damage nucleic acids or proteins (DNase, RNase, proteases).

BIOLOGICAL BUFFERS

ART. NO.	DESCRIPTION	PRESENTATION
HE0100	HEPES, free acid, molecular biology grade	25 g / 250 g
HE0011	HEPES, sodium salt, molecular biology grade	25 g / 250 g
MO0070	MOPS, molecular biology grade	100 g / 500 g
PI0061	PIPES, free acid, molecular biology grade	25 g / 250 g / 1 kg
TA0010	TAE 10X buffer, molecular biology grade	1 l / 10 l
TB0010	TBE 5X buffer, molecular biology grade	1 l / 10 l
TR0424	TRIS base, molecular biology grade	100 g / 500 g / 1 kg / 5 kg
TR0425	TRIS-HCl, molecular biology grade	100 g / 1 kg / 5 kg
TR0422	TRIS, extra pure	250 g / 1 kg / 5 kg

CLONING. ANTIBIOTICS

ART. NO.	DESCRIPTION	PRESENTATION
AM0468	Ampicillin, sodium salt, biochemical purposes	5 g / 25 g
CI0025	Chloramphenicol, biochemical purposes	50 g / 500 g
KA0010	Kanamycin disulphate, molecular biology grade	5 g / 25 g
0B21408-14	Tetracycline hydrochloride, 96%	25 g

CLONING. ENZYME SUBSTRATES

ART. NO.	DESCRIPTION	PRESENTATION
IP0010	IPTG, molecular biology grade (dioxane free)	1 g

DNA / RNA EXTRACTION

ART. NO.	DESCRIPTION	PRESENTATION
CE0121	Cesium chloride, molecular biology grade	100 g / 500 g
FE0484	Phenol cryst., molecular biology grade	100 g / 500 g
GU0061	Guanidine hydrochloride, molecular biology grade	100 g / 1 kg
GU0065	Guanidine thiocyanate, molecular biology grade	250 g
LI0112	Lithium chloride, molecular biology grade	50 g / 250 g
SA0020	Sucrose, extra pure	500 g / 1 kg / 5 kg
SU0030	Sucrose, molecular biology grade	1 kg / 5 kg

ELECTROPHORESIS. AGAROSE AND ACRYLAMIDE

ART. NO.	DESCRIPTION	PRESENTATION
AC3345	Acrylamide, electrophoresis grade	100 g / 1 kg
AG0032	Agarose High EEO	25 g / 100 g / 250 g
AG0036	Agarose high resolution	25 g
AG0030	Agarose Low EEO	25 g / 100 g / 250 g / 1 kg
AG0031	Agarose Medium EEO	25 g / 100 g / 250 g / 1 kg
AG0034	Agarose Low Melt	5 g / 25 g
BIO091	n,n'-Methylene-bis-acrylamide, electrophoresis grade	50 g
BIO090	n,n'-Methylene-bis-acrylamide, molecular biology grade	25 g

ELECTROPHORESIS. REAGENTS FOR ELECTROPHORESIS

ART. NO.	DESCRIPTION	PRESENTATION
AM0371	Ammonium persulphate, molecular biology grade	25 g / 100 g
AC0402	Glycine, extra pure	250 g / 1 kg / 5 kg
AC0406	Glycine, molecular biology grade	100 g / 1 kg
TE0050	TEMED, r.g.	10 ml / 100 ml
UR0133	Urea, molecular biology grade	100 g / 500 g / 2.5 kg

ELECTROPHORESIS. DYES

ART. NO.	DESCRIPTION	PRESENTATION
ET0108	Ethidium bromide, biochemical purposes	1 g / 10 g
ET0109	Ethidium bromide, solution 10 mg/ml	10 ml / 250 ml

ELECTROPHORESIS. BUFFERS FOR ELECTROPHORESIS

ART. NO.	DESCRIPTION	PRESENTATION
TA0010	TAE 10X buffer, molecular biology grade	1 l / 10 l
TB0010	TBE 5X buffer, molecular biology grade	1 l / 10 l

HYBRIDIZATION. BUFFERS FOR HIBRIDIZATION

ART. NO.	DESCRIPTION	PRESENTATION
AM0271	Ammonium acetate, molecular biology grade	250 g / 500 g
AM0274	Ammonium chloride, molecular biology grade	500 g
AM0401	Ammonium sulphate, molecular biology grade	100 g / 1 kg
SD0010	SDS, molecular biology grade	50 g / 500 g

HYBRIDIZATION. REAGENTS FOR HIBRIDIZATION

ART. NO.	DESCRIPTION	PRESENTATION
F00026	Formamide, r.g.	1 l / 2.5 l
F00027	Formamide deionized, molecular biology grade	100 ml

OTHER REAGENTS

OTHER REAGENTS

ART. NO.	DESCRIPTION	PRESENTATION
AC0580	Boric acid, molecular biology grade	500 g / 1 kg / 5 kg
CA0198	Calcium chloride 2 hydrate, molecular biology grade	250 g / 1 kg
DI1360	1,4-Dithiotreitol, molecular biology grade	1 g / 10 g
AC0965	EDTA, disodium salt 2 hydrate, r.g.	250 g / 500 g / 1 kg / 5 kg
AC0967	EDTA, disodium salt, molecular biology grade	100 g / 1 kg / 5 kg
ET0011	Ethanol, DNase free	500 ml / 1 l / 2.5 l
F00012	Formaldehyde, sol 37%, molecular biology grade	250 ml / 1 l
F00011	Formaldehyde, sol 37%, r.g.	1 l / 2.5 l / 5 l / 25 l
GL0028	Glycerol anhydrous, molecular biology grade	100 ml / 1 l
MA0037	Magnesium chloride 6 hydrate, molecular biology grade	100 g / 500 g
MA0086	Magnesium sulphate 7 hydrate, molecular biology grade	100 g / 500 g
ME0095	2-Mercaptoethanol, molecular biology grade	50 ml / 250 ml
P00066	Polyethylene glycol 6000, molecular biology grade	100 g / 1 kg
P00080	Polyvinylpyrrolidone, molecular biology grade	100 g / 1 kg
P00112	Potassium acetate, molecular biology grade	250 g / 1 kg
P00201	Potassium chloride, molecular biology grade	250 g / 1 kg
P00262	Potassium di-hydrogen phosphate, molecular biology grade	100 g / 1 kg
S00036	Sodium acetate anhydrous, molecular biology grade	500 g / 1 kg / 5 kg
S00230	Sodium chloride, molecular biology grade	500 g / 1 kg / 5 kg
S00328	Sodium di-hydrogen phosphate 1 hydrate, molecular biology grade	250 g / 1 kg / 5 kg
S00329	di-Sodium hydrogenophosphate anhydrous, molecular biology grade	250 g / 500 g / 1 kg / 5 kg
S00205	tri-Sodium citrate dihydrate, molecular biology grade	1 kg / 5 kg
TW0022	Tween 20, molecular biology grade	100 ml
CI0155	Zinc chloride, molecular biology grade	50 g

DETERLABO®

Laboratory glassware, utensils and surface cleaning



Scharlab
The wise choice





NEW CATALOGUE

Chemicals and Reagents

Chemicals,
Organic Standards,
Chromatography,
Glassware
and Consumables

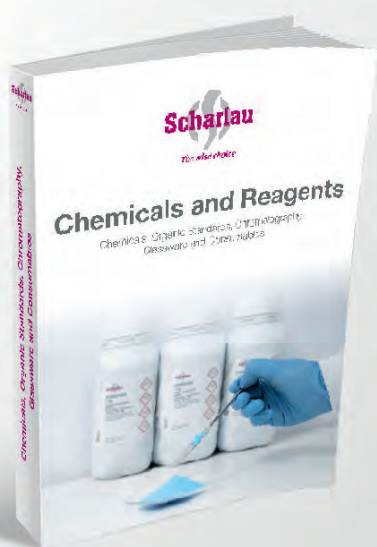

GLASSWARE

INTRODUCTION

SCHARLAU GLASSWARE	164
SCHARLAU GLASSWARE SERVICES	166
SCHARLAU VOLUMETRIC GLASSWARE	167
MARKING OF OUR VOLUMETRIC INSTRUMENTS	170
SCHARLAU MOULDED GLASSWARE	172
SCHARLAU GROUND JOINT GLASSWARE	173
CUSTOM-MADE GLASSWARE	174
OUR PACKAGING	176
SAFE HANDLING OF GLASSWARE	177
CLEANING OF GLASSWARE	178
CARE AND HANDLING OF GLASSWARE	179
BEAKERS	180
CONDENSERS	181
FILTRATION	184
FLASKS	185
SCHARLAU HEATING BLOCKS	187
FUNNELS	189
GLASSWARE FOR INERT ATMOSPHERE	190
LABORATORY BOTTLES	191
OTHER PRODUCTS	192
PYCNOMETERS	193
SOXHLET EXTRACTORS	194
TUBES	196
VOLUMETRIC MATERIAL	198
WEIGHING ELEMENTS	203
SCHARLAU PREMIUM MINIREACTORS	204

Introduction

Thanks to the acquisition of new space for the extension of our workshop, we at Scharlab have continued improving our production of laboratory glassware and growing even more in export markets. Well-equipped workshops and highly skilled specialists make sure our glassware adheres to high quality standards.

Standard and special glassware

Products for which there is regular demand are produced in larger quantities and then stocked for immediate supply. Other products are either manufactured directly from glass tubing or are made from semi-finished products.

Quality

Even today, scientific glassblowing remains a highly skilled handcraft and the glassware quality depends on the skill of each blower. Careful selection of the raw glass ensures that our final products are free from imperfections such as air lines, scratches and grains. You will be able to judge the workmanship of our glassware products for yourself.

Safety

All our glassware is annealed and made stress free, to prevent it from breaking.



Scharlau, in the scientific
glassware business
for over 30 years

Scharlau glassware is made from Borosilicate 3.3 glass that meets the specifications of the following standards:

BS ISO 3585, DIN 12217	Type 3.3 Borosilicate glass
ASTM E-438	Type 1 Class A Borosilicate glass
US Pharmacopoeia	Type 1 Borosilicate glass
European Pharmacopoeia	Type 1 Glass

The typical chemical composition of our borosilicate glass is the following:

SiO ₂	81 %
B ₂ O ₃	13 %
Na ₂ O	4 %
Al ₂ O ₃	2 %

There are 4 temperatures worth noting:

The working point

The temperature at which glass reaches a viscosity of 104 poise. At this temperature glass is soft enough for most lamp-working or sealing tasks. Borosilicate reaches this state at 1252°C.

The softening point

The temperature at which glass reaches a viscosity of 107.6 poise. Borosilicate reaches this state at 821°C.

The annealing point

The temperature at which the internal stress caused by rapid cooling (within 15min) from working-point temperatures is safely relieved. Borosilicate reaches this state at 565°C.

The strain point

The temperature at which the internal stress in a glass is substantially relieved only after several hours. Borosilicate reaches this state at 510°C.

Chemical resistance

Borosilicate glass is resistant to water, acids, halogens and organic solvents.

It has moderate resistance to alkaline solutions and is not resistant to hydrofluoric acid, hot concentrated phosphoric acid nor strong alkaline solutions.

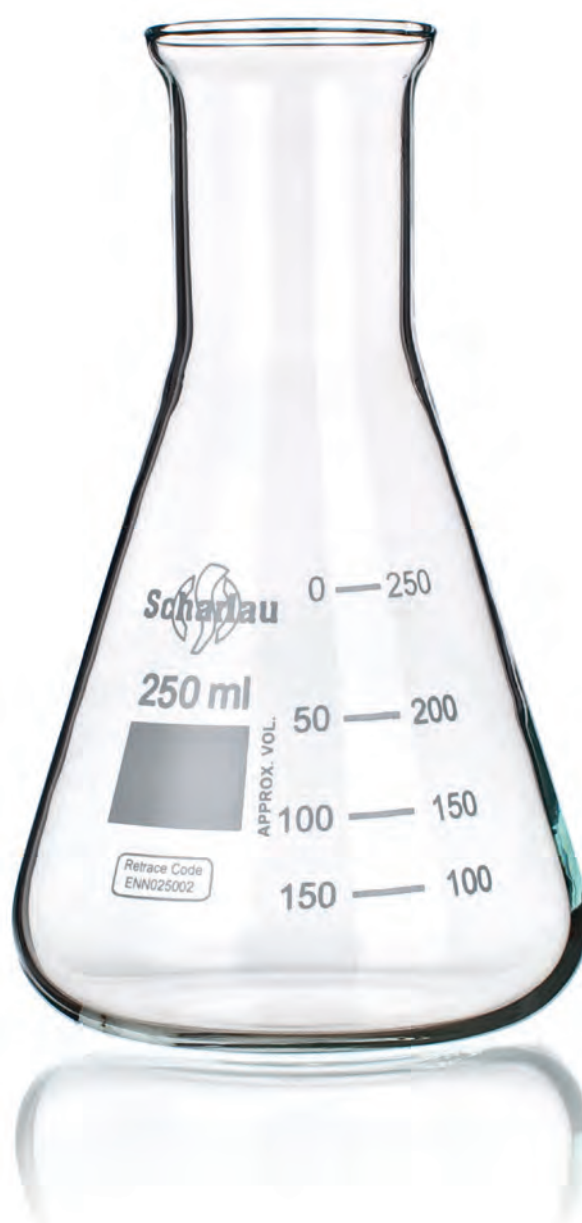

SCHARLAU GLASSWARE SERVICES

Scharlab glassware services

Scharlab offers to our customers the following services:

- **In house Calibration of volumetric material according to ISO 17025:2017** by our accredited calibration laboratory.
- Supply and **colouring in amber** of glassware for light sensitive products. Unlike transparent glass, the transmission of amber glass is less than 10% within the wavelength range between 300-500 nm.
- **Acid etching** for all types of pieces. It makes the volumetric graduation of the pieces last forever. This technique is very useful for petrochemical industries, where petroleum derivatives are very aggressive with silkscreen printing on glass.

- **Polymer coating** for laboratory bottles in order to prevent spillage in case of glassware breakage. This also prevents the loss of content inside the bottle.
- **Manufacture under ISO, ASTM, etc rules.** Our experience and knowledge are made available for the manufacture of parts in line with all kinds of regulations.
- Possibility to **manufacture quartz pieces.** Quartz resists working temperatures up to 1000°C.
- **Use of high-quality compounds.** We work with Duran® borosilicate 3.3 glass, and we can also work with PTFE, stainless steel or Hastelloy®, very chemical resistant compounds.

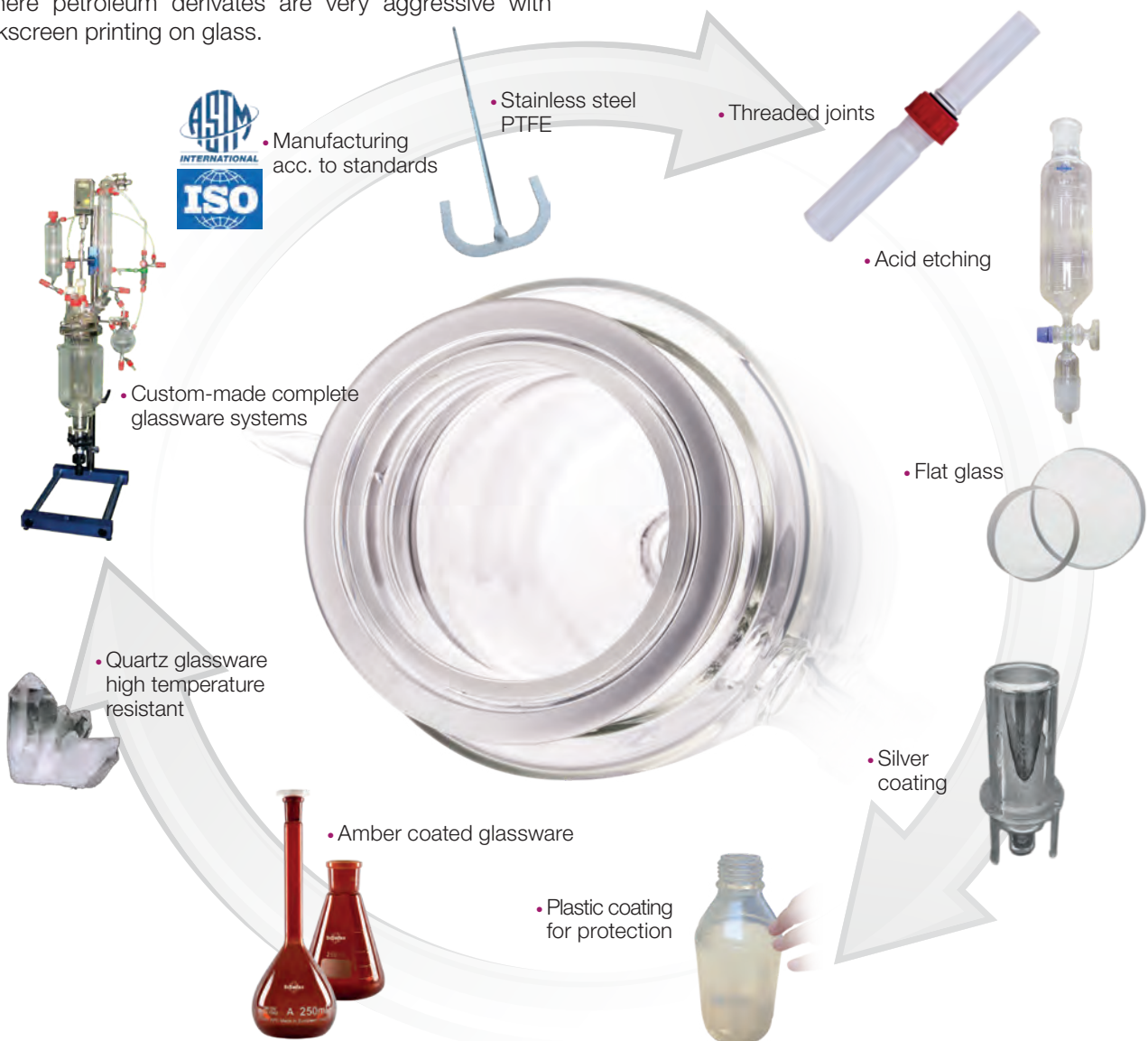

Classification according to the precision

Class A and AS volumetric instruments have identical error limits as established by DIN EN ISO. For class AS volumetric instruments, calibrated to deliver (TD, Ex), the additional 'S' means swift delivery.

Delivery time

The delivery time is defined as the period of time required for the free fall of the meniscus (discharge of water due to gravity) from the upper volume mark to reach the lower volume mark or the tip. This is related to the defined waiting time for class AS volumetric instruments. In class AS pipettes the delivery time is much faster than in class A pipettes (see example below).

Waiting time

The waiting time is the time taken from when the meniscus comes to rest at the lower volume mark or in the tip, until the residual liquid has finished flowing down from the glass wall of the pipette into the vessel.

Waiting time for class AS: The waiting time for class AS bulb and graduated pipettes is 5 s which is indicated on the pipette by the manufacturer. The pipette should not be removed from the receiving vessel until this time has elapsed starting from when the meniscus comes to rest in the tip/lower volume mark.

Class A pipettes have no waiting time and thus compensate for the slower delivery time.

The following are delivery and waiting times for different classes of 25 ml bulb pipettes:

Class A	Class AS
Delivery time: 25–50 s	Delivery time: 15-20 s
Waiting time: 0	Waiting time: 5 s

Certificate of performance

Our volumetric instruments are calibrated in an accredited laboratory according to ISO 17025:2017 for the calibrating of volumetric instruments. Our range of calibration for volumetric instruments is:

- Volumetric flasks from 5 ml up to 21 l, both transparent and amber ones
- Volumetric cylinders from 5 ml up to 5 l with stopper or spout
- Volumetric pipettes from 1 ml up to 100 ml of one and two marks
- Graduated pipettes from 1 ml up to 25 ml
- Burettes from 1 ml up to 100 ml, with glass or PTFE stopcocks

All of our AS & A class volumetric glassware material comes with a performance certificate in the packaging. It is a batch certificate, and each piece has the batch number printed. A certificate is emitted for each batch, and contains, among others, the "mean value" and the "standard deviation".

Quality

Quality assurance is based on compliance with European (EN) and international (ISO) standards. Statistical Process Control (SPC) helps us obtain the smallest possible deviation from the nominal value (precision) and, at the same time, the minimum dispersion of the individual results (coefficient of variation).

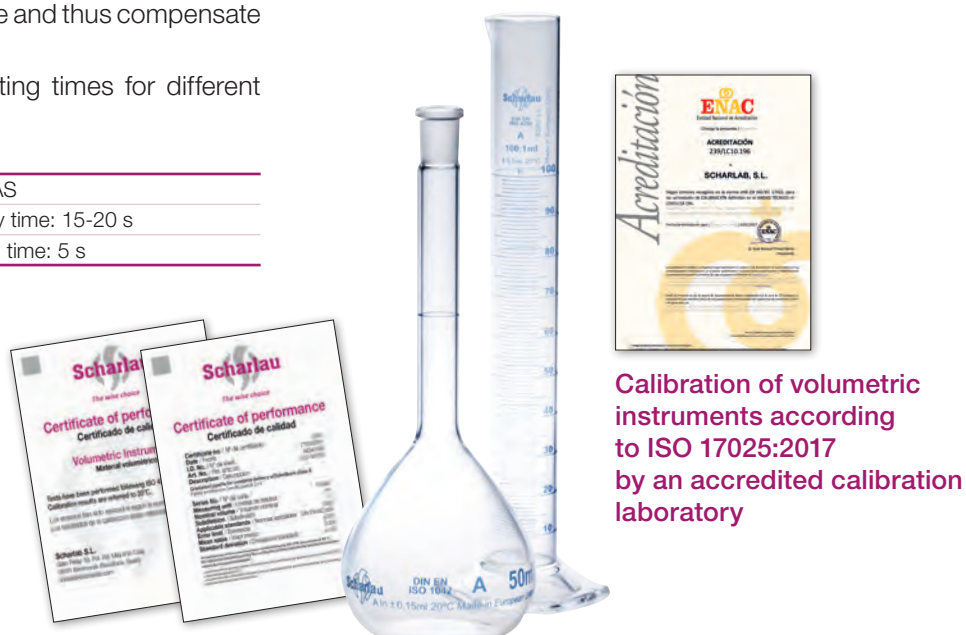

Calibration of volumetric instruments according to ISO 17025:2017 by an accredited calibration laboratory



Download this brochure



Volumetric flasks with coloured neck

The neck colours offer a wide range of possibilities. They can be used for the identification and separation of different API's in the pharma industry as well as for the usage of different groups in a shared lab. The flasks are available in four colours: blue, red, green and yellow. Other colours are available on request.

Several players-different colours

Important information about volumetric glassware

Volumetric glassware is not designed to be heated; however, the following must be taken into account:

- To ensure a long life for the volumetric glass and prevent possible changes in volume, these products should not be heated above 180°C in drying stoves or in autoclaves.
- Never heat the volumetric glass on a heating plate.
- Whenever the volumetric glass has to be heated or cooled, it should be done gradually and not suddenly, to prevent possible glass breakage.
- The batch certificates of the volumetric glass are based on a reference temperature of 20°C.

Tips and precautions for cleaning of volumetric glassware

Tips

- With volumetric glassware, we have to ensure reproducibility. This is why perfect wetting has to be achieved in order not to distort the meniscus and not to affect the volume of liquid of any volumetric glassware calibrated to deliver.
- Therefore, cleaning has to be done in such a way as to eliminate organic substances, especially grease, that may not allow a uniform wetting with distilled water.
- After the washing process, glassware must be rinsed thoroughly with distilled water.
- If glassware is to be dried, as is the case with all flasks marked “to contain”, ethanol or acetone can be used for rinsing.
- The drying process may be shortened by passing dry air through it. To ensure that the air is really clean and free from oil, the air compressor must be equipped with appropriate filters.

Precautions

- Never try to remove any dirt by applying direct heat. This may cause the calibration of the volumetric glassware to be altered.
- Use no abrasives on volumetric glassware, as the scratches may become a place where dirt is deposited, or they may prevent correct drainage of liquid.
- Use manual pipetting aids, but never your mouth, to fill containers with the cleaning solution.
- Graduated lines in blue or white colour which have been fused onto the glass are quite resistant to alkalis and acids but are not as resistant as the glassware itself. Therefore, avoid immersion in such solutions for a prolonged time.
- Pipette graduations coloured amber are as chemically-resistant as the glassware itself, since in this case the glassware has been stained with the colour.

MARKING OF OUR VOLUMETRIC INSTRUMENTS



Scharlab
DIN EN ISO 835
AS
10
±0,05
ml
AS Ex + 5s 20°C Made in European Union
000000

- Brand name
- ISO compliance
- Class (A, AS or B)
- Nominal volume
- Error limit
- Volume unit
- Reference temperature
- Waiting time
- Calibration type
- Batch number

Scharlab
DIN EN ISO 648
AS
1
±0,008
ml
AS Ex + 5s 20°C Made in European Union
000000

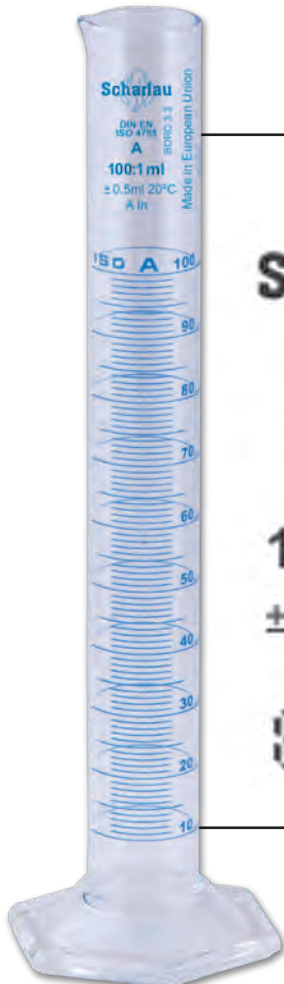

Scharlab
DIN EN ISO 4788
A
100:1 ml
±0,5ml 20°C
A In
BORO 3.3
Made in European Union
000000

- Brand name
- ISO compliance
- Class (A or B)
- Nominal volume
- Volume unit
- Error limit
- Reference temperature
- Calibration type
- Batch number



SCHARLAU MOULDED GLASSWARE

Moulded glassware

In order to meet the growing demands and standards in terms of quality assurance, all of our ISO bottles, beakers and Scharlau brand Erlenmeyer flasks incorporate a retrace code. This nine-digit identification code allows traceability of these products back to the moment of their manufacture and the corresponding batch, which is very important in the medical, pharmaceutical and food industries, where packaging traceability is mandatory. For greater ease, these products also incorporate a graduated double scale to indicate the approximate content.



SCHARLAU GROUND JOINT GLASSWARE

Ground joint glassware

For the manufacture of our material, we use highly transparent and bubble free Borosilicate 3.3 tubing in order to obtain excellent end products. We carry a vast stock of both prefabricated and finished products for immediate delivery. The glass tubing is then manipulated by highly qualified glassblowers according to international standards.

Some of our products are:

- Columns
- Funnels
- Filtration system
- Pycnometers
- Flasks
- Reactors



SCHARLAU
CUSTOM-MADE GLASSWARE

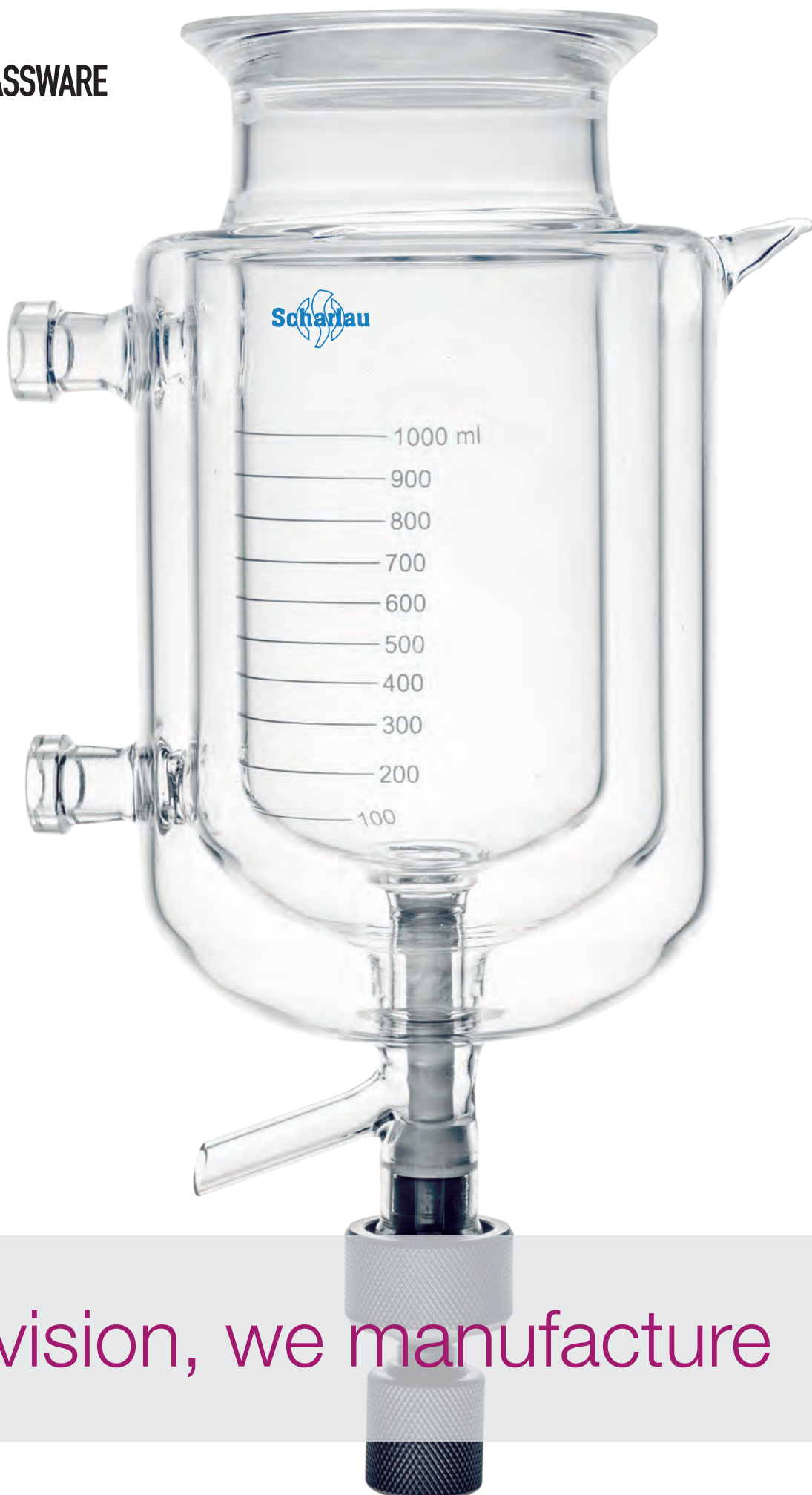

You envision, we manufacture

Custom-made glassware

In over 30 years we have accumulated a vast library of over 1000 different pieces of special glassware made to order. Let us know your special request and we shall quote you our best offer. In addition, we offer also other services, such as amber painting, plastic coating or production of complete glass-reaction configurations.

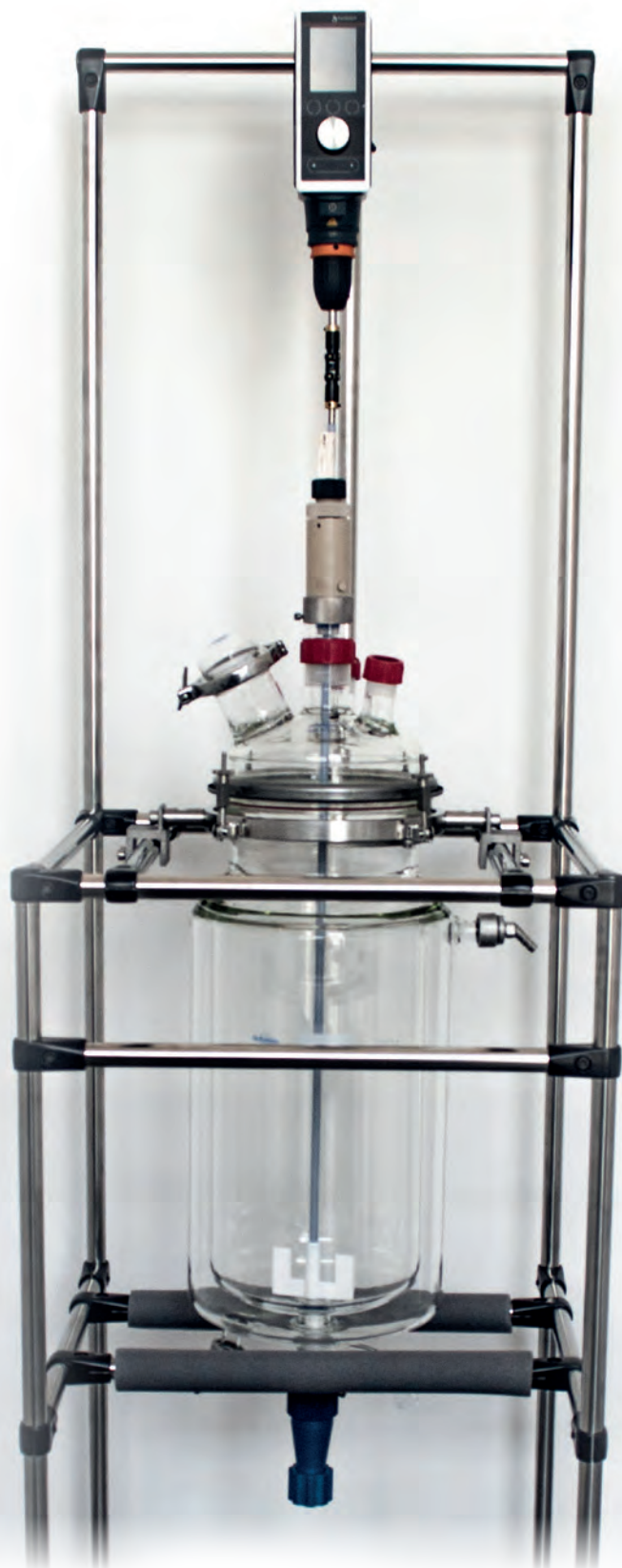

SCHARLAU GLASSWARE

OUR PACKAGING

Our packaging

Thinking about the best way to deliver our glassware, we have developed new packaging, in order to prevent breakages during transport. Our box for molded glass products contains ten separated spaces for safe delivery. Similarly, volumetric glassware is packed into a box of 2 and this box can be combined into the next bigger unit of 4 boxes for safer delivery.



Safe handling of glassware

- With volumetric glassware, we have to ensure reproducibility. This is why perfect wetting has to be achieved in order not to distort the meniscus and to wear protective clothing such as cut resistant gloves, eye protection, aprons and lab coats when manipulating and working with laboratory glassware.
- Do not use chipped or broken glassware as you may cut yourself. Such glassware also breaks more easily.
- Use safety shields, nets or coatings to prevent broken glass from hitting you.
- Check all glassware for damage as even small cracks, chips or scratches affect glassware strength.
- Never heat damaged glassware as resistance to heat is equally compromised.
- Use wire gauze when heating with an open flame or use only up to a medium heat when using a hot plate.
- Heat up and cool down glassware as slowly as possible, even when using Borosilicate glass, which has a very low coefficient of expansion. Maximum working temperature for Borosilicate glass is 500°C, however special precautions must already be taken for working temperatures above 150°C.
- Do not heat extra thick glassware. This glassware is ideal for working under vacuum when higher mechanical strength is required, but this glass is less heat resistant.
- Do not subject ordinary, thin walled, laboratory glassware to pressure or vacuum.
- Lift glassware by the body and not by the more fragile rims or side arms.
- When heating glass bottles, loosen the caps.
- Be careful when sliding tubing over sidearms. Always use protective gloves.
- Never pipette by mouth. You may get intoxicated, burn your mouth or cut your lip.
- Do not use excessive force and wear protective gloves when trying to free stuck jointed glassware. Use only gentle tapping or rocking of the two sides of the joints. The use of threaded safety joints prevents joints from sticking.
- Do not leave pipettes or glass-rods sticking out of beakers, bottles or flasks.
- Do not heat glassware to over 420°C. This will cause stresses in the glassware that will eventually cause it to break.



CLEANING OF GLASSWARE

Cleaning of glassware

General

The cleaning procedure for glassware depends on the type of material in it.

Borosilicate glass has excellent resistance to most acids except hydrofluoric acid. Strong alkaline solutions will also attack the glass, which is why detergents should be diluted up to no more than 2% strength. Avoid exposure to detergents for long periods and prevent the same from drying on the glass.

- Glassware should be cleaned as soon as possible to prevent residues from hardening.
- Ideally, give glassware a rinse or soak with organic solvent to remove grease and then another thorough rinse with water.
- Cleaning can be done in a glass washing machine or manually.

Washing machine

Choose from the wide variety of detergent formulations offered by laboratory specialists for washing machines, depending on the residues you need to eliminate. These formulations are optimised for typical laboratory residues. Check that the support racks and pins are well coated with a nonabrasive material to prevent the glass from being scratched or broken by a hard surface.

Manual wash

Use only soft sponges or other soft clothes or plastic core brushes with non-abrasive bristles.

Choose from the wide variety of detergent formulations offered by laboratory specialists for manual washing, depending on the residues you need to eliminate. These formulations are optimised for typical laboratory residues.

Specialised cleaning methods

1. Permanganate stains. Use a mixture of equal volume 3% sulphuric acid and 3% hydrogen peroxide.

2. Iron stains. Use a solution containing equal parts of hydrochloric acid and water.

3. Bacteriological material. Glassware should be soaked in a disinfectant solution or steam autoclaved. After that, clean with a detergent.

Special precautions during the cleaning process:

- Do not use any abrasive sponges as used in kitchens for cleaning pots.
- Avoid any detergents or cleaning solutions that contain abrasive particles.
- Remove any hard objects like metal spatulas, stirring rods or brushes immediately. They can break the glass or scratch it.
- Strong alkaline domestic or industrial detergents will dissolve the glass and eventually cause breakage.
- Remove any kind of metal jewellery as well as rings with gems if you plan to put your hand inside glassware.

CARE AND HANDLING OF GLASSWARE

Ground-glass joints and glass stopcocks

If ground-glass joints are not lubricated, they may “freeze”. Ground joints must be carefully cleaned before lubrication to avoid any particles from scratching the surface and causing leakage.

Apiezon, silicone-based, and fluoroether-based greases can be used depending on the purpose:

- Apiezon or similar hydrocarbon-based greases are cheap and suitable for high vacuum applications. As they dissolve well in organic solvents, the advantage is that the glass can be cleaned well with hexanes or pentane. The disadvantage, however, is that this lubricant may easily contaminate reaction mixtures.
- Silicone-based greases are relatively inert, but contamination of reaction mixtures cannot be excluded completely. Soaking in a base bath is the best method to remove this lubricant as it is resistant to organic solvents.
- Fluoroether-based greases are the most inert of all and resistant to solvents, acids, bases, and oxidisers. The drawback is that they are quite expensive and not easily removed by cleaning.

Proper lubricating of ground-joints is done by applying grease only on the upper part of the inner joint. The joint is properly lubricated if it appears clear and without striations.

In order to lubricate stopcocks, spread two circular bands of grease around the plug of the stopcock. After having inserted the plug into the barrel and twisting several times, the assembly should be completely transparent. Avoid plugging the bore by using too much grease.

Stopcocks with PTFE Plugs (Polytetrafluoroethylene)

PTFE offers a number of advantages over glassware in the sense that it is very tough, heat resistant and durable. PTFE plugs do not “freeze” and hence do not require any lubricant that may cause contamination.

PTFE properties

Properties	Advantages
Extreme chemical resistance	Withstands corrosive environments Does not contaminate
Insoluble	No contamination in ultra-pure or corrosive applications
High thermal stability	Working temperatures from -200 to +300°C Does not melt to a liquid phase - an in-built safety feature
Exceptional electrical properties	Extremely high electrical resistance Low dielectric constant and dielectric loss factor
Does not support tracking Lowest coefficient of friction of all solids Other materials exhibit little or no adhesion to PTFE Good flexural properties	Exceptional anti-adhesion properties
Outstanding resistance to fatigue No embrittlement in liquid helium	

Here are some tips to obtain maximum performance:

- Before you start using a new plug, disassemble it, rinse the plug and barrel with acetone and then dry everything.
- The PTFE washer should always be placed adjacent to the end of the glass barrel to ensure minimal friction. After tightening the plug, it should turn only slightly harder than a lubricated glass plug. Solid particles can easily score the plug around the bore and the plug may leak.
- Do not use stopcocks with PTFE plugs on a vessel used for long-term storage of liquids known to attack glass. The surface of the barrel may become roughened and leakage may occur.



NOTE: Young stopcocks for high vacuum available on request.

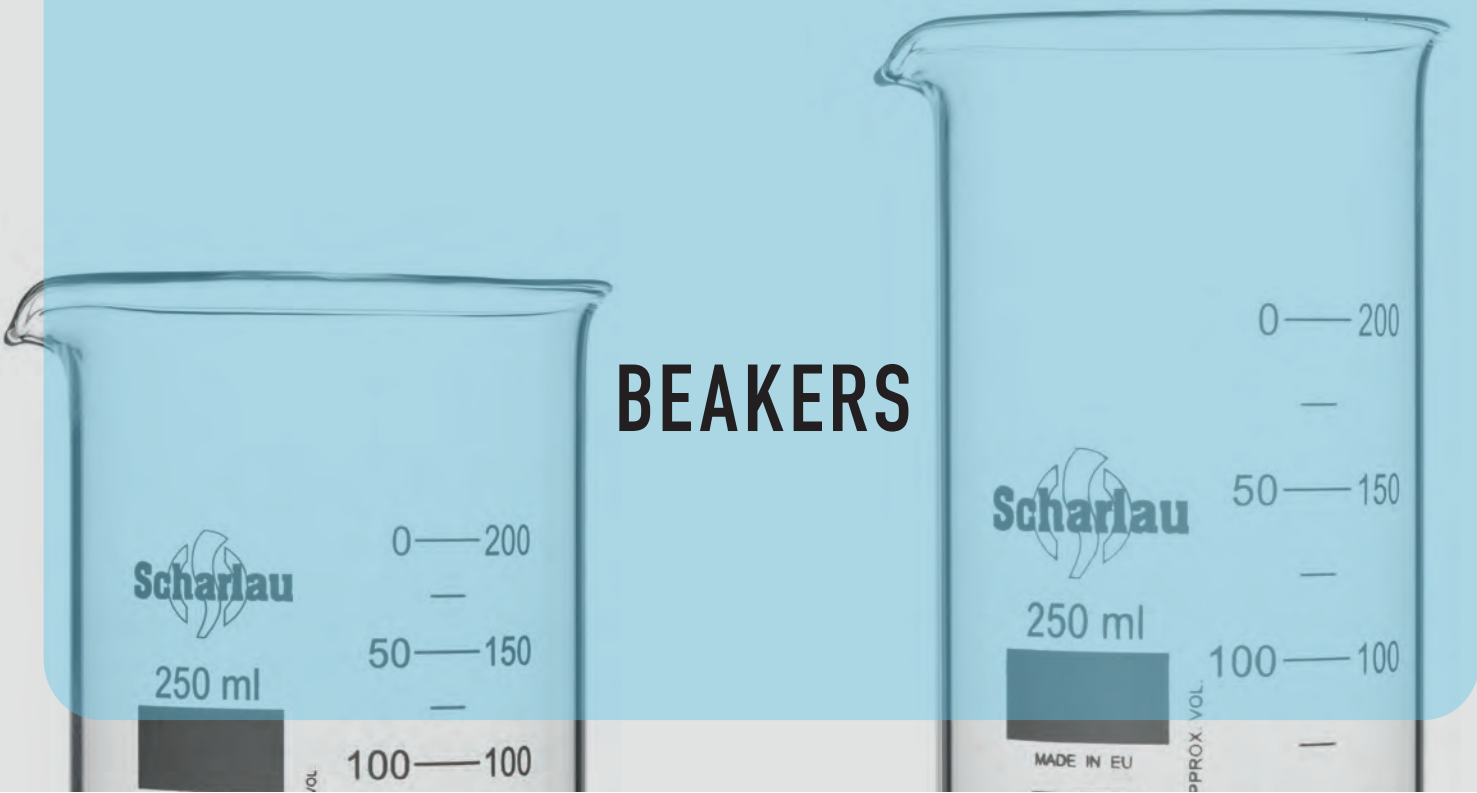

BEAKERS

BEAKERS

BEAKERS, LOW FORM, GRADUATED, BOROSILICATE GLASS DIN 12331



CAP. (ml)	Ø (mm)	HEIGHT (mm)	RETRACE CODE	DOUBLE GRADUATED SCALE	PACK (U.)	ART. NO.
25	34	50	No	No	10	1033550103
50	42	60	Yes	Yes	10	1033550104
100	50	70	Yes	Yes	10	1033510105
150	60	80	No	No	10	1033510106
250	70	95	Yes	Yes	10	1033510108
400	80	110	No	No	10	1033510110
600	90	125	Yes	Yes	10	1033510112
800	100	135	No	No	10	1033510113
1000	105	145	Yes	Yes	10	1033510114
2000	130	185	Yes	Yes	4	1033510115

BEAKERS, TALL FORM, GRADUATED, BOROSILICATE GLASS DIN 12331



CAP. (ml)	Ø (mm)	HEIGHT (mm)	RETRACE CODE	DOUBLE GRADUATED SCALE	PACK (U.)	ART. NO.
25	28	60	No	No	10	1033550203
50	38	70	Yes	Yes	10	1033550204
100	48	80	Yes	Yes	10	1033510205
150	54	95	Yes	Yes	10	1033510206
250	60	120	Yes	Yes	10	1033510208
400	70	130	Yes	Yes	10	1033510210
600	80	150	No	No	10	1033510212
800	90	175	No	No	10	1033510213
1000	95	180	Yes	Yes	10	1033510214
2000	120	240	No	No	4	1033510215

CONDENSERS

CONDENSERS

ALLIHN CONDENSER

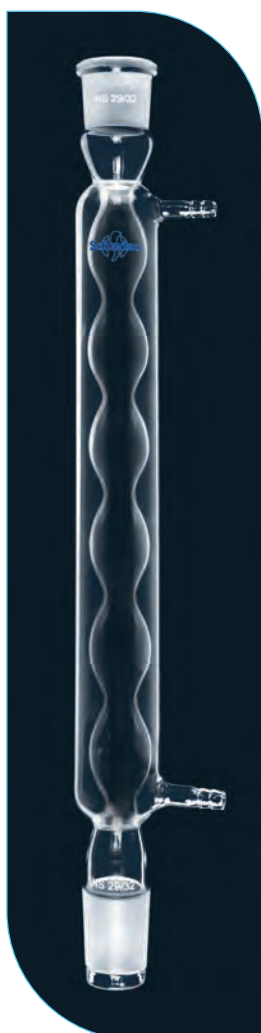

GROUND JOINTS	EFFECTIVE LENGTH (mm)	PACK (U.)	ART. NO.
C/S-14/23	200	1	073-000446
C/S-29/32	200	1	073-000447
C/S-29/32	300	1	073-000449
C/S-29/32	500	1	073-000451

AIR CONDENSER, CONE

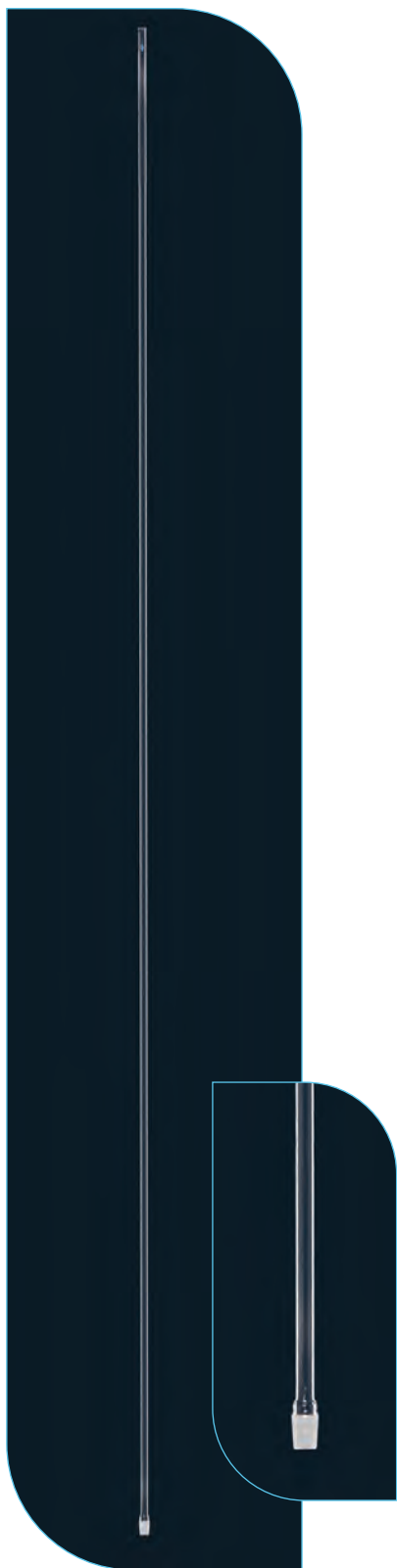

GROUND JOINTS	EFFECTIVE LENGTH (mm)	PACK (U.)	ART. NO.
C-14/23	500	1	073-000410
C-29/32	500	1	073-000416
C-14/23	1000	1	073-000411
C-29/32	1000	1	073-000412

DIMROTH JACKETED CONDENSER

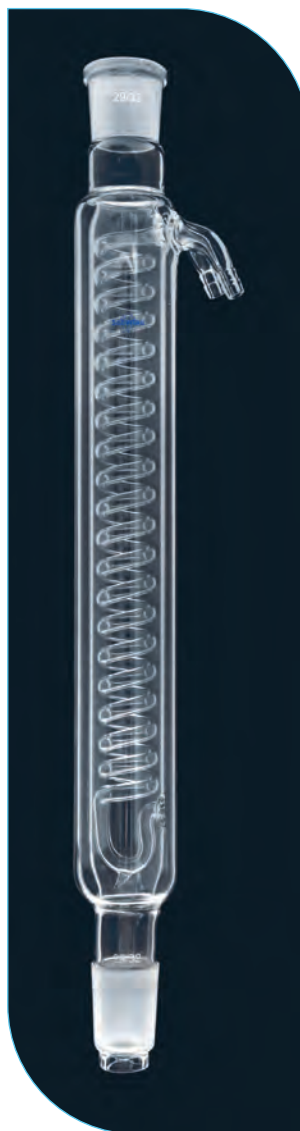

GROUND JOINTS	EFFECTIVE LENGTH (mm)	PACK (U.)	ART. NO.
C/S-29/32	300	1	073-000481
C/S-29/32	400	1	073-400481

DIMROTH CONDENSERS WITH GROUND JOINTS



GROUND JOINTS	EFFECTIVE LENGTH (mm)	PACK (U.)	ART. NO.
C/S-14/23	110	1	073QS03287
C/S-14/23	150	1	073-000473
C/S-14/23	200	1	073-000474
C/S-29/32	200	1	073-000475
C/S-29/32	250	1	073-000476
C/S-29/32	300	1	073-000477
C/S-29/32	400	1	073-0162/4

LIEBIG WEST CONDENSERS WITH GROUND JOINTS



GROUND JOINTS	EFFECTIVE LENGTH (mm)	PACK (U.)	ART. NO.
C/S-14/23	120	1	073-000425
C/S-14/23	200	1	073-000426
C/S-14/23	250	1	073-000427
C/S-14/23	300	1	073-000428
C/S-29/32	250	1	073-000429
C/S-29/32	300	1	073-000430
C/S-29/32	400	1	073-000431
C/S-29/32	500	1	073-000432
C/S-29/32	600	1	073-000433

FILTRATION

FILTRATION: FILTRATION SYSTEMS

FILTRATION ASSEMBLY FOR 47 mm MEMBRANES



DESCRIPTION	PACK (U.)	ART. NO.
Complete	1	073-001119
47 mm filter support	1	073-001120
Support funnel 300 ml	1	073-001121
Metal clip	1	073-Q279-5
1000 ml filtering flask	1	0033768104
Neoprene plug number 8	1	073-426151

See **filtration membranes** in **CONSUMABLES**.

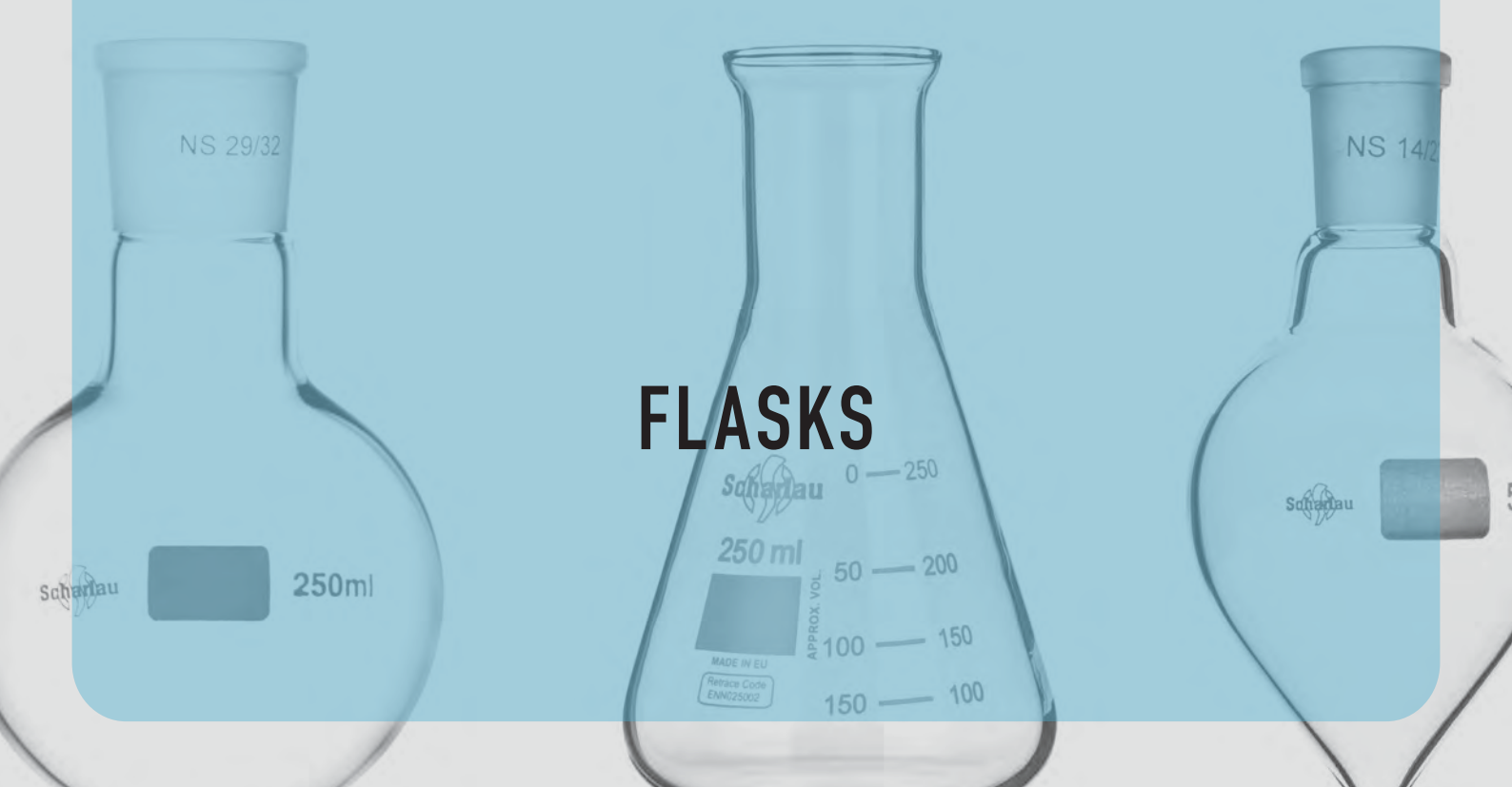

FLASKS

FLASKS: ERLENMEYER FLASKS

ERLENMEYER FLASKS NARROW NECK DIN 1773



ERLENMEYER FLASKS WIDE NECK DIN 1773



CAP. (ml)	Ø NECK (mm)	HEIGHT (mm)	DOUBLE SCALE GRADUATED	RETRACE CODE	PACK (U.)	ART. NO.
25	22	75	No	No	10	1033567303
50	22	90	No	No	10	1033567304
100	22	105	No	No	10	1033527305
200	34	135	No	No	10	1033527307
250	34	145	Yes	Yes	10	1033527308
300	34	160	No	No	10	1033527309
500	34	180	Yes	Yes	10	1033527311
1000	42	220	Yes	Yes	10	1033527314
2000	50	280	No	No	10	1033567315

CAP. (ml)	Ø NECK (mm)	HEIGHT (mm)	DOUBLE SCALE GRADUATED	RETRACE CODE	PACK (U.)	ART. NO.
25	31	70	No	No	10	1033567503
50	34	85	No	No	10	1033567504
100	34	105	Yes	Yes	10	1033527505
200	50	131	No	No	10	1033527507
250	50	140	Yes	Yes	10	1033527508
300	50	156	No	No	10	1033527509
500	50	175	Yes	Yes	10	1033527511
1000	50	220	No	No	10	1033527514

ERLENMEYER FLASKS WITH GROUND SOCKET



CAP. (ml)	SOCKET	PACK (U.)	ART. NO.
25	14/23	10	073-100134
50	14/23	10	073-100135
50	29/32	10	073-113529
100	14/23	10	073-100136
100	19/26	10	073-100137
100	29/32	10	073-100138
250	14/23	10	073-100139
250	24/29	10	0731024140
250	29/32	10	073-100140
500	29/32	10	073-100142
1000	24/29	10	0731024144
1000	29/32	10	073-100144

FLASKS: SPHERICAL FLASKS

FLASKS, GROUND SOCKET, ROUND BOTTOM, SHORT NECK, CLEAR GLASS



CAP. (ml)	SOCKET	PACK (U.)	ART. NO.
10	14/23	10	073-100002
25	14/23	10	073-100003
50	14/23	10	073-100004
50	19/26	10	073-101904
100	14/23	10	073-100005
100	19/26	10	073-101905
100	24/29	10	073-102405
100	29/32	10	073-100006
250	14/23	10	073-100007
250	19/26	10	073-101907
250	24/29	10	073-102407
250	29/32	10	073-100008
500	19/26	10	073-101909
500	24/29	10	073-102409
500	29/32	10	073-100009
1000	24/29	10	073-102410
1000	29/32	10	073-100010
2000	29/32	10	073-100012

FLASKS, GROUND SOCKET, ROUND BOTTOM, SHORT NECK, AMBER GLASS



CAP. (ml)	SOCKET	PACK (U.)	ART. NO.
50	14/23	10	073A100004
100	14/23	10	073A100005
100	29/32	10	073A100006
250	14/23	10	073A100007
250	29/32	10	073A100008
500	29/32	10	073A100009
1000	29/32	10	073A100010

SCHARLAU HEATING BLOCKS

Made of anodised aluminium alloy, our range of heating blocks are able to heat round bottom flasks from 10 ml to 1 l on a stirring hotplate. The blocks are compatible with any stirring hotplate and can be placed anywhere on top of it.

The lateral hole allows block temperature measurement using a PT100 probe and the block bottom holes permit the release of fumes in case liquid should accidentally leak from the flask.

Save energy and money using our heating blocks. Oil should be replaced in order to maintain safe working conditions, which has an additional cost. On the other hand, the oil degrades over time and can produce toxic fumes. Replace oil baths and heating mantles increasing speed, clean-liness and safety.

ALUMINIUM BLOCKS FOR USE ON TOP OF HOTPLATE



Made of an anodised aluminium alloy. Suitable for heating round bottom flasks from 10 ml to 1 l on a hotplate stirrer. Compatible with any hotplate stirrer and can be placed anywhere on top of it. The lateral hole allows block temperature measurement using a PT100 probe. Block bottom holes allow the release of fumes in case liquid should accidentally leak from the flask. Replace oil baths and heating mantles increasing speed, cleanliness and safety.

DESCRIPTION	PACK (U.)	ART. NO.
Aluminium heating block for 10 ml flask	1	CAL-000010
Aluminium heating block for 25 ml flask	1	CAL-000025
Aluminium heating block for 50 ml flask	1	CAL-000050
Aluminium heating block for 100 ml flask	1	CAL-000100
Aluminium heating block for 250 ml flask	1	CAL-000250
Aluminium heating block for 500 ml flask	1	CAL-000500
Aluminium heating block for 1000 ml flask	1	CAL-001000

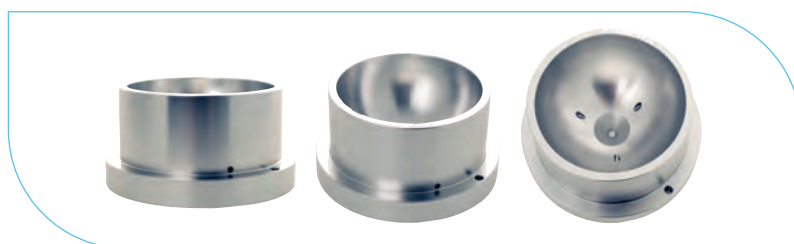

FLASKS: HEART-SHAPED FLASKS

HEART-SHAPED FLASKS, SINGLE NECK



CAPACITY (ml)	SOCKET	PACK (U.)	ART. NO.
5	14/23	1	073-125005
10	14/23	1	073-125010
25	14/23	1	073-000125
50	14/23	1	073-000126
100	14/23	1	073-000127
250	14/23	1	073-000128
250	29/32	1	073-000129

FLASKS: EVAPORATING FLASKS

PEAR-SHAPED EVAPORATING FLASKS



CAP. (ml)	SOCKET	EQUIV. BÜCHI	EQUIV. HEIDOLPH	PACK (U.)	ART. NO.
50	NS 29/32	000431	-	1	073-000053
100	NS 29/32	000432	514-71000-00	1	073-000054
250	NS 29/32	000433	514-72000-00	1	073-000055
500	NS 29/32	000434	514-73000-00	1	073-000056
1000	NS 29/32	000435	514-74000-00	1	073-000057
2000	NS 29/32	000436	514-75000-00	1	073-572000

RECEIVING FLASKS, ROUND BOTTOM, SPHERICAL JOINT



CAP. (ml)	SOCKET	EQUIV. BÜCHI	EQUIV. HEIDOLPH	PACK (U.)	ART. NO.
500	S 35/20	000424	514-83000-00	1	073-000025
1000	S 35/20	000425	514-84000-00	1	073-000027
2000	S 35/20	000426	514-85000-00	1	073-102000
3000	S 35/20	000427	514-86000-00	1	073-103000

FUNNELS

FUNNELS

FUNNELS SHORT STEM, BOROSILICATE GLASS



FUNNELS FOR POWDERED PRODUCTS



Ø OUTER (mm)	Ø STEM (mm)	STEM LENGTH (mm)	PACK (U.)	ART. NO.
60	25	14	10	1033793307
70	30	16	10	1033793308
80	30	17	10	1033793309
100	35	22	10	1033793310

Borosilicate 3.3 glass. Opening angle 60°, fused edge. Flat inner surface.

Ø OUTER (mm)	Ø STEM (mm)	STEM LENGTH (mm)	PACK (U.)	ART. NO.
30	6	30	10	1033793101
35	6	35	10	1033793102
45	6	45	10	1033793104
50	8	50	10	1033793105
55	8	55	10	1033793106
60	8	60	10	1033793107
75	8	70	10	1033793108
80	8	80	10	1033793109
100	12	100	10	1033793110

SEPARATING FUNNEL, CONICAL PTFE STOPCOCK, WITH STOPPER



CAP. (ml)	SOCKET	PACK (U.)	ART. NO.
50	19/26	1	073-000313
100	19/26	1	073-000314
250	29/32	1	073-000315
500	29/32	1	073-000316
1000	29/32	1	073-000317

GLASSWARE FOR INERT ATMOSPHERE

GLASSWARE FOR INERT ATMOSPHERE: SCHLENK FLASKS, TUBES AND FILTERS

SCHLENK NITROGEN TUBES, GROUND SOCKET AND GLASS STOPCOCK



CAPACITY (ml)	SOCKET	PACK (U.)	ART. NO.
10	14/23	1	073-370113
25	14/23	1	073-370122
50	14/23	1	073-370128
100	14/23	1	073-370137
250	14/23	1	073-370149

SCHLENK NITROGEN TUBES, GROUND CONE AND GLASS STOPCOCK



CAPACITY (ml)	CONE	PACK (U.)	ART. NO.
10	14/23	1	073-370213
25	14/23	1	073-370222
50	14/23	1	073-370228
100	14/23	1	073-370237
250	14/23	1	073-370249

LABORATORY BOTTLES

LABORATORY BOTTLES

REAGENT BOTTLE, WITH BLUE SCREW CAP



Clear borosilicate glass bottle, with GL45 thread, graduated, blue cap and pouring ring, ISO 4796. Made of borosilicate glass 3.3. The bottle, pouring ring and screw cap can be sterilised. *It includes retrace code and double graduated scale.

CAP. (ml)	THREAD ISO	DOUBLE GRADUATED SCALE	RETRACE CODE	PACK (U.)	ART. NO.
100	GL45	Yes	Yes	10	2733799005
250	GL45	Yes	Yes	10	2733799006
500	GL45	Yes	Yes	10	2733799007
1000	GL45	Yes	Yes	10	2733799008

OTHER PRODUCTS

OTHER PRODUCTS

GLASS PASTEUR PIPETTES



LENGTH (mm)	PACK (U.)	ART. NO.
160	250	073-001734
220	250	073-001735

SODA GLASS PETRI DISHES



Ø (mm)	HEIGHT (mm)	PACK (U.)	ART. NO.
60	15	1	359-796001
80	15	1	359-796003
100	20	1	359-796006
150	25	1	359-796008
180	30	1	359-796009
200	30	1	359-796010

HEXAGONAL GLASS STOPPERS



CONE	PACK (U.)	ART. NO.
7/16	10	073-10716
10/19	10	073-101043
12/21	10	073-101044
14/23	10	073-101045
19/26	10	073-101046
24/29	10	073-101047
29/32	10	073-101048
34/35	10	073-101049
45/40	10	073-101050

HEXAGONAL POLYETHYLENE STOPPERS



CONE	PACK (U.)	ART. NO.
7/16	10	073-10716P
10/19	10	073-101064
12/21	10	073-101065
14/23	10	073-101066
19/26	10	073-101067
24/29	10	073-101068
29/32	10	073-101069
45/40	10	073-101075

PYCNOMETERS

PYCNOMETERS

GAY-LUSSAC GLASS PYCNOMETERS



According to ISO 3507. Capacity adjustment recorded in the pycnometer. Conformity certified. Frosted plug 10/19 with capillary. 3.3 borosilicate glass material.

CAP. (ml)	PACK (U.)	ART. NO.
10	1	073-000986
25	1	073-000987
50	1	073-000988
100	1	073-000989

RENAULT GLASS PYCNOMETERS FOR SOLIDS



Capacity adjustment recorded in the pycnometer. Conformity certified. Borosilicate glass 3.3.

CAP. (ml)	GROUND JOINTS	PACK (U.)	ART. NO.
10	12/21	1	073-000990
25	14/23	1	073-000991
50	14/15	1	073-000992
100	19/15	1	073-000993

SOXHLET EXTRACTORS

SOXHLET EXTRACTORS

COMPLETE SOXHLET EXTRACTOR OF 125 ml



DESCRIPTION	CONE	SOCKET	PACK (U.)	ART. NO.
Complete	-	-	1	073-000729
Extractor piece 125 ml	29/32	45/40	1	073-000730
Dimroth condenser 200 mm useable height	45/40	-	1	073-000479
Flat bottom flask 250 ml	-	29/32	1	073-000042

See **cellulose extraction thimbles** in **CONSUMABLES**.

COMPLETE SOXHLET EXTRACTOR OF 250 ml



DESCRIPTION	CONE	SOCKET	PACK (U.)	ART. NO.
Complete	-	-	1	073-000731
Extractor piece 250 ml	29/32	55/44	1	073-000732
Dimroth condenser 200 mm useable height	55/44	-	1	073-000480
Flat bottom flask 500 ml	-	29/32	1	073-000043

FILTER CRUCIBLES WITH SINTERED DISK POROSITY 2



DESCRIPTION	Ø EXT.XH (mm)	CAP. (ml)	PACK (U.)	ART. NO.
Filter crucibles 50 ml	24x70	20	1	073-000733
Filter crucibles 125 ml	40x90	75	1	073-000734
Filter crucibles 250 ml	44x130	170	1	073-000735

TUBES

GLASS SODA TEST TUBE RIMLESS AND ROUND BOTTOM



Round bottom glass tubes. Made of soda glass. The high quality of those tubes is reflected in the uniformity of their wall thickness and of their diameter and height dimensions. Supplied in small quantities per case for a more convenient use in laboratory.

CAP. (ml)	DIM. ØxLENGTH (mm)	THICKNESS (mm)	PACK (U.)	ART. NO.
4	9,75x75	0,6	4x250	027-801075
6	11,6x75	0,6	4x250	027-801275
10	12,7x100	0,6	4x250	027-813100
15	15,75x100	0,6	4x250	027-816100
22	16x150	0,7	4x250	027-816150
27	16x160	0,55	500	027-816160
28	18x150	0,85	2x250	027-818150
34	20x150	0,85	100	027-820150
47	19,25x200	0,85	250	027-820200

BOROSILICATE GLASS TEST TUBE RIMLESS AND ROUND BOTTOM



Round bottom glass tubes. Made of borosilicate glass 3.3. The high quality of those tubes is reflected in the uniformity of their wall thickness and of their diameter and height dimensions.

CAP. (ml)	DIM. ØxLENGTH (mm)	THICKNESS (mm)	TUBES/BOX	PACK (U.)	ART. NO.
3	10x75	0,6	100	1	124-01075P
4	10x100	0,6	100	1	124-10100P
5	12x75	0,8	250	1	124-01275P
6	12x100	0,8	100	1	124-12100P
8	12x120	0,8	250	1	124-12120P
15	15x150	1	250	1	124-15150P
15	16x100	1	250	1	124-16100B
20	16x160	1	250	1	124-16160B
30	18x180	1	100	1	124-18180P
40	20x200	1	100	1	124-20200P

DURHAM (BELL) TUBE



Durham bell to determine the gas production of microorganisms. Without bevel edge. Made of soda glass.

BOTTOM	CAP. (ml)	ØxLENGTH (mm)	MATERIAL	TUBES/BOX	PACK (U.)	ART. NO.
Round	0,6	6x20	Soda	100	1	124-00620C
Round	0,9	6x30	Soda	100	1	124-00630C
Round	1,1	6x40	Soda	100	1	124-00640C
Round	1,1	7x30	Soda	100	1	124-00730C
Round	1,4	7x40	Soda	100	1	124-00740C
Round	1,5	8x30	Soda	100	1	124-00830C

VOLUMETRIC MATERIAL

VOLUMETRIC MATERIAL: BURETTES

GLASS BURETTES

Scharlau burettes are all class AS and each one is provided with a calibration certificate and serial number. Its marking is indelible and all variants exist also in amber glass. With Schellbach stripe for readability. They conform with ISO 385.

STRAIGHT BURETTES, CONICAL PTFE STOPCOCK

CAP. (ml)	GRADUATION (ml)	PACK (U.)	ART. NO.
10	1/20	4	273-001520
25	1/10	4	273-001521
50	1/10	4	273-001522

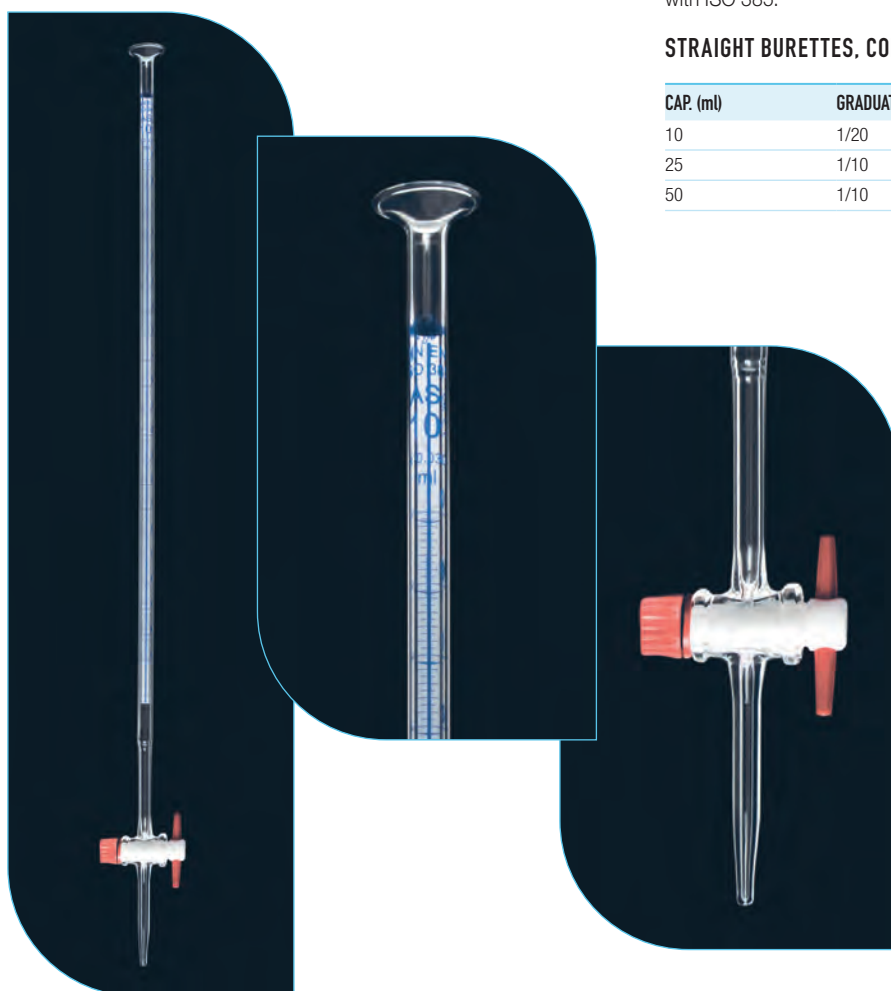

VOLUMETRIC MATERIAL: FLASKS

VOLUMETRIC FLASKS, BOROSILICATE GLASS, CLASS A, PE STOPPER, SERIAL NUMBER AND CONFORMITY CERTIFIED



Borosilicate glass 3.3. Blue tinted. Lot number. Complies with norm ISO 1042.

CAP. (ml)	SOCKET	TOL. ± (ml)	PACK (U.)	ART. NO.
5	10/19	0,025	8	273-001629
10	10/19	0,025	8	273-001630
20	10/19	0,04	8	2732163120
25	12/21	0,04	8	273-201631
50	12/21	0,06	8	273-201632
100	14/23	0,10	8	273-201633
200	14/23	0,15	8	273-201634
250	14/23	0,15	8	273-201635
500	19/26	0,25	8	273-201636
1000	24/29	0,40	8	273-201637
2000	29/32	0,60	8	273-001638

VOLUMETRIC FLASKS, AMBER GLASS, CLASS A, PE STOPPER, SERIAL NUMBER AND CONFORMITY CERTIFIED



Borosilicate glass 3.3. White coated. Lot number. Complies with norm ISO 1042. Amber glass.

CAPACITY (ml)	SOCKET	TOL. ± (ml)	PACK (U.)	ART. NO.
5	10/19	0,025	8	273A001629
10	10/19	0,025	8	273A001630
20	10/19	0,04	8	273A163120
25	12/21	0,04	8	273A201631
50	12/21	0,06	8	273A201632
100	14/23	0,10	8	273A201633
200	14/23	0,15	8	273A201634
250	14/23	0,15	8	273A201635
500	19/26	0,25	8	273A201636
1000	24/29	0,40	8	273A201637
2000	29/32	0,60	8	273A001638

VOLUMETRIC FLASKS WITH COLOURED NECK, CLASS A, WITH PE STOPPER, LOT NUMBER AND CONFORMITY CERTIFICATE

Prevent laboratory mistakes and the contamination of mixed samples. Easy identification samples or flasks in shared laboratories. Available in 4 colours: red, green, blue and yellow. Resistant to usual laboratory cleaning.



VOLUMETRIC FLASKS RED COLOUR ■

CAPACITY (ml)	SOCKET	COLOUR	TOL. ± (ml)	PACK (U.)	ART. NO.
10	10/19	Red	0,025	8	273D001630
20	10/19	Red	0,04	8	273D263120
25	12/21	Red	0,04	8	273D201631
50	12/21	Red	0,06	8	273D201632
100	14/23	Red	0,10	8	273D201633
200	14/23	Red	0,15	8	273D201634
250	14/23	Red	0,15	8	273D201635
500	19/26	Red	0,25	8	273D201636
1000	24/29	Red	0,40	8	273D201637

VOLUMETRIC FLASKS GREEN COLOUR ■

CAPACITY (ml)	SOCKET	COLOUR	TOL ± (ml)	PACK (U.)	ART. NO.
10	10/19	Green	0,025	8	273N001630
20	10/19	Green	0,04	8	273N263120
25	12/21	Green	0,04	8	273N201631
50	12/21	Green	0,06	8	273N201632
100	14/23	Green	0,10	8	273N201633
200	14/23	Green	0,15	8	273N201634
250	14/23	Green	0,15	8	273N201635
500	19/26	Green	0,25	8	273N201636
1000	24/29	Green	0,40	8	273N201637

VOLUMETRIC FLASKS BLUE COLOUR ■

CAPACITY (ml)	SOCKET	COLOUR	TOL. ± (ml)	PACK (U.)	ART. NO.
10	10/19	Blue	0,025	8	273E001630
20	10/19	Blue	0,04	8	273E263120
25	12/21	Blue	0,04	8	273E201631
50	12/21	Blue	0,06	8	273E201632
100	14/23	Blue	0,10	8	273E201633
200	14/23	Blue	0,15	8	273E201634
250	14/23	Blue	0,15	8	273E201635
500	19/26	Blue	0,25	8	273E201636
1000	24/29	Blue	0,40	8	273E201637

VOLUMETRIC FLASKS YELLOW COLOUR ■

CAPACITY (ml)	SOCKET	COLOUR	TOL. ± (ml)	PACK (U.)	ART. NO.
10	10/19	Yellow	0,025	8	273W001630
20	10/19	Yellow	0,04	8	273W263120
25	12/21	Yellow	0,04	8	273W201631
50	12/21	Yellow	0,06	8	273W201632
100	14/23	Yellow	0,10	8	273W201633
200	14/23	Yellow	0,15	8	273W201634
250	14/23	Yellow	0,15	8	273W201635
500	19/26	Yellow	0,25	8	273W201636
1000	24/29	Yellow	0,40	8	273W201637



VOLUMETRIC MATERIAL: PIPETTES

**VOLUMETRIC PIPETTES,
ONE MARK, CLASS AS,
SERIALIZED AND CERTIFIED,
SODA-LIME GLASS**



**VOLUMETRIC PIPETTES,
TWO MARKS, CLASS AS,
SERIALIZED AND CERTIFIED,
SODA-LIME GLASS**



**GRADUATED PIPETTES,
CLASS AS, TYPE 3,
TOTAL DELIVERY, SERIALIZED
AND CERTIFIED ISO 835**

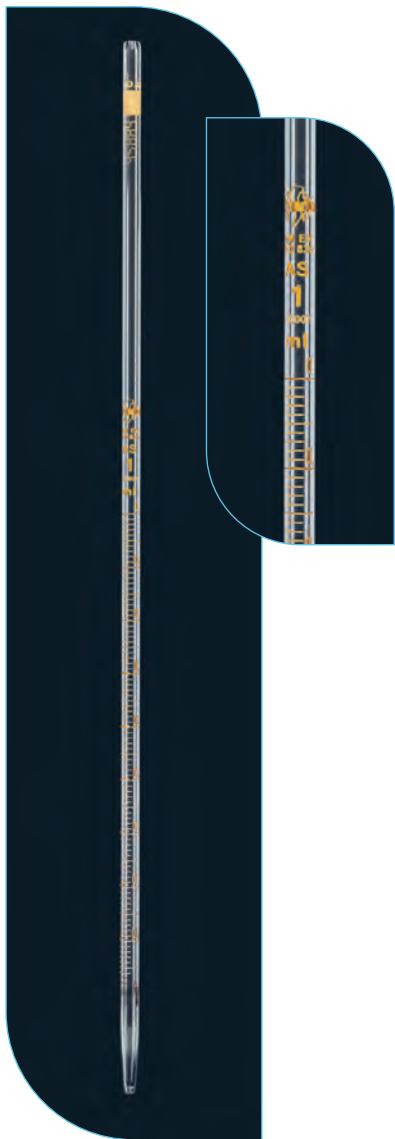

CAP. (ml)	TOL ± (ml)	PACK (U.)	ART. NO.
1	0,008	10	273-991676
2	0,01	10	273-991677
5	0,015	10	273-991678
10	0,02	10	273-991679
20	0,03	10	273-991681
25	0,03	10	273-991682
50	0,05	10	273-991683

CAP. (ml)	TOL ± (ml)	PACK (U.)	ART. NO.
1	0,008	10	273-991696
2	0,01	10	273-991697
5	0,015	10	273-991698
10	0,02	10	273-991699
20	0,03	10	273-991701
25	0,03	10	273-991702
50	0,05	10	273-991703

CAP. (ml)	DIVISION (ml)	TOL ± (ml)	PACK (U.)	ART. NO.
0,5	0,01	0,006	10	273-991305
1	0,01	0,007	10	273-991715
2	0,02	0,01	10	273-991717
5	0,05	0,03	10	273-991719
10	0,1	0,05	10	273-991720
25	0,1	0,1	10	273-991721

VOLUMETRIC MATERIAL: GRADUATED CYLINDERS

BOROSILICATE GLASS GRADUATED CYLINDERS, CLASS A, HEXAGONAL BASE, WITH POUR SPOUT, SERIALIZED AND CERTIFIED ISO 4788

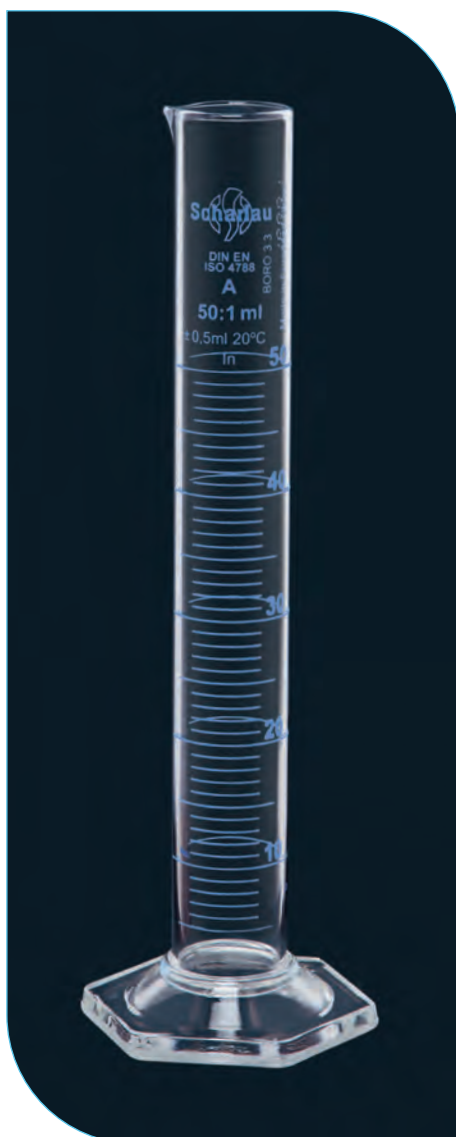

BOROSILICATE GLASS GRADUATED CYLINDERS, AMBER PRINTED. CLASS A, HEXAGONAL BASE, WITH POUR SPOUT, SERIALIZED AND CERTIFIED ISO 4788

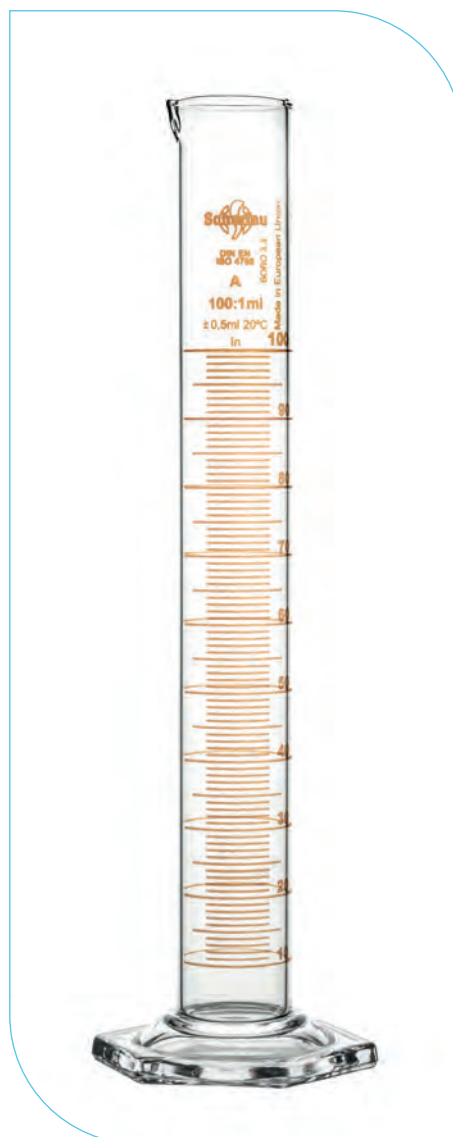

CAP. (ml)	DIVISION (ml)	TOLERANCE ± (ml)	COLOUR GRAD.	PACK (U.)	ART. NO.
10	1/5	0,10	Blue	8	273-201750
25	1/2	0,25	Blue	8	273-201751
50	1/1	0,5	Blue	8	273-201752
100	1/1	0,5	Blue	8	273-201753
250	2/1	1	Blue	8	273-201754
500	5/1	2,5	Blue	8	273-001755
1000	10/1	5	Blue	8	273-001756
2000	20/1	10	Blue	8	273-001757

CAP. (ml)	DIVISION (ml)	TOLERANCE ± (ml)	COLOUR GRAD.	PACK (U.)	ART. NO.
10	1/5	0,10	Amber	8	273-201743
25	1/2	0,25	Amber	8	273-201744
50	1/1	0,5	Amber	8	273-201745
100	1/1	0,5	Amber	8	273-201746
250	2/1	1	Amber	8	273-201747
500	5/1	2,5	Amber	8	273-001748
1000	10/1	5	Amber	8	273-001749

WEIGHING ELEMENTS

WEIGHING ELEMENTS

WATCH GLASSES, SODA, FUSED EDGES, DIN 12431



Ø (mm)	PACK (U.)	ART. NO.
40	10	0381182040
50	10	0381182050
60	10	0381182060
70	10	0381182070
80	10	0381182080
100	10	0381182100
120	10	0381182120
150	10	0381182150
200	10	0381182200

WEIGHING BOTTLES INTERNAL LID



Borosilicate glass 3.3. Column Dim. ØxH (mm) refers to complete weighing bottle dimensions.

DESCRIPTION	DIM. ØxH (mm)	PACK (U.)	ART. NO.
Complete	28x30	1	073-000829
Interchangeable lid. Male: 29/10	28x30	1	073-000830
Body, 35 mm length. Female: 29/10	28x30	1	073-000831
Complete	44x40	1	073-000832
Interchangeable lid. Male: 40/12	44x40	1	073-000833
Body, 40 mm length. Female: 40/12	44x40	1	073-000834
Complete	50x40	1	073-000835
Interchangeable lid. Male: 45/12	50x40	1	073-000836
Body, 40 mm length. Female: 45/12	50x40	1	073-000837
Complete	60x40	1	073-000838
Interchangeable lid. Male: 55/12	60x40	1	073-000839
Body, 40 mm length. Female: 55/12	60x40	1	073-000840

WEIGHING FUNNELS



CAP. (ml)	Ø STEM (mm)	PACK (U.)	ART. NO.
1	6	1	073-008531
3	7	1	073-000853
6	10	1	073-000854
10	12	1	073-000855
20	12	1	073-008520
50	12	1	073-085550

SCHARLAU PREMIUM MINIREACTORS

SCHARLAU PREMIUM MINIREACTORS

Scharlau premium minireactors are indicated for liquid phase synthesis and are the best choice for research applications as well as for education.

Made of borosilicate glass 3.3, some of the most remarkable features are:

- Color touch screen
- Control unit allows to preset up to 10 programs of 6 segment each one, where temperature gradient and stirring could be controlled
- USB port for data dump
- Stirring seal with motor quick coupling and electronic regulation of velocity for the automatic maintaining of it despite of changes of charge or viscosity
- Standard glass lid of 5 mouths, totally customizable. Free grease closure system based on a FEP/silicone o-ring with a centering PTFE ring
- All the materials are inert and resistant (glass, PTFE, Hastelloy®)

We currently have 2 different models:

Premium Minireactor MR

Our jacketed minireactors incorporates a PTFE key for the drainage with zero dead volume, for a completely homogeneous reaction. Also, the controller unit comes with a safety drip tray for accidental spills.

Premium Minireactor HME-R

Aluminum block for a homogeneous and quick heating of the glass reactor, with lateral groove for the visual control of the reaction. The range of work of heating plate range between 15°C up to 250°C. Also, this setup comes with a PT100 probe.

Another feature is the autotuning system, which allows to set up custom-made heating gradients for each program, avoiding the overheating of the solution during the reaction.

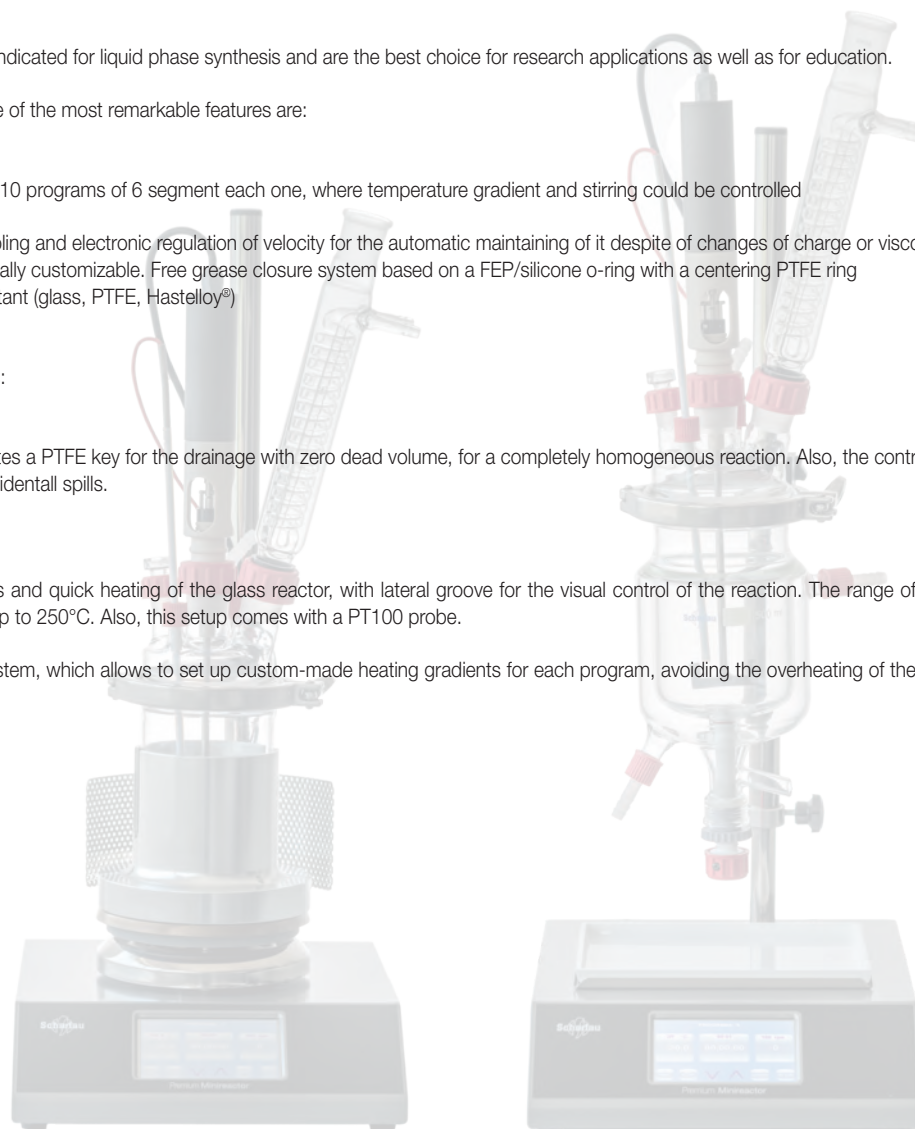

COMPACT PREMIUM MINIREACTORS FOR SYNTHESIS IN LIQUID PHASE WITH MECHANICAL STIRRING AND ELECTRICAL HEATING



- Aluminium block for fast, homogenous heating with groove for internal visibility.
- Electrical heating from +15 to 250°C with PT100 sensor.
- Reaction vessels from 50 ml to 2 litres.
- Mechanical stirring.
- Stirrer bearing with quick motor coupling.
- Maintains exact speed under changing loads or viscosity.
- Heavy-duty stainless-steel telescopic stand.
- Standard 5 neck glass lid customizable on request.
- FEP encapsulated silicone O-ring, grease free, with self-centering PTFE collar.
- Inert and chemical resistant materials in contact with the reaction product (Glass, PTFE, Hastelloy® stirring shaft).
- Easy internal access.
- Quick release tool-free vessel clamp made of stainless steel.
- USB port for datalogging.
- Colour touch screen.
- Autotuning function.

Technical specifications:

- Temperature range: ambient +15°C to 250°C (0,5 °C intervals)
- Power: 800 W (hotplate) and 50 W (stirrer)
- Stirring speed range: 100 to 700 rpm* controlled by microprocessor (25 rpm intervals)
- Up to 10 programs of 6 segments (Temperature, speed and time)
- Pressure range: from 5mb to 0,7 bar overpressure
- Colour touch screen with real-time temperature and stirring graphics
- Overheating protection: automatic safety shutdown
- USB port for datalogging
- Dimensions: 276x315 mm
- Minimum height: 635 mm (885 mm for 5 l minireactor)
- Maximum height: 935 mm (1150 mm for 5 l minireactor)
- Power supply: 220 V, 50-60 Hz

* Available lower speed range on request (1-400 rpm).

NOTE: The condenser is exclusively used as a photo prop and is not included in the minireactor set up.

DESCRIPTION	Ø JOINT (")	PACK (U.)	ART. NO.
Premium minireactor with mechanical stirring and heating of 50 ml	2,5	1	PHMERO/50
Premium minireactor with mechanical stirring and heating of 100 ml	2,5	1	PHMERO/100
Premium minireactor with mechanical stirring and heating of 250 ml	3	1	PHMERO/250
Premium minireactor with mechanical stirring and heating of 500 ml	3	1	PHMER/5003
Premium minireactor with mechanical stirring and heating of 500 ml	4	1	PHMER/5004
Premium minireactor with mechanical stirring and heating of 1000 ml	4	1	PHMER/1000
Premium minireactor with mechanical stirring and heating of 2000 ml	4	1	PHMER/2000



PREMIUM MINIREACTOR WITH MECHANICAL STIRRING AND JACKETED REACTION VESSEL



Jacketed reaction vessels from 50 ml to 2 litres.
 Temperature control through external equipment (heating or cooling).
 Stirring speed and time settings.
 Zero dead space drain PTFE stopcock.
 Safety drip tray for accidental spills.
 Mechanical stirring:
 Stirrer bearing with quick motor coupling.
 It maintains exact speed under changing loads or viscosity.
 Heavy-duty stainless-steel telescopic stand.
 Standard 5 neck glass lid customisable on request.
 FEP encapsulated silicone O-ring, grease free, with self-centering PTFE collar.
 Inert and chemical resistant materials in contact with the reaction product (Glass, PTFE, Hastelloy® stirring shaft).
 Easy internal access.
 Quick release tool-free vessel clamp made of stainless steel.
 USB port for datalogging.
 Colour touch screen.
 Autotuning function.

Technical specifications:

- Temperature range: depending on the circulating bath to which it is connected
- Power: 50 W (stirrer)
- Stirring speed range: 100 to 700 rpm* controlled by microprocessor (25 rpm intervals)
- Up to 10 programs of 6 segments (Speed and time). Temperature: only register
- Pressure range: from 5 MB to 0,7 bar overpressure
- Colour touch screen with real-time temperature and stirring graphics
- Overheating protection: automatic safety shutdown
- USB port for datalogging
- Dimensions: 276x315 mm
- Minimum height: 635 mm (885 mm for 5 l minireactor)
- Maximum height: 935 mm (1150 mm for 5 l minireactor)
- Power supply: 220 V, 50-60 Hz

* Available lower speed range on request (1-400 rpm).

** This model does not include temperature probe.

NOTE: The condenser is exclusively used as a photo prop and is not included in the minireactor set up.

DESCRIPTION	Ø JOINT (")	PACK (U.)	ART. NO.
Premium minireactor with mechanical stirring and jacketed reaction vessel of 50 ml	2,5	1	PMR000/50
Premium minireactor with mechanical stirring and jacketed reaction vessel of 100 ml	2,5	1	PMR000/100
Premium minireactor with mechanical stirring and jacketed reaction vessel of 250 ml	3	1	PMR000/250
Premium minireactor with mechanical stirring and jacketed reaction vessel of 500 ml	3	1	PMR00/5003
Premium minireactor with mechanical stirring and jacketed reaction vessel of 500 ml	4	1	PMR00/5004
Premium minireactor with mechanical stirring and jacketed reaction vessel of 1000 ml	4	1	PMR00/1000
Premium minireactor with mechanical stirring and jacketed reaction vessel of 2000 ml	4	1	PMR00/2000



COMPONENTS FOR PREMIUM COMPACT MINIREACTOR VESSELS

COMMON COMPONENTS FOR PREMIUM MINIREACTORS



DESCRIPTION	PACK (U.)	ART. NO.
Mechanical stirrer with aluminium case and 2 mts cable (40 - 400 rpm)	1	50PMRMOT52
Mechanical stirrer with aluminium case and 2 mts cable (100 - 700 rpm)	1	50PMRMOT53
Control panel with touch screen and protection tray for splashes	1	500-00PMR1
Control panel with touch screen and heating plate	1	500-0PHMER
Stainless Steel traction piece for stirring shaft	1	0ARRASMINI
Temperature probe Pt100 with 3 pins connector	1	00PMRPT100
Telescopic stand 25 mm Ø	1	500TUBTELE
Telescopic stand 25 mm Ø. Longer version	1	50GTUBTELE

ALUMINIUM HEATING BLOCKS FOR PREMIUM REACTORS



DESCRIPTION	PACK (U.)	ART. NO.
Aluminium heating block for 50 ml reactor	1	50PMRCAL50
Aluminium heating block for 100 ml reactor	1	5PMRCAL100
Aluminium heating block for 250 ml reactor	1	5PMRCAL250
Aluminium heating block for 500 ml reactor	1	5PMRCAL500
Aluminium heating block for 1000 ml reactor	1	PMRCAL1000
Aluminium heating block for 2000 ml reactor	1	PMRCAL2000

GLASS REACTION VESSELS



DESCRIPTION	PACK (U.)	ART. NO.
Glass reaction vessel 50 ml with joint 2"1/2	1	500-0MRR50
Glass reaction vessel 100 ml with joint 2"1/2	1	500-MRR100
Glass reaction vessel 250 ml with joint 3"	1	500-MRR250
Glass reaction vessel 500 ml with joint 3"	1	500MRR5003
Glass reaction vessel 500 ml with joint 4"	1	500MRR5004
Glass reaction vessel 1000 ml with joint 4"	1	50MRR10004
Glass reaction vessel 2000 ml with joint 4"	1	50MRR20004

GLASS REACTION VESSELS JACKETED WITH DRAIN VALVE



DESCRIPTION	PACK (U.)	ART. NO.
Glass reaction vessel jacketed with drain valve 50 ml	1	500MRRTD50
Glass reaction vessel jacketed with drain valve 100 ml	1	BRMRRTD100
Glass reaction vessel jacketed with drain valve 250 ml	1	BRMRRTD250
Glass reaction vessel jacketed with drain valve 500 ml with joint 3"	1	5MRRTD5003
Glass reaction vessel jacketed with drain valve 500 ml with joint 4"	1	5MRRTD5004
Glass reaction vessel jacketed with drain valve 1000 ml with joint 4"	1	5MRRTD1000
Glass reaction vessel jacketed with drain valve 2000 ml with joint 4"	1	5MRRTD2000

GLASS LIDS WITH 5 NECKS



DESCRIPTION	PACK (U.)	ART. NO.
Flange lid 2"1/2 with 5 necks	1	500-0MRT25
Flange lid 3" with 5 necks	1	500-00MRT3
Flange lid 4" with 5 necks C-SAV-29 (Rodaviss)	1	500-00MRT4

O-RING MADE OF SILICONE AND PTFE



DESCRIPTION	PACK (U.)	ART. NO.
O-ring 2" 1/2 made of silicone and PTFE	1	500-0MRJ25
O-ring 3" made of silicone and PTFE	1	500-00MRJ3
O-ring 4" made of silicone and PTFE	1	500-00MRJ4

STIRRER BEARING FOR PREMIUM MINIREACTORS



DESCRIPTION	PACK (U.)	ART. NO.
PEEK stirrer bearing for shaft 6 mm Ø and NS 14,5	1	CIAGPEEK14
PEEK stirrer bearing for shaft 6 mm Ø and NS 29	1	CIAGPEEK29

STIRRING SHAFT ANCHOR SHAPED MADE OF HASTELLOY® FOR PREMIUM MINIREACTORS



DESCRIPTION	PACK (U.)	ART. NO.
Hastelloy® stirring shaft for reaction vessel 50 ml	1	500-PMRA50
Hastelloy® stirring shaft for reaction vessel 100 ml	1	500PMRA100
Hastelloy® stirring shaft for reaction vessel 250 ml	1	500PMRA250
Hastelloy® stirring shaft for reaction vessel 500 ml flat flange 3"	1	500PMRA500
Hastelloy® stirring shaft for reaction vessel 500 ml flat flange 4"	1	50PMRA5004
Hastelloy® stirring shaft for reaction vessel 1000 ml	1	50PMRA1000
Hastelloy® stirring shaft for reaction vessel 2000 ml	1	50PMRA2000

FLANGE CLOSURE AND SUPPORTING DEVICE MADE OF STAINLESS STEEL



DESCRIPTION	PACK (U.)	ART. NO.
Flange closure and supporting device for 2"1/2	1	500-0MRS25
Flange closure and supporting device for 3"	1	500-00MRS3
Flange closure and supporting device for 4"	1	500-00MRS4

CONSUMABLES

ANAEROBIOSIS	210
CONTAINERS AND FLASKS	211
DISPENSATION	212
FILTRATION	213
INDICATOR PAPERS	228
PIPETTES	229
PLATES	233
SAFETY	235
TIMERS	237
TUBES	238



ANAEROBIOSIS

ANAEROBIOSIS

ANAEROBIC JAR



Anaerobic jar of 2.5 litres.

DESCRIPTION	PACK (U.)	ART. NO.
2.5 litres	1	064-AG0P25

ATMOSPHERE GENERATOR SACHETS

Atmosphere generators and anaerobic indicators. Three different atmosphere generators available. Do not require the addition of water or a catalyst.

DESCRIPTION	PACK (U.)	ART. NO.
Anaerobic atmosphere generator sachets	10	230-096124
Microaerophilic atmosphere generator sachets	10	230-096125
CO ₂ atmosphere generator sachets for capnophilic bacteria	10	230-096126
Anaerobios indicators strips	50	230-096118

CONTAINERS AND FLASKS

CONTAINERS AND FLASKS

CYLINDRICAL FLASKS (DUCHESS TYPE)



Duchess type flasks, cylindrical with wide neck, translucent white, made of high density polyethylene. For the collection, conservation and storage of samples. With black screw cap and translucent pressure shutter to ensure airtightness and product conservation.

CAP. (ml)	MOUTH Ø (mm)	Ø x H (mm)	PACK (U.)	ART. NO.
60	46	57x45	500	DUQ0000060
100	46	59x60	350	DUQ0000100
125	46	59x70	300	DUQ0000125
250	51	67x98	280	DUQ0000250
500	62	80x112	160	DUQ0000500
1000	86	102x151	90	DUQ0001000
2000	86	118x227	64	DUQ0002000

THREADED CONTAINERS FOR SAMPLES

PP urine containers with PE cap. Writing surface on the side. Wide thermal and chemical resistance. The sterile models have been irradiated and are supplied in an individual bag. Two capacities available. The code PUC1501000, is delivered with the cap without threading.



PSC0603000



PSC0603001



PUC1501000



PUC1501001

DESCRIPTION	CAP. (ml)	EXT. DIM. Ø x H (mm)	STERILE	PACK (U.)	ART. NO.
With assembled cap	60	38x65	No	600	PSC0603000
Sterile with assembled cap	60	38x65	Yes	400	PSC0603001
With separate cap	150	58x72	No	500	PUC1501000
Sterile with assembled cap	150	58x72	Yes	250	PUC1501001



DISPENSATION

DISPENSERS



Economical, resistant dispensers, easy to adjust volume and dosing accuracy thanks to an optimised pump system. Compatible with practically all solvents and acids.

Exceptions: solutions containing hydrofluoric acid, crystallising solutions containing or forming solid materials.

Resistant to autoclave sterilisation at 121°C. Suitable for acids and bases. Removable for easy cleaning. Supplied with calibration certificate, 3 PP adapters, tube, a tool to facilitate assembly and disassembly of the dispenser and the operations manual.

RANGE (ml)	SUBDIVISIONS (ml)	INACCURACY (vk)	IMPRECISION (cv)	GL THREAD	ADAPTER GL	PACK (U.)	ART. NO.
0,25 to 2,5	0,05	±0,6 %	≤0,1 %	32	28, 40, 45	1	033-065.01
0,5 to 5	0,10	±0,5 %	≤0,1 %	32	28, 40, 45	1	033-065.02
1 to 10	0,20	±0,5 %	≤0,1 %	32	28, 40, 45	1	033-065.03
2,5 to 25	0,50	±0,5 %	≤0,1 %	45	32, 38, 38/32	1	033-065.04
5 to 50	1,00	±0,5 %	≤0,1 %	45	32, 38, 38/32	1	033-065.05

FILTRATION

Qualitative and quantitative filter paper PAGE 213
 Glass microfibre and quartz microfibre filters PAGE 221
 Soxhlet cellulose extraction thimbles PAGE 222
 Reams PAGE 223
 Membranes PAGE 224
 Syringe filters PAGE 225

FILTRATION: QUALITATIVE AND QUANTITATIVE FILTER PAPER

Filtration is a common technique in laboratories and widely used in many analytical processes. In areas such as the food and beverage industry, pharmaceutical industry, chemical industry, environmental monitoring, water monitoring and research, filtration plays an important role.

The Scharlau range of laboratory filters consists of high quality products using only the best new materials. Our line of filters is comprised of laboratory quantitative and qualitative filters papers, reams, extraction thimbles, quartz microfibre filters and glass microfibre filters, syringe filters, membranes filters for mobile phase and membrane filters for microbiology. The lot number is detailed on the boxes containing our filters.

The certificate of conformity is available on request.

The table here below is a guide to the filtration rates of our filter papers:

		FILTRATION SPEED							
TYPE OF PAPER		VERY-SLOW FILTRATION	SLOW FILTRATION	MEDIUM FILTRATION		FAST FILTRATION	VERY-FAST FILTRATION		
QUANTITATIVE	Quantitative ashless	WAT	WAS	WAP	WAM	WAG	WAF	WAE	
	Quantitative ashless hardened		WASH		WAMH		WAFH		
	Qualitative analytical grade	LAS	LAP	LAT	LAM	LAG	LAF		
QUALITATIVE	Qualitative general use				STAM		STAE	STAR	
	Qualitative general use creped						STAF		

QUANTITATIVE ASHLESS FILTER PAPERS

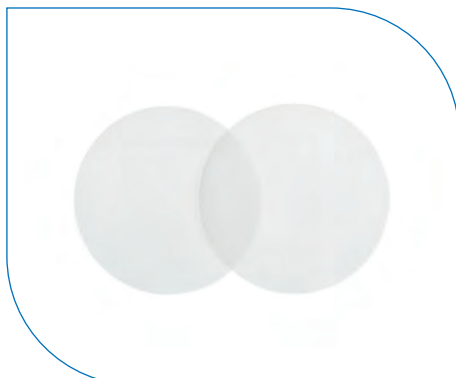

Filter papers for quantitative and gravimetric analysis and titration. Maximum cellulose purity, washed with acid and ashes content below 0,01%.

WAFH GRADE, 85 g/m², FAST FILTRATION, HARDENED. SCHARLAU

Ø (mm)	TYPICAL RETENTION (µm)	DISC/FOLDED	PACK (U.)	ART. NO.
47	25-30	Disc	100	CFIWAFH047
50	25-30	Disc	100	CFIWAFH050
55	25-30	Disc	100	CFIWAFH055
70	25-30	Disc	100	CFIWAFH070
90	25-30	Disc	100	CFIWAFH090
110	25-30	Disc	100	CFIWAFH110
125	25-30	Disc	100	CFIWAFH125
150	25-30	Disc	100	CFIWAFH150
185	25-30	Disc	100	CFIWAFH185
240	25-30	Disc	100	CFIWAFH240
110	25-30	Folded	100	CF2WAFH110
125	25-30	Folded	100	CF2WAFH125
150	25-30	Folded	100	CF2WAFH150
185	25-30	Folded	100	CF2WAFH185
240	25-30	Folded	100	CF2WAFH240
270	25-30	Folded	100	CF2WAFH270

WAMH GRADE, 85 g/m², MEDIUM TO SLOW FILTRATION, HARDENED. SCHARLAU

Ø (mm)	TYPICAL RETENTION (µm)	DISC/FOLDED	PACK (U.)	ART. NO.
47	15-17	Disc	100	CFIWAMH047
50	15-17	Disc	100	CFIWAMH050
55	15-17	Disc	100	CFIWAMH055
70	15-17	Disc	100	CFIWAMH070
90	15-17	Disc	100	CFIWAMH090
110	15-17	Disc	100	CFIWAMH110
125	15-17	Disc	100	CFIWAMH125
150	15-17	Disc	100	CFIWAMH150
185	15-17	Disc	100	CFIWAMH185
240	15-17	Disc	100	CFIWAMH240
110	15-17	Folded	100	CF2WAMH110
125	15-17	Folded	100	CF2WAMH125
150	15-17	Folded	100	CF2WAMH150
185	15-17	Folded	100	CF2WAMH185
240	15-17	Folded	100	CF2WAMH240
270	15-17	Folded	100	CF2WAMH270

WASH GRADE, 85 g/m², VERY SLOW FILTRATION, HARDENED. SCHARLAU

Ø (mm)	TYPICAL RETENTION (µm)	DISC/FOLDED	PACK (U.)	ART. NO.
47	2-4	Disc	100	CFIWASH047
50	2-4	Disc	100	CFIWASH050
55	2-4	Disc	100	CFIWASH055
70	2-4	Disc	100	CFIWASH070
90	2-4	Disc	100	CFIWASH090
110	2-4	Disc	100	CFIWASH110
125	2-4	Disc	100	CFIWASH125
150	2-4	Disc	100	CFIWASH150
185	2-4	Disc	100	CFIWASH185
240	2-4	Disc	100	CFIWASH240
110	2-4	Folded	100	CF2WASH110
125	2-4	Folded	100	CF2WASH125
150	2-4	Folded	100	CF2WASH150
185	2-4	Folded	100	CF2WASH185
240	2-4	Folded	100	CF2WASH240
270	2-4	Folded	100	CF2WASH270

WAE GRADE, 85 g/m², EXTRA-FAST FILTRATION. SCHARLAU

Ø (mm)	TYPICAL RETENTION (µm)	DISC/FOLDED	PACK (U.)	ART. NO.
47	25-35	Disc	100	CFIWAE0047
50	25-35	Disc	100	CFIWAE0050
55	25-35	Disc	100	CFIWAE0055
70	25-35	Disc	100	CFIWAE0070
90	25-35	Disc	100	CFIWAE0090
110	25-35	Disc	100	CFIWAE0110
125	25-35	Disc	100	CFIWAE0125
150	25-35	Disc	100	CFIWAE0150
185	25-35	Disc	100	CFIWAE0185
240	25-35	Disc	100	CFIWAE0240
320	25-35	Disc	100	CFIWAE0320
110	25-35	Folded	100	CF2WAE0110
125	25-35	Folded	100	CF2WAE0125
150	25-35	Folded	100	CF2WAE0150
185	25-35	Folded	100	CF2WAE0185
240	25-35	Folded	100	CF2WAE0240
270	25-35	Folded	100	CF2WAE0270

WAF GRADE, 85 g/m², FAST FILTRATION. SCHARLAU

Ø (mm)	TYPICAL RETENTION (µm)	DISC/FOLDED	PACK (U.)	ART. NO.
47	25-30	Disc	100	CFIWAF0047
50	25-30	Disc	100	CFIWAF0050
55	25-30	Disc	100	CFIWAF0055
70	25-30	Disc	100	CFIWAF0070
90	25-30	Disc	100	CFIWAF0090
110	25-30	Disc	100	CFIWAF0110
125	25-30	Disc	100	CFIWAF0125
150	25-30	Disc	100	CFIWAF0150
185	25-30	Disc	100	CFIWAF0185
240	25-30	Disc	100	CFIWAF0240
110	25-30	Folded	100	CF2WAF0110
125	25-30	Folded	100	CF2WAF0125
150	25-30	Folded	100	CF2WAF0150
185	25-30	Folded	100	CF2WAF0185
240	25-30	Folded	100	CF2WAF0240
270	25-30	Folded	100	CF2WAF0270

WAG GRADE, 85 g/m², FAST FILTRATION. SCHARLAU

Ø (mm)	TYPICAL RETENTION (µm)	DISC/FOLDED	PACK (U.)	ART. NO.
47	20-25	Disc	100	CFIWAG0047
50	20-25	Disc	100	CFIWAG0050
55	20-25	Disc	100	CFIWAG0055
70	20-25	Disc	100	CFIWAG0070
90	20-25	Disc	100	CFIWAG0090
110	20-25	Disc	100	CFIWAG0110
125	20-25	Disc	100	CFIWAG0125
150	20-25	Disc	100	CFIWAG0150
185	20-25	Disc	100	CFIWAG0185
240	20-25	Disc	100	CFIWAG0240
320	20-25	Disc	100	CFIWAG0320
110	20-25	Folded	100	CF2WAG0110
125	20-25	Folded	100	CF2WAG0125
150	20-25	Folded	100	CF2WAG0150
185	20-25	Folded	100	CF2WAG0185
240	20-25	Folded	100	CF2WAG0240
270	20-25	Folded	100	CF2WAG0270
320	20-25	Folded	100	CF2WAG0320

WAM GRADE, 85 g/m², MEDIUM TO SLOW FILTRATION. SCHARLAU

Ø (mm)	TYPICAL RETENTION (µm)	DISC/FOLDED	PACK (U.)	ART. NO.
47	14-18	Disc	100	CFIWAM0047
50	14-18	Disc	100	CFIWAM0050
55	14-18	Disc	100	CFIWAM0055
70	14-18	Disc	100	CFIWAM0070
90	14-18	Disc	100	CFIWAM0090
110	14-18	Disc	100	CFIWAM0110
125	14-18	Disc	100	CFIWAM0125
150	14-18	Disc	100	CFIWAM0150
185	14-18	Disc	100	CFIWAM0185
240	14-18	Disc	100	CFIWAM0240
110	14-18	Folded	100	CF2WAM0110
125	14-18	Folded	100	CF2WAM0125
150	14-18	Folded	100	CF2WAM0150
185	14-18	Folded	100	CF2WAM0185
240	14-18	Folded	100	CF2WAM0240
270	14-18	Folded	100	CF2WAM0270
320	14-18	Folded	100	CF2WAM0320

WAP GRADE, 70 g/m², MEDIUM TO SLOW FILTRATION. SCHARLAU

Ø (mm)	TYPICAL RETENTION (µm)	DISC/FOLDED	PACK (U.)	ART. NO.
47	7-9	Disc	100	CFIWAP0047
50	7-9	Disc	100	CFIWAP0050
55	7-9	Disc	100	CFIWAP0055
70	7-9	Disc	100	CFIWAP0070
90	7-9	Disc	100	CFIWAP0090
110	7-9	Disc	100	CFIWAP0110
125	7-9	Disc	100	CFIWAP0125
150	7-9	Disc	100	CFIWAP0150
185	7-9	Disc	100	CFIWAP0185
240	7-9	Disc	100	CFIWAP0240
320	7-9	Disc	100	CFIWAP0320
110	7-9	Folded	100	CF2WAP0110
125	7-9	Folded	100	CF2WAP0125
150	7-9	Folded	100	CF2WAP0150
185	7-9	Folded	100	CF2WAP0185
240	7-9	Folded	100	CF2WAP0240
270	7-9	Folded	100	CF2WAP0270
320	7-9	Folded	100	CF2WAP0320

WAS GRADE, 100 g/m², SLOW FILTRATION. SCHARLAU

Ø (mm)	TYPICAL RETENTION (µm)	DISC/FOLDED	PACK (U.)	ART. NO.
47	2-4	Disc	100	CFIWAS0047
50	2-4	Disc	100	CFIWAS0050
55	2-4	Disc	100	CFIWAS0055
70	2-4	Disc	100	CFIWAS0070
90	2-4	Disc	100	CFIWAS0090
110	2-4	Disc	100	CFIWAS0110
125	2-4	Disc	100	CFIWAS0125
150	2-4	Disc	100	CFIWAS0150
185	2-4	Disc	100	CFIWAS0185
240	2-4	Disc	100	CFIWAS0240
110	2-4	Folded	100	CF2WAS0110
125	2-4	Folded	100	CF2WAS0125
150	2-4	Folded	100	CF2WAS0150
185	2-4	Folded	100	CF2WAS0185
240	2-4	Folded	100	CF2WAS0240
270	2-4	Folded	100	CF2WAS0270
320	2-4	Folded	100	CF2WAS0320

WAT GRADE, 100 g/m², VERY SLOW FILTRATION. SCHARLAU

Ø (mm)	TYPICAL RETENTION (µm)	DISC/FOLDED	PACK (U.)	ART. NO.
47	1-3	Disc	100	CFIWAT0047
50	1-3	Disc	100	CFIWAT0050
55	1-3	Disc	100	CFIWAT0055
70	1-3	Disc	100	CFIWAT0070
90	1-3	Disc	100	CFIWAT0090
110	1-3	Disc	100	CFIWAT0110
125	1-3	Disc	100	CFIWAT0125
150	1-3	Disc	100	CFIWAT0150
185	1-3	Disc	100	CFIWAT0185
240	1-3	Disc	100	CFIWAT0240
320	1-3	Disc	100	CFIWAT0320
110	1-3	Folded	100	CF2WAT0110
125	1-3	Folded	100	CF2WAT0125
150	1-3	Folded	100	CF2WAT0150
185	1-3	Folded	100	CF2WAT0185
240	1-3	Folded	100	CF2WAT0240
270	1-3	Folded	100	CF2WAT0270
320	7-9	Folded	100	CF2WAP0320

QUALITATIVE LOW ASH FILTER PAPERS



Filter papers for qualitative analysis, identifies detained. High cellulose quality and ashes content below 0,07%.

LAF GRADE, 130 g/m², FAST FILTRATION. SCHARLAU

Ø (mm)	TYPICAL RETENTION (µm)	DISC/FOLDED	PACK (U.)	ART. NO.
47	25-30	Disc	100	CFILAF0047
55	25-30	Disc	100	CFILAF0055
70	25-30	Disc	100	CFILAF0070
90	25-30	Disc	100	CFILAF0090
110	25-30	Disc	100	CFILAF0110
125	25-30	Disc	100	CFILAF0125
150	25-30	Disc	100	CFILAF0150
185	25-30	Disc	100	CFILAF0185
240	25-30	Disc	100	CFILAF0240
125	25-30	Folded	100	CF2LAF0125
150	25-30	Folded	100	CF2LAF0150
185	25-30	Folded	100	CF2LAF0185
240	25-30	Folded	100	CF2LAF0240
320	25-30	Folded	100	CF2LAF0320

LAG GRADE, 88 g/m², FAST FILTRATION. SCHARLAU

Ø (mm)	TYPICAL RETENTION (µm)	DISC/FOLDED	PACK (U.)	ART. NO.
47	20-25	Disc	100	CFILAG0047
55	20-25	Disc	100	CFILAG0055
70	20-25	Disc	100	CFILAG0070
90	20-25	Disc	100	CFILAG0090
110	20-25	Disc	100	CFILAG0110
125	20-25	Disc	100	CFILAG0125
150	20-25	Disc	100	CFILAG0150
185	20-25	Disc	100	CFILAG0185
240	20-25	Disc	100	CFILAG0240
320	20-25	Disc	100	CFILAG0320
90	20-25	Folded	100	CF2LAG0090
110	20-25	Folded	100	CF2LAG0110
125	20-25	Folded	100	CF2LAG0125
150	20-25	Folded	100	CF2LAG0150
185	20-25	Folded	100	CF2LAG0185
240	20-25	Folded	100	CF2LAG0240
320	20-25	Folded	100	CF2LAG0320



LAM GRADE, 87 g/m², MEDIUM TO SLOW FILTRATION. SCHARLAU

Ø (mm)	TYPICAL RETENTION (µm)	DISC/FOLDED	PACK (U.)	ART. NO.
47	10-15	Disc	100	CFILAM0047
50	10-15	Disc	100	CFILAM0050
55	10-15	Disc	100	CFILAM0055
70	10-15	Disc	100	CFILAM0070
90	10-15	Disc	100	CFILAM0090
110	10-15	Disc	100	CFILAM0110
125	10-15	Disc	100	CFILAM0125
150	10-15	Disc	100	CFILAM0150
185	10-15	Disc	100	CFILAM0185
240	10-15	Disc	100	CFILAM0240
90	10-15	Folded	100	CF2LAM0090
110	10-15	Folded	100	CF2LAM0110
125	10-15	Folded	100	CF2LAM0125
150	10-15	Folded	100	CF2LAM0150
185	10-15	Folded	100	CF2LAM0185
240	10-15	Folded	100	CF2LAM0240
320	10-15	Folded	100	CF2LAM0320

LAP GRADE, 80 g/m², SLOW FILTRATION. SCHARLAU

Ø (mm)	TYPICAL RETENTION (µm)	DISC/FOLDED	PACK (U.)	ART. NO.
47	2-4	Disc	100	CFILAP0047
50	2-4	Disc	100	CFILAP0050
55	2-4	Disc	100	CFILAP0055
70	2-4	Disc	100	CFILAP0070
90	2-4	Disc	100	CFILAP0090
110	2-4	Disc	100	CFILAP0110
125	2-4	Disc	100	CFILAP0125
150	2-4	Disc	100	CFILAP0150
185	2-4	Disc	100	CFILAP0185
240	2-4	Disc	100	CFILAP0240
320	2-4	Disc	100	CFILAP0320
90	2-4	Folded	100	CF2LAP0090
110	2-4	Folded	100	CF2LAP0110
125	2-4	Folded	100	CF2LAP0125
150	2-4	Folded	100	CF2LAP0150
185	2-4	Folded	100	CF2LAP0185
240	2-4	Folded	100	CF2LAP0240
320	2-4	Folded	100	CF2LAP0320

LAS GRADE, 80 g/m², VERY SLOW FILTRATION. SCHARLAU

Ø (mm)	TYPICAL RETENTION (µm)	DISC/FOLDED	PACK (U.)	ART. NO.
47	1-3	Disc	100	CFILAS0047
50	1-3	Disc	100	CFILAS0050
55	1-3	Disc	100	CFILAS0055
70	1-3	Disc	100	CFILAS0070
90	1-3	Disc	100	CFILAS0090
110	1-3	Disc	100	CFILAS0110
125	1-3	Disc	100	CFILAS0125
150	1-3	Disc	100	CFILAS0150
185	1-3	Disc	100	CFILAS0185
240	1-3	Disc	100	CFILAS0240
90	1-3	Folded	100	CF2LAS0090
110	1-3	Folded	100	CF2LAS0110
125	1-3	Folded	100	CF2LAS0125
150	1-3	Folded	100	CF2LAS0150
185	1-3	Folded	100	CF2LAS0185
240	1-3	Folded	100	CF2LAS0240
320	1-3	Folded	100	CF2LAS0320

LAT GRADE, 200 g/m², MEDIUM TO SLOW FILTRATION, THICK. SCHARLAU

Ø (mm)	TYPICAL RETENTION (µm)	DISC/FOLDED	PACK (U.)	ART. NO.
47	5-7	Disc	100	CFILAT0047
50	5-7	Disc	100	CFILAT0050
55	5-7	Disc	100	CFILAT0055
70	5-7	Disc	100	CFILAT0070
90	5-7	Disc	100	CFILAT0090
110	5-7	Disc	100	CFILAT0110
125	5-7	Disc	100	CFILAT0125
150	5-7	Disc	100	CFILAT0150
185	5-7	Disc	100	CFILAT0185
240	5-7	Disc	100	CFILAT0240
320	5-7	Disc	100	CFILAT0320

QUALITATIVE FILTER PAPERS FOR GENERAL USE (TECHNICAL GRADE)

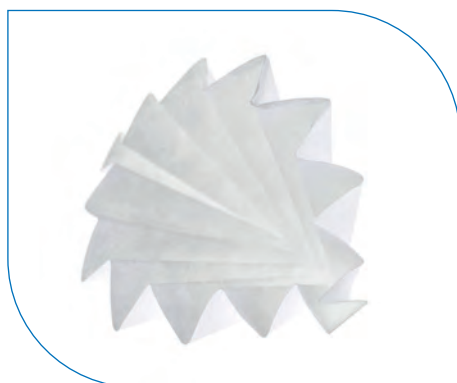

Filter papers for routine analysis. High quality cellulose and ashes content below 0,3%.

STAR GRADE, 160 g/m², EXTRA FAST FILTRATION, FOR GENERAL USE. SCHARLAU

Ø (mm)	TYPICAL RETENTION (µm)	DISC/FOLDED	PACK (U.)	ART. NO.
90	60-68	Disc	100	CFISTAR090
110	60-68	Disc	100	CFISTAR110
125	60-68	Disc	100	CFISTAR125
130	60-68	Disc	100	CFISTAR130
150	60-68	Disc	100	CFISTAR150
185	60-68	Disc	100	CFISTAR185
240	60-68	Disc	100	CFISTAR240
270	60-68	Disc	100	CFISTAR270
320	60-68	Disc	100	CFISTAR320
90	60-68	Folded	100	CF2STAR090
110	60-68	Folded	100	CF2STAR110
125	60-68	Folded	100	CF2STAR125
150	60-68	Folded	100	CF2STAR150
185	60-68	Folded	100	CF2STAR185
240	60-68	Folded	100	CF2STAR240
70	60-68	Folded	100	CF2STAR270
320	60-68	Folded	100	CF2STAR320

STAE GRADE, 80 g/m², EXTRA FAST FILTRATION, FOR GENERAL USE. SCHARLAU

Ø (mm)	TYPICAL RETENTION (µm)	DISC/FOLDED	PACK (U.)	ART. NO.
90	43-48	Disc	100	CFISTAE090
110	43-48	Disc	100	CFISTAE110
125	43-48	Disc	100	CFISTAE125
130	43-48	Disc	100	CFISTAE130
150	43-48	Disc	100	CFISTAE150
200	43-48	Disc	100	CFISTAE200
250	43-48	Disc	100	CFISTAE250
90	43-48	Folded	100	CF2STAE090
110	43-48	Folded	100	CF2STAE110
130	43-48	Folded	100	CF2STAE130
150	43-48	Folded	100	CF2STAE150
185	43-48	Folded	100	CF2STAE185
200	43-48	Folded	100	CF2STAE200
250	43-48	Folded	100	CF2STAE250
300	43-48	Folded	100	CF2STAE300

STAM GRADE, 75 g/m², MEDIUM TO FAST FILTRATION, FOR GENERAL USE. SCHARLAU



Ø (mm)	TYPICAL RETENTION (µm)	DISC/FOLDED	PACK (U.)	ART. NO.
90	14-22	Disc	100	CFISTAM090
110	14-22	Disc	100	CFISTAM110
125	14-22	Disc	100	CFISTAM125
130	14-22	Disc	100	CFISTAM130
150	14-22	Disc	100	CFISTAM150
185	14-22	Disc	100	CFISTAM185
240	14-22	Disc	100	CFISTAM240
320	14-22	Disc	100	CFISTAM320
90	14-22	Folded	100	CF2STAM090
110	14-22	Folded	100	CF2STAM110
125	14-22	Folded	100	CF2STAM125
150	14-22	Folded	100	CF2STAM150
185	14-22	Folded	100	CF2STAM185
240	14-22	Folded	100	CF2STAM240
320	14-22	Folded	100	CF2STAM320

STAF GRADE, 85 g/m², EXTRA FAST FILTRATION, FOR GENERAL USE. CREPED. SCHARLAU

Ø (mm)	TYPICAL RETENTION (µm)	DISC/FOLDED	PACK (U.)	ART. NO.
90	34-42	Disc	100	CFISTAF090
110	34-42	Disc	100	CFISTAF110
125	34-42	Disc	100	CFISTAF125
150	34-42	Disc	100	CFISTAF150
185	34-42	Disc	100	CFISTAF185
240	34-42	Disc	100	CFISTAF240
320	34-42	Disc	100	CFISTAF320
90	34-42	Folded	100	CF2STAF090
110	34-42	Folded	100	CF2STAF110
125	34-42	Folded	100	CF2STAF125
150	34-42	Folded	100	CF2STAF150
185	34-42	Folded	100	CF2STAF185
240	34-42	Folded	100	CF2STAF240
320	34-42	Folded	100	CF2STAF320
125	5-7	Disc	100	CFISTAS125
185	5-7	Disc	100	CFISTAS185
240	5-7	Disc	100	CFISTAS240
320	5-7	Disc	100	CFISTAS320



FILTRATION: GLASS MICROFIBRE AND QUARTZ MICROFIBRE FILTERS

GLASS MICROFIBRE FILTERS

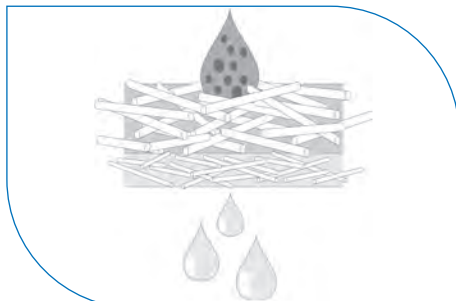

Due to its high retention of very fine particles and high loading capacity, the borosilicate glass microfibre is very resistant to aggressive environments and temperatures up to 500°C.

Commonly used for suspended solids in all types of water and effluent and filtration of particulates in water, algae and bacterial cultures, food and drink analyses.

TYPE GMFA. NO BINDING AGENTS

Ø (mm)	PARTICLE RETENTION IN LIQUID (µm)	WEIGHT (g/m ³)	THICKNESS (mm)	PACK (U.)	ART. NO.
24	1,6	52	0,2	100	GMFA-50024
35	1,6	52	0,2	100	GMFA-50035
47	1,6	52	0,2	100	GMFA-50047
90	1,6	52	0,2	100	GMFA-50090
150	1,6	52	0,2	100	GMFA-50150

TYPE GMFB. NO BINDING AGENTS

Ø (mm)	PARTICLE RETENTION IN LIQUID (µm)	WEIGHT (g/m ³)	THICKNESS (mm)	PACK (U.)	ART. NO.
24	1,0	143	0,7	50	GMFB143024
47	1,0	143	0,7	50	GMFB143047
90	1,0	143	0,7	50	GMFB143090
150	1,0	143	0,7	50	GMFB143150

TYPE GMFC. NO BINDING AGENTS

Ø (mm)	PARTICLE RETENTION IN LIQUID (µm)	WEIGHT (g/m ³)	THICKNESS (mm)	PACK (U.)	ART. NO.
24	1,2	52	0,25	100	GMFC-52024
35	1,2	52	0,25	100	GMFC-52035
47	1,2	52	0,25	100	GMFC-52047
90	1,2	52	0,25	100	GMFC-52090
150	1,2	52	0,25	100	GMFC-52150

TYPE GMFD. NO BINDING AGENTS

Ø (mm)	PARTICLE RETENTION IN LIQUID (µm)	WEIGHT (g/m ³)	THICKNESS (mm)	PACK (U.)	ART. NO.
24	2,7	120	0,53	100	GMFD120024
47	2,7	120	0,53	100	GMFD120047
90	2,7	120	0,53	100	GMFD120090
150	2,7	120	0,53	100	GMFD-12150

TYPE GMFF. NO BINDING AGENTS

Ø (mm)	PARTICLE RETENTION IN LIQUID (µm)	WEIGHT (g/m ³)	THICKNESS (mm)	PACK (U.)	ART. NO.
24	0,7	75	0,45	100	GMFF-75024
37	0,7	75	0,45	100	GMFF-75037
47	0,7	75	0,45	100	GMFF-75047
90	0,7	75	0,45	100	GMFF-75090

TYPE GMFG. NO BINDING AGENTS

Ø (mm)	PARTICLE RETENTION IN LIQUID (µm)	WEIGHT (g/m ³)	THICKNESS (mm)	PACK (U.)	ART. NO.
37	1,5	65	0,28	100	GMFG-65037
47	1,5	65	0,28	100	GMFG-65047

QUARTZ MICROFIBRE FILTERS



MFQ quartz microfibre disc, resistant up to 900°C, $\approx 85 \text{ g/m}^2$. Suitable for air sampler PM10. 99,95% efficiency in retaining particles 1 to 3 microns. Trace elements analysis available.

\varnothing (mm)	PARTICLE RETENTION IN LIQUID (μm)	PACK (U.)	ART. NO.
37	$\approx 1,5$	50	MFQ-85T037
47	$\approx 1,5$	50	MFQ-85T047
90	$\approx 1,5$	50	MFQ-85T090
150	$\approx 1,5$	50	MFQ-85T150

FILTRATION: SOXHLET CELLULOSE EXTRACTION THIMBLES

CELLULOSE EXTRACTION THIMBLES

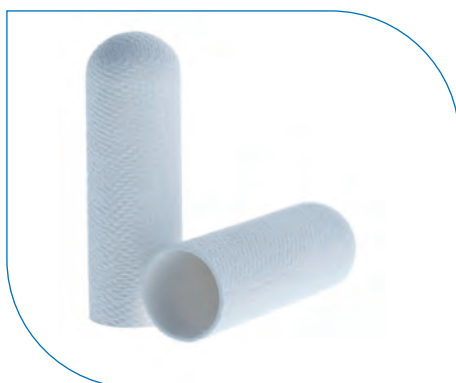

The extraction thimbles are made of high-purity alpha cellulose liners. Usually used with the Soxhlet extraction technique, for extractions of lipid compounds, from solid and semi-solid samples by means of solvents. Diameter tolerance $\pm 3 \text{ mm}$, and $\pm 10 \text{ mm}$ height tolerance. Wall thickness of 1,5 mm and ashes content less than 0,2%. The thimble range is completed with models fitted to automated Soxhlet extractor manufacturers.

STANDARD CELLULOSE THIMBLES

DIM. INNER \varnothing x LENGTH (mm)	PARTICLE RETENTION IN LIQUID (μm)	PACK (U.)	ART. NO.
10x50	Nom. 8-15	25	CT32510X50
19x90	Nom. 8-15	25	CT32519x90
20x80	Nom. 8-15	25	CT32520X80
22x100	Nom. 8-15	25	CT32522100
25x60	Nom. 8-15	25	CT32525X60
25x80	Nom. 8-15	25	CT32525X80
26x100	Nom. 8-15	25	CT32526100
26x60	Nom. 8-15	25	CT32526X60
28x100	Nom. 8-15	25	CT32528100
28x120	Nom. 8-15	25	CT32528120
30x100	Nom. 8-15	25	CT32530100
30x80	Nom. 8-15	25	CT32530X80
30x95	Nom. 8-15	25	CT32530X95
33x100	Nom. 8-15	25	CT32533100
33x118	Nom. 8-15	25	CT32533118
35x120	Nom. 8-15	25	CT32535120
35x150	Nom. 8-15	25	CT32535150
40x150	Nom. 8-15	25	CT32540150
48x145	Nom. 8-15	25	CT32548145

See **Soxhlet extractors** in **GLASSWARE**.



GLASS EXTRACTION THIMBLES



Thimbles made of 100% borosilicate glass microfibre, chemically resistant to most solvents and reagents. Resistant to high temperatures (500°C). Suitable when the solvents present are incompatible with cellulose cartridges. Used for the analysis of dust particles and aerosols in gas streams.

DIM. INNER ØxLENGTH (mm)	PARTICLE RETENTION IN LIQUID (µm)	PACK (U.)	ART. NO.
10x50	Nom. 0,5	25	MGT3210X50
16x50	Nom. 0,5	25	MGT3216X50
22x80	Nom. 0,5	25	MGT3222X80
25x100	Nom. 0,5	25	MGT3225100
25x60	Nom. 0,5	25	MGT3225X60
26x60	Nom. 0,5	25	MGT3226X60
28x100	Nom. 0,5	25	MGT3228100
28x60	Nom. 0,5	25	MGT3228X60
30x70	Nom. 0,5	25	MGT3230X70
30x77	Nom. 0,5	25	MGT3230X77
30x100	Nom. 0,5	25	MGT3230100
33x94	Nom. 0,5	25	MGT3233X94
35x150	Nom. 0,5	25	MGT3235150
40x150	Nom. 0,5	25	MGT3240150
43x123	Nom. 0,5	25	MGT3243123
53x145	Nom. 0,5	25	MGT3253145

QUARTZ MICROFIBRE EXTRACTION THIMBLES

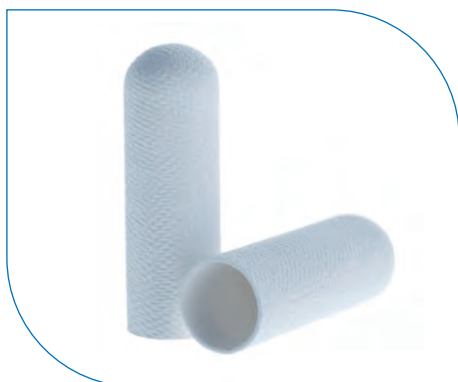

Thimbles made from extremely pure quartz microfibre, without binding agents and with a very low content of heavy metals. Resists temperatures up to 900°C. These cartridges are used for emission tests in environments with high temperatures and for the analysis of acid gases.

DIM. INNER Ø x LENGTH (mm)	PARTICLE RETENTION IN LIQUID (µm)	PACK (U.)	ART. NO.
16x50	Nom. 0,5	25	TMQ3216X50
22x80	Nom. 0,5	25	TMQ3222X80
25x60	Nom. 0,5	25	TMQ3225X60
26x60	Nom. 0,5	25	TMQ3226X60
28x100	Nom. 0,5	25	TMQ3228100
28x60	Nom. 0,5	25	TMQ3228X60
30x70	Nom. 0,5	25	TMQ3230X70
30x77	Nom. 0,5	25	TMQ3230X77
30x100	Nom. 0,5	25	TMQ3230100
33x94	Nom. 0,5	25	TMQ3233X94
35x150	Nom. 0,5	25	TMQ3235150
40x150	Nom. 0,5	25	TMQ3240150
43x123	Nom. 0,5	25	TMQ3243123
53x145	Nom. 0,5	25	TMQ3253145

FILTRATION: REAMS

ABSORBENT AND PROTECTIVE PAPER (REAMS)

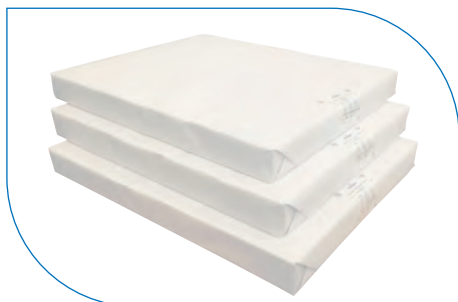

Sheets for the protection of work surfaces that help to absorb possible splashes and to mitigate the effects of liquid spills.

DIM. H x W (mm)	WEIGHT (g/m ²)	PACK (U.)	ART. NO.
420x520	60	500	RM42520060
420x520	75	500	RM42520075

ABSORBENT AND PROTECTIVE PAPER WITH PE

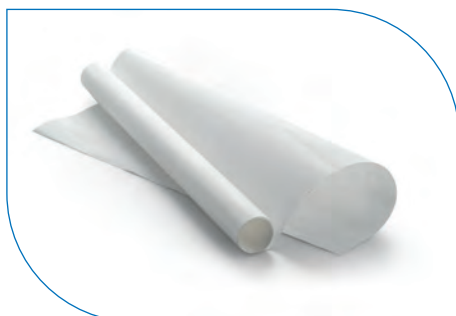

Absorbent and protective reams formed by two sheets. On the one hand, a sheet of absorbent paper for the containment of spills and splashes. On the other, a PE film that guarantees total permeability.

DIM. WxH (mm)	WEIGHT (g/m ²)	PACK (U.)	ART. NO.
420x520	125	100	RMPE125100
420x520	125	500	RMPE125500
420x520	210	100	RMPE210100
420x520	210	500	RMPE210500

FILTRATION: MEMBRANES

MEMBRANES FOR THE MOBILE PHASE FILTRATION



Scharlau's filtration line is expanded with newly added filtration membranes for mobile phase filtration. Nylon membranes and Nitrocellulose Mixed Ester membranes of the highest quality are available.

We recommend using **nylon membranes as the standard material for filtering eluents due to its chemical compatibility**. As nylon is hydrophilic in nature, these membranes are appropriate for filtering aqueous solutions and for most of the organic solvents used in HPLC. A nylon membrane has a uniform pore size, consistent flows and a very low level of extractables. It can be exposed to up to 180°C without damage and has a pH range from 3 to 12.

Mixed ester membranes are composed of a **mixture of inert cellulose nitrate and cellulose acetate polymers**. The uniform microporous structure of these filters provides the fastest flow rates and highest throughputs available in a membrane filter. Their hydrophilic nature makes them ideal for **filtering aqueous solutions, including buffers**. These filters are autoclavable at 121°C (250°F) for 20 minutes. The pH range is from 4 to 10.

NYLON

MATERIAL	Ø (mm)	PORUS SIZE (µm)	STERILE	GRID	COLOUR	PACK (U.)	ART. NO.
Nylon	47	0,22	No	No	White	100	NY47020100
Nylon	47	0,45	No	No	White	100	NY47045100
Nylon	47	0,22	No	No	White	100	NYL4720100
Nylon	47	0,45	No	No	White	100	NYL4745100

MIXED ESTER

MATERIAL	Ø (mm)	PORUS SIZE (µm)	STERILE	GRID	COLOUR	PACK (U.)	ART. NO.
EMC	47	0,22	No	No	White	100	EM47020100
EMC	47	0,45	No	No	White	100	EM47045100
EMC	47	0,22	No	No	White	100	EMC4720100
EMC	47	0,45	No	No	White	100	EMC4745100

FILTRATION MEMBRANES FOR MICROBIOLOGY

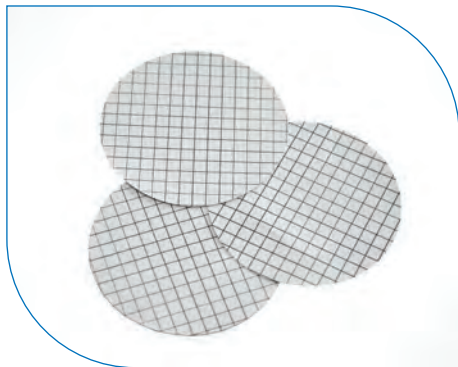

Filtration membranes especially used in the microbiological analysis of water samples. NC membranes comply with ISO 7704. PC and PES membranes are especially used in *Legionella* analysis according to ISO 11731.

MATERIAL	Ø (mm)	PORE (µm)	STERILE	COLOUR	GRID	PACK (U.)	ART. NO.
CN	47	0,2	Yes	White	Black	100	ES47020100
CN	47	0,2	Yes	Black	White	100	ES4702010N
CN	47	0,45	Yes	White	Black	100	ES47045100
PCTE	47	0,2	Yes	White	-	100	PC47020100
PES	47	0,2	No	White	-	100	PES4702000
PES	47	0,2	Yes	White	-	100	PES4702001

FILTRATION: SYRINGE FILTERS

SYRINGE FILTERS



Scharlau syringe filters are used mainly for filtering small aqueous and organic samples prior to chromatography injection. The filtered samples ensure column protection. The filter housing is made of pure PP. The result is a high-quality syringe filter fulfilling the needs of the most demanding chromatographers.

Nylon: nylon syringe filters have become the “standard” material due to their wide chemical compatibility and their hydrophobic nature. They can be used for filtering aqueous samples and most solvents.

Nylon Premium filters are subjected to a double quality control for the most demanding applications.

Regenerated cellulose: the regenerated syringe filters have a lower protein retention than those made of nylon and are less extractable than PVDF. Ideal for aqueous solutions.

PTFE: syringe filters made of PTFE and have the lowest extractables levels and the widest chemical compatibility. They are especially suitable for filtering solvents due to their hydrophobic nature. Designed for filtering the most aggressive solvents, and strongest acids and bases. Also available in hydrophilic version.

Mixed cellulose esters: Filters composed of cellulose acetate and cellulose nitrate. Because it is biologically inert, it is one of the most widely used membranes in analytical and research applications.

PVDF: polyvinylidene fluoride syringe filters are indicated for the filtration of protein samples due to their very low retention.

PP: filters of hydrophobic PP (polypropylene), great resistance to solvents, very low protein binding and good thermal compatibility. They are used for general filtration of biological samples, solvents, deionised water. Commonly used for UHPLC.

PES: The new sterile syringe filters Scharlab PES (polyethersulfone) of 25 mm diameter, 0.22 µm and 0,45 µm pore size. These filters are commonly used in molecular biology, filtration of culture media since they have a very low protein binding, high performance and low extractables level, providing maximum recovery.



NYLON PREMIUM

FILTER	Ø (mm)	PORE SIZE (µm)	STERILE	PACK (U.)	ART. NO.
Nylon	13	0,22	No	500	NY13020500
Nylon	13	0,45	No	200	NY13045200
Nylon	13	0,22	No	1000	NY13021000
Nylon	13	0,45	No	1000	NY13041000
Nylon	25	0,22	No	200	NY25020200
Nylon	25	0,22	No	1000	NY25021000
Nylon	25	0,45	No	200	NY25045200
Nylon	25	0,45	No	1000	NY25041000
Nylon with GF prefilter	25	0,45	No	200	NYP2545200
Nylon with GF prefilter	30	0,45	No	200	NYP3045200

NYLON

FILTER	Ø (mm)	PORE SIZE (µm)	STERILE	PACK (U.)	ART. NO.
Nylon	13	0,22	No	200	NYL1320200
Nylon	13	0,22	No	1000	NYL1321000
Nylon	13	0,45	No	200	NYL1345200
Nylon	13	0,45	No	1000	NYL1341000
Nylon	25	0,22	No	200	NYL2520200
Nylon	25	0,22	No	1000	NYL2521000
Nylon	25	0,45	No	200	NYL2545200
Nylon	25	0,45	No	1000	NYL2541000

REGENERATED CELLULOSE

FILTER	Ø (mm)	PORE SIZE (µm)	STERILE	PACK (U.)	ART. NO.
CR	13	0,22	No	1000	CR13021000
CR	13	0,45	No	1000	CR13041000
CR	25	0,22	No	200	CR25020200
CR	25	0,22	No	1000	CR25021000
CR	25	0,45	No	200	CR25045200
CR	25	0,45	No	1000	CR25041000

PTFE

FILTER	Ø (mm)	PORE SIZE (µm)	STERILE	PACK (U.)	ART. NO.
PTFE	13	0,22	No	200	PTF1320200
PTFE	13	0,22	No	1000	PTF1321000
PTFE	13	0,45	No	200	PTF1345200
PTFE	13	0,45	No	1000	PTF1341000
PTFE	25	0,22	No	200	PTF2520200
PTFE	25	0,22	No	1000	PTF2521000
PTFE	25	0,45	No	200	PTF2545200
PTFE	25	0,45	No	1000	PTF2541000

HYDROPHILIC PTFE

FILTER	Ø (mm)	PORE SIZE (µm)	STERILE	PACK (U.)	ART. NO.
Hydrophilic PTFE	13	0,2	No	200	PTH1320200
Hydrophilic PTFE	13	0,4	No	200	PTH1345200
Hydrophilic PTFE	25	0,2	No	200	PTH2520200
Hydrophilic PTFE	25	0,4	No	200	PTH2545200

MIXED CELLULOSE ESTERS

FILTER	Ø (mm)	PORE SIZE (µm)	STERILE	PACK (U.)	ART. NO.
MCE	13	0,22	No	200	MCE1320200
MCE	13	0,45	No	200	MCE1345200
MCE	25	0,22	No	200	MCE2520200
MCE	25	0,45	No	200	MCE2545200

PVDF

FILTER	Ø (mm)	PORE SIZE (µm)	STERILE	PACK (U.)	ART. NO.
PVDF	13	0,22	No	200	PVD1320200
PVDF	13	0,22	No	1000	PVD1321000
PVDF	13	0,45	No	200	PVD1345200
PVDF	13	0,45	No	1000	PVD1341000
PVDF	17	0,45	No	200	PV17045200
PVDF	25	0,22	No	200	PVD2520200
PVDF	25	0,22	No	1000	PVD2521000
PVDF with GF prefilter	25	0,22	No	200	PVP2520200
PVDF	25	0,45	No	200	PVD2545200
PVDF with GF prefilter	25	0,45	No	200	PVP2545200
PVDF	30	0,22	No	200	PV30020200
PVDF	30	0,45	No	200	PV30045200
PVDF	30	0,45	No	1000	PV30041000

POLYPROPYLENE

FILTER	Ø (mm)	PORE SIZE (µm)	STERILE	PACK (U.)	ART. NO.
Polypropylene	13	0,22	No	200	PPL1320200
Polypropylene	13	0,22	No	1000	PPL1321000
Polypropylene	13	0,45	No	200	PPL1345200
Polypropylene	13	0,45	No	1000	PPL1341000
Polypropylene	25	0,22	No	200	PPL2520200
Polypropylene	25	0,22	No	1000	PPL2521000
Polypropylene	25	0,45	No	200	PPL2545200
Polypropylene	25	0,45	No	1000	PPL2541000

HYDROPHILIC POLYPROPYLENE

FILTER	Ø (mm)	PORE SIZE (µm)	STERILE	PACK (U.)	ART. NO.
Hydrophilic Polypropylene	13	0,22	No	200	PPH1320200
Hydrophilic Polypropylene	13	0,45	No	200	PPH1345200
Hydrophilic Polypropylene	25	0,22	No	200	PPH2520200
Hydrophilic Polypropylene	25	0,45	No	200	PPH2545200

PES

FILTER	Ø (mm)	PORE SIZE (µm)	STERILE	PACK (U.)	ART. NO.
PES	13	0,22	No	200	PES1320200
PES	13	0,45	No	200	PES1345200
PES	25	0,22	No	200	PES2520200
PES	25	0,45	No	200	PES2545200
PES	25	0,22	Yes	50	PES252250S
PES	25	0,45	Yes	50	PES254550S

CELLULOSE ACETATE

FILTER	Ø (mm)	PORE SIZE (µm)	STERILE	PACK (U.)	ART. NO.
CA	13	0,22	No	200	CEA1320200
CA	13	0,45	No	200	CEA1345200
CA	25	0,22	No	200	CEA2520200
CA with GF prefilter	25	0,22	No	200	CEP2520200
CA	25	0,45	No	200	CEA2545200
CA with GF prefilter	25	0,45	No	200	CEP2545200

INDICATOR PAPERS

INDICATOR PAPERS

pH INDICATOR PAPER ON A ROLL



The pH indicator paper is an easy and quick method for measuring pH values in a solution. The pH is determined by a single colour change which can be matched with the colour scale at intervals of 1 pH.

DESCRIPTION	PACK (U.)	ART. NO.
pH indicator paper 1-14. Rolls of 5m x 7mm	1 roll	TP0114000R
pH indicator paper 1-11. Rolls of 5m x 7mm	1 roll	TP0111000R

pH INDICATOR STRIPS



Anti-drip strips produce an extremely clear colour change that is durable and readable until the strips dry out. Non bleeding.

DESCRIPTION	PACK (U.)	ART. NO.
pH indicator strips 4-10. Readable at intervals of 0,5 pH. 100 strips per pack	1	TP0410000S
pH indicator strips 7-14. Readable at intervals of 0,5 pH. 100 strips per pack	1	TP7514000S
pH indicator strips 0-6. Readable at intervals of 0,5 pH. 100 strips per pack	1	TP0060000S
pH indicator strips 2-9. Readable at intervals of 0,5 pH. 100 strips per pack	1	TP0209000S
pH indicator strips 0-14, 4 pads in intervals of 1 pH unit. 100 strips per pack	1	TP0014004S

SEMI-QUANTITATIVE TEST STRIPS



Scharlau's semi-quantitative test strips enable an easy and quick determination of different parameters in a solution.

DESCRIPTION	MEASUREMENT INTERVALS	PACK (U.)	ART. NO.
Nitrite indicator strips. 100 strips per package	0-0,5-1-5-10-25 ppm	1	TP002500NI
Nitrite indicator strips. 100 strips per package	0-10-25-50-100-250-500 ppm	1	TP050000NA
Peracetic acid indicator strips. 100 strips per package	0-5-10-20-30-50 ppm	1	TP005000PA
Peracetic acid indicator strips. 100 strips per package	0-100-250-500 ppm	1	TP050000PA
Peroxide indicator strips. 100 strips per package	0-1-3-10-30-100 ppm	1	TP010000PX
Peroxide indicator strips. 100 strips per package	0-100-200-400 ppm	1	TP040000PX

PIPETTES

PIPETTES: PASTEUR PIPETTES

GRADUATED PLASTIC PASTEUR PIPETTES



PE Pasteur pipettes. Ideal for transferring and dispensing any type of liquid. Two capacities, 5 and 7 ml graduated to 1 and 3 ml respectively.

CAPACITY (ml)	GRADUATION (ml)	LENGTH (mm)	STERILE	PACK (U.)	ART. NO.
5	1	150	No	500	PPP0110000
7	3	150	No	500	PPP0120000

PIPETTES: TIPS FOR AUTOMATIC PIPETTE FILLER

UNIVERSAL TIPS FOR AUTOMATIC PIPETTES

0,2-10 μ l



New range of Scharlau Polypropylene tips. Compatible with most brands of automatic pipettes (Sartorius, Brand, Eppendorf, Finnpiquette, Gilson, Socorex, etc.). Available in bags, autoclavable racks, radiation sterilised racks and individually packed sterile tips.

VOL. (μ l)	TYPE	COLOUR	PRESENTATION	PACK (U.)	ART. NO.
0,2-10	Universal	Natural	Bag	1000	000P0210-1
0,2-10	Universal	Natural	Rack	10x96	000P0210-2

0,5-20 µl



VOL. (µl)	TYPE	COLOUR	PRESENTATION	PACK (U.)	ART. NO.
0,5-20	Universal	Natural	Rack	10x96	000P0520-2

5-200 µl



VOL. (µl)	TYPE	COLOUR	PRESENTATION	PACK (U.)	ART. NO.
5-200	Universal	Yellow	Bag	1000	000P5202-1
5-200	Universal	Yellow	Rack	10x96	000P5200-2

5-200 µl



VOL. (µl)	TYPE	COLOUR	PRESENTATION	PACK (U.)	ART. NO.
5-200	Eppendorf	Yellow	Bag	1000	00PC5200-1
5-200	Eppendorf	Yellow	Rack	10x96	00PC5200-2

5-300 µl



VOL. (µl)	TYPE	COLOUR	PRESENTATION	PACK (U.)	ART. NO.
5-300	Universal	Natural	Bag	1000	000P5300-1
5-300	Universal	Natural	Rack	10x96	000P5300-2

100-1000 µl



VOL. (µl)	TYPE	COLOUR	PRESENTATION	PACK (U.)	ART. NO.
100-1000	Universal	Blue	Bag	1000	000P1000-1
100-1000	Universal	Blue	Rack	10x96	000P1000-2

100-1000 µl



VOL. (µl)	TYPE	COLOUR	PRESENTATION	PACK (U.)	ART. NO.
100-1000	Eppendorf	Blue	Bag	1000	00PC1000-1
100-1000	Eppendorf	Blue	Rack	8x60	00PC1000-2

1000-5000 µl



VOL. (µl)	TYPE	COLOUR	PRESENTATION	PACK (U.)	ART. NO.
1000-5000	Universal	Natural	Bag	250	000P5000-1
1000-5000	Universal	Natural	Rack	4x50	000P5000-2

TIPS IN RECHARGEABLE RACKS

Rechargeable system racks. They consist of empty racks and racks with charging points for recharging themselves. This saves time in the laboratory by not having to put the ends of the bag onto the rack. Racks are available both adapted to the system as the same charges. In the first purchase, both empty racks and racks with charging points must be purchased. Tips available in two volumes.

EMPTY RACKS

DESCRIPTION (µl)	PACK (U.)	ART. NO.
Empty racks for 200 µl tip refills	10	RC000P5200
Empty racks for 1000 µl tip refills	10	RC000P1000

CHARGING TIPS RACKS

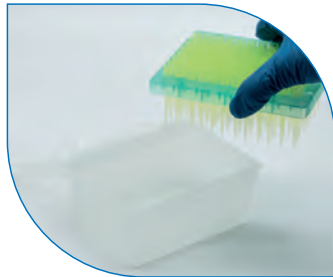

RR000P5200

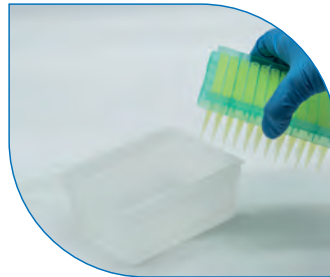

RR00PC5200



RR000P1000

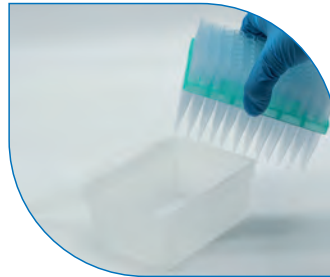

RR00PC1000

DESCRIPTION	VOLUME (µl)	PACK (U.)	ART. NO.
Recharging tips	200	5x96	RR000P5200
Recharging tips with capillary	200	5x96	RR00PC5200
Recharging tips	1000	5x96	RR000P1000
Recharging tips with capillary	1000	5x96	RR00PC1000

SCHARLAB READER APP QR

The wise choice

FILTER TIPS

The table below shows the Scharlab filter tips compatibilities with main pipette brands*.

MODEL	TRADEMARK	10 µl	10 µl XL	20 µl	100 µl	200 µl	1000 µl
Transferpette®	Brand	•	•			•	•
CAPP Bravo	CAPP	•	•	•	•	•	•
CAPP Aero		•	•	•	•	•	•
Research® Plus	Eppendorf	•	•	•	•	•	•
Finnpipette Digital	Finnpipette	•	•		•	•	•
Pipetman Classic™	Gilson	•	•	•	•	•	•
Rainin Classic	Rainin	•	•		•	•	•
Proline® Plus	Sartorius	•	•		•	•	•
mLine		•	•		•	•	•
Automatic pipettes	VWR	•	•		•	•	•
	Labnet	•	•		•	•	•
	HTL	•	•		•	•	•

*The compatibilities are just a suggestion by the supplier.

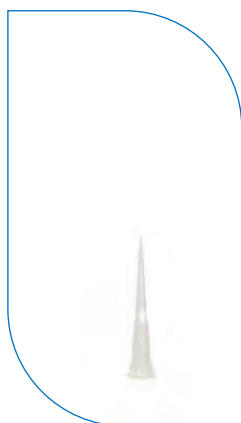

00PF0110-2

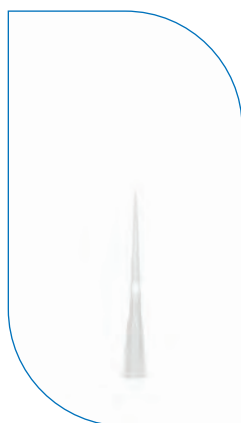

000PF120-2



00PF1100-2



00PF1200-2



PF10010002

VOL. (µl)	PRESENTATION	COLOUR	PACK (U.)	ART. NO.
0,1-10	Bag	Natural	1000	00PF0110-1
0,1-10	Rack	Natural	10x96	00PF0110-2
0,1-10 XL type	Bag	Natural	1000	PFXL0110-1
0,1-10 XL type	Rack	Natural	10x96	PFXL0110-2
1-20	Bag	Natural	1000	000PF120-1
1-20	Rack	Natural	10x96	000PF120-2
1-100	Bag	Natural	1000	00PF1100-1
1-100	Rack	Natural	10x96	00PF1100-2
1-200	Bag	Natural	1000	00PF1200-1
1-200	Rack	Natural	10x96	00PF1200-2
100-1000	Bag	Natural	1000	PF10010001
100-1000	Rack	Natural	8x96	PF001000-2

PLATES

PLATES: PETRI DISHES AND ACCESSORIES

PETRI DISHES

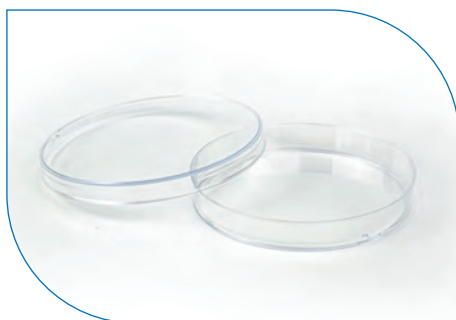

Scharlab Petri dishes are manufactured in high transparency PS following a fully automated process with strict quality controls, giving them the strength and transparency ideal for microbiological applications. Their great mechanical resistance makes them non-deformable. The dishes with winds facilitate the circulation of the air and avoid possible condensation. Aseptically produced in "Cleanroom ISO 6" rooms, a level of sterility is guaranteed. In addition, dishes are sterilised by radiation. They have a ring to facilitate and improve stability once stacked.

DESCRIPTION	Ø (mm)	HEIGHT (mm)	AMOUNT/BAG	PACK (U.)	ART. NO.
Aseptic ISO 6, 3 vents	90	14,2	20	480	PPD-90143A
Sterile, 3 vents	90	14,2	20	480	PPD-90143E

STERILE DISPOSABLE INOCULATING LOOPS



Inoculation loops sterilised by radiation, manufactured in PS of 1 and 10 µl. Bags in peel-packs of 20 units with lot number and expiry date printed. Delivered with certified calibration and sterilisation.

VOLUME (µl)	COLOUR	PRESENTATION	PACK (U.)	ART. NO.
1	Green	Bags 20 u.	1000	PIL0030120
10	Blue	Bags 20 u.	1000	PIL0041020

STERILE BAGS FOR HOMOGENISATION

Scharlau sterile bags for homogenisation processes and analysis of solid samples. Notably resistant to the stress processes they are subjected to in the homogenisers. Compatible with any homogeniser. Three models available. Bags without filter, bags with lateral filter for the separation of fibrous samples and bags with total filter for pasty samples. The filters allow filtration of the sample during the homogenisation process and separate the bag into two spaces: one to introduce the sample and another to facilitate sampling with the pipette.

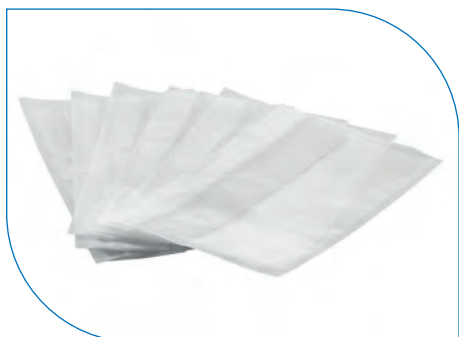

DESCRIPTION	CAP. (ml)	USABLE VOLUME (ml)	PORUS SIZE	DIM. W x H (mm)	PACK (U.)	ART. NO.
Without filter	400	50-300	-	175-300	500 (20x25)	BAG0400-01
With lateral filter	400	50-300	<250	190-300	500 (20x25)	BAG0400-02
With total filter	400	50-300	280	190-300	500 (20x25)	BAG0400-03



NEW CATALOGUE

Chemicals and Reagents

Chemicals,
Organic Standards,
Chromatography,
Glassware
and Consumables



SAFETY

SAFETY: ABSORBENTS FOR LABORATORY

CHEMISPILL® , ABSORBENTS AGAINST UNEXPECTED SPILLAGES



The new Chemispill® range, products with a high neutralisation capacity and high absorption power, allows the collection of laboratory spillages with total safety and reliability. This family of products consists of 3 complementary materials for the absorption and/or neutralisation of unforeseen spills:

Chemispill® Sorb: General absorbent of very low density with high absorption power. Capable of effectively absorbing organic, aqueous, oily spills, etc., without leaving residual marks or generating dusty residues.

Chemispill® H+: Absorbent material with a high neutralisation capacity. Efficiently neutralises any acid spill. Contains pH indicator, without phenolphthalein.

Chemispill® OH-: Absorbent product with a high neutralisation capacity. Efficiently neutralises any alkaline discharge. Contains pH indicator, without phenolphthalein.

Spills Kit Chemispill®: Complete safety Kit for laboratory discharges. It is delivered in a comfortable and smart briefcase, easy to use and transport. Contains: 1 bottle of each Chemispill® absorbent, Scharlau nitrile gloves, laboratory glasses, waste collection bags, scraper, brush and dustpan, and instructions for use.

Chemispill® safety shelf: Wall shelf to hang the entire Chemispill® range of products on the laboratory wall.



DESCRIPTION	PACK	ART. NO.
Chemispill® H+, absorbent and neutraliser for spilled acids, with indicator	2 Kg	AB00012000
Chemispill® H+, absorbent and neutraliser for spilled acids, with indicator	5 Kg	AB0001005P
Chemispill® Sorb, absorbent for spilled liquids	400 g	AB00020400
Chemispill® Sorb, absorbent for spilled liquids	1 Kg	AB00021000
Chemispill® Sorb, absorbent for spilled liquids	4 Kg	AB00024000
Chemispill® OH-, absorbent and neutraliser for spilled alkalis, with indicator	2 Kg	AB00032000
Chemispill® OH-, absorbent and neutraliser for spilled alkalis, with indicator	5 Kg	AB0003005P
Spills Kit Chemispill®	1 u.	AB0004-KIT
Chemispill® safety shelf	1 u.	AB0005ESTA

SAFETY: GLOVES

DISPOSABLE, POWDER-FREE, BLUE NITRILE GLOVES FOR EXAMINATION



Category III PPE gloves (European Directive 89/686/EEC, for Personal Protection Equipment), for the protection of user's hands against chemical, microbiological and virus risks. Class I examination gloves (European Directive 93/42/EEC, which governs Sanitary Products). Comply with EN 420:2003 + A1:2009 + ERRATUM: 2011 (general glove requirements), ISO 374-1:2016 (protection against dangerous chemicals), ISO 374-5: 2016 (protection against micro-organisms) and EN 455 1-2-3 (medical disposable gloves).

Ambidextrous.

Rolled/beaded cuff prevents glove rolldown/rollback and provides drip protection for the forearm.

Superior tactile sensitivity and dexterity.

External micro-textured fingertips provide a secure grip under dry and wet conditions.

Smooth, chlorinated inner surface for easy donning/removal.

Latex-free, eliminate the risk of latex allergy.

Free of certain additives: reduces the risk of allergies caused by accelerators and coagulants used in some manufacturing processes.

Powder-free, minimizing the risk of irritation.

AQL 1.5.

Suitable for contact with foodstuffs.

Thickness: 0,09 mm (palm), 0,12 mm (fingertips).



ISO 374-1:2016 / Type B

ISO 374-5:2016



JKT



VIRUS



SIZE	LENGTH (mm)	THICKNESS FINGERTIPS/PALM (mm)	PACK (U.)	ART. NO.
S	240	0,12/0,09	100	GLV-NSP00S
M	240	0,12/0,09	100	GLV-NSP00M
L	240	0,12/0,09	100	GLV-NSP00L
XL	240	0,12/0,09	100	GLV-NSP00XL
S	240	0,12/0,09	10x100	GLVBNSP00S
M	240	0,12/0,09	10x100	GLVBNSP00M
L	240	0,12/0,09	10x100	GLVBNSP00L
XL	240	0,12/0,09	10x100	GLVBNSP00XL

TECHNICAL DATA SHEET IN OUR WEBSITE

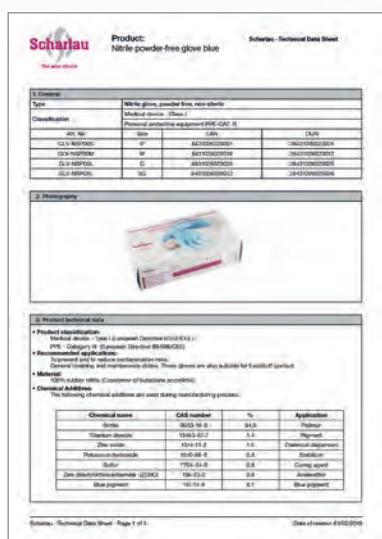

Download here the TDS



TIMERS

TIMERS

DIGITAL TIMER (ALARM CLOCK)

Three independent functions. Voice notification, can be activated or deactivated. Automatic repetition. 8 alarm sounds. Memory. 24-hour chronometer and countdown.



DESCRIPTION	PACK (U.)	ART. NO.
Digital timer (alarm clock)	1	502EL8845S

TUBES

TUBES: TUBES FOR CENTRIFUGE

CONICAL TUBES 15 ml POLYPROPYLENE



PP centrifuge tubes conical bottom. Leakproof closure. Easy-to-read graduation. CE marking. Cap also made of PP. commonly used in centrifugation, sample storage and molecular biology among other applications.

DESCRIPTION	EXT. Ø x H (mm)	CENTRIF. RESIST (g)	STERILE	PACK (U.)	ART. NO.
15 ml tube	21x120	-	No	1700	PCT0151700
15 ml tube	21x120	-	Yes	500	PCT0151001

CONICAL TUBES 50 ml POLYPROPYLENE



PP centrifuge tubes with conical bottom without flap. Leakproof closure. Easy-to-read graduations. Commonly used in centrifugation, sample storage and molecular biology among other applications. The tubes have space for writing.

DESCRIPTION	EXT. Ø x H (mm)	CENTRIF. RESIST (g)	STERILE	PACK (U.)	ART. NO.
50 ml tube	28x118	12000	No	500	PCT0501000
50 ml tube	28x118	12000	Yes	1x500	PCT0501002
50 ml tube self-standing	28x118	12000	No	500	PCT0502000
50 ml tube self-standing	28x118	12000	Yes	1x500	PCT0502002

CROSS REFERENCES: BBL – SCHARLAU (ALPHABETICAL)

ART. NO. BBL	DESCRIPTION BBL	ART. NO. SCHARLAU	DESCRIPTION SCHARLAU	PAGE
212304	Agar Grade A	07-004	Agar Bacteriological	146
210912	AK Agar # 2	01-069	Sporulating Agar	107
210986	Antibiotic Medium 13	02-165	Sabouraud Broth (Eur. Pharm.)	101
212303	Beef Extract Powder	07-515	Beef Extract	146
211027	Biggy Agar	01-137	Nickerson Agar	88
299068	Bile Esculin Agar	01-265	Bile Esculin Modified Agar	44
211037	Blood Agar Base (Infusion Agar)	01-352	Blood Agar Base	44
211065	Brain Heart Infusion Agar	01-599	Brain Heart Infusion Agar (BHI Agar)	46
211059	Brain Heart Infusion Broth	02-599	Brain Heart Infusion Broth (BHI Broth)	46
212367	Buffered Peptone Water	02-568	Buffered Peptone Phosphate Water	48
211102	Cary & Blair Transport Medium	03-643	Cary-Blair Transport Medium	51
212309	CIN Agar (Yersinia Selective Agar)	01-444	Yersinia CIN Agar Base	126
212218	CLED Agar	01-047	CLED Agar	54
211124	Columbia Agar Base	01-034	Blood Agar Base (Columbia)	45
212104	Columbia CNA Agar	01-703	Columbia CNA Agar Base	56
212330	Dermatophyte Test Medium Base	01-442	Dermatophytes Selective Agar	58
211179	DNase Test Agar	01-346	DNase Agar	59
297005	EE Broth Mossel Enrichment	02-064	Enrichment Enterobacteriaceae Broth (EE Broth)	61
211199	Endo Agar	01-589	Endo Agar Base	60
212205	Enterococcosel	01-592	Bile Esculin Azide Agar	44
211221	Eosine Methylene Blue Agar, Levine	01-068	Eosin Methylene Blue Agar (EMB Agar)	61
211260	Fluid Thioglycollate Medium	03-187	Thioglycollate Fluid Medium	110
211287	m-Green Yeast & Mold Broth	02-633	m-Green Broth	66
212211	Hektoen Enteric Agar	01-216	Hektoen Enteric Agar	67
211317	Kligler Iron Agar	01-103	Kligler Iron Agar (KIA)	70
211333	Lactose Broth	02-105	Lactose Broth	70
211338	Lauryl Sulfate Broth	02-108	Tryptose Lauryl Sulfate Broth	117
211363	Lysine Iron Agar	01-094	Lysine Iron Agar (LIA)	78
211387	MacConkey Agar	01-118	MacConkey Agar (Eur. Pharm.)	78
211407	Mannitol Salt Agar	01-116	Chapman Agar (Mannitol Salt Agar)	53
296309	Motility Nitrate (MN) Medium	03-454	Stuart Ringertz Transport Medium	108
211443	Mueller Hinton Broth	02-136	Mueller-Hinton Broth	87
211438	Mueller Hinton II Agar	01-136	Mueller-Hinton Agar	86
211486	Orange Serum Agar	01-698	Orange Serum Agar	90
211506	Phenol-Red Broth Base	02-032	Phenol Red Broth Base	93
211537	Phenylalanine Agar	01-083	Phenylalanine Agar (PPA)	93
211906	Phytone Peptone	07-155	Soy Peptone	146
211558	Purple Broth Base	02-663	Purple Broth Base	97
211584	Sabouraud Dextrose Agar	01-165	Sabouraud Dextrose Agar	103
211597	Salmonella Shigella Agar	01-555	Salmonella Shigella Agar (SS Agar)	104
211578	SIM Medium	03-176	SIM Medium	106
211620	Simmons Citrate Agar	01-177	Simmons Citrate Agar	106
211638	Standard Methods Agar (Tryptone Glucose Yeast Agar)	01-161	Plate Count Agar (PCA)	94
211651	Sterility Test Broth	02-186	Thioglycollate Broth	110
296004	Tech Agar	01-001	King A Agar (P Agar)	69
211917	Tellurite Solution 1%	06-089	Potassium Tellurite Sterile Solution 1%	65, 122, 145
211736	Todd Hewith Broth	02-191	Todd-Hewitt Broth	111
211921	Trypticase Peptone	07-119	Tryptone - Casein Trypsic Peptone	146
211043	Trypticase Soy Agar (Soy Bean Casein Digest Agar)	01-200	Tryptic Soy Agar (TSA) (Eur. Pharm.)	112
211764	Trypticase Soy Agar w. Polysorbate 80 and Lecithin	01-613	Microbial Content Test Agar	83
211768	Trypticase Soy Broth	02-200	Tryptic Soy Broth (TSB) (Eur. Pharm.)	114
296264	Trypticase Soy Broth, Sterile	02-575	Tryptic Soy Broth (TSB) (Eur. Pharm.)	114
211749	TSI Agar	01-192	Triple Sugar Iron Agar (TSI Agar)	111
211690	TSN Agar	01-195	Tryptone Sulfite Neomycin Agar (TSN Agar)	116
211795	Urea Agar Base	01-261	Urea Agar Base	120
211838	XLD Agar	01-211	Xylose Lysine Deoxycholate Agar (XLD Agar) (Eur. Pharm.)	124
211929	Yeast Extract	07-079	Yeast Extract	146

CROSS REFERENCES: BBL – SCHARLAU (NUMERICAL)

ART. NO. BBL	DESCRIPTION BBL	ART. NO. SCHARLAU	DESCRIPTION SCHARLAU	PAGE
210912	AK Agar # 2	01-069	Sporulating Agar	107
210986	Antibiotic Medium 13	02-165	Sabouraud Broth (Eur. Pharm.)	101
211027	Biggy Agar	01-137	Nickerson Agar	88
211037	Blood Agar Base (Infusion Agar)	01-352	Blood Agar Base	44
211043	Trypticase Soy Agar (Soy Bean Casein Digest Agar)	01-200	Tryptic Soy Agar (TSA) (Eur. Pharm.)	112
211059	Brain Heart Infusion Broth	02-599	Brain Heart Infusion Broth (BHI Broth)	46
211065	Brain Heart Infusion Agar	01-599	Brain Heart Infusion Agar (BHI Agar)	46
211102	Cary & Blair Transport Medium	03-643	Cary-Blair Transport Medium	51
211124	Columbia Agar Base	01-034	Blood Agar Base (Columbia)	45
211179	DNase Test Agar	01-346	DNase Agar	59
211199	Endo Agar	01-589	Endo Agar Base	60
211221	Eosine Methylene Blue Agar, Levine	01-068	Eosin Methylene Blue Agar (EMB Agar)	61
211260	Fluid Thioglycollate Medium	03-187	Thioglycollate Fluid Medium	110
211287	m-Green Yeast & Mold Broth	02-633	m-Green Broth	66
211317	Kligler Iron Agar	01-103	Kligler Iron Agar (KIA)	70
211333	Lactose Broth	02-105	Lactose Broth	70
211338	Lauryl Sulfate Broth	02-108	Tryptose Lauryl Sulfate Broth	117
211363	Lysine Iron Agar	01-094	Lysine Iron Agar (LIA)	78
211387	MacConkey Agar	01-118	MacConkey Agar (Eur. Pharm.)	78
211407	Mannitol Salt Agar	01-116	Chapman Agar (Mannitol Salt Agar)	53
211438	Mueller Hinton II Agar	01-136	Mueller-Hinton Agar	86
211443	Mueller Hinton Broth	02-136	Mueller-Hinton Broth	87
211486	Orange Serum Agar	01-698	Orange Serum Agar	90
211506	Phenol-Red Broth Base	02-032	Phenol Red Broth Base	93
211537	Phenylalanine Agar	01-083	Phenylalanine Agar (PPA)	93
211558	Purple Broth Base	02-663	Purple Broth Base	97
211578	SIM Medium	03-176	SIM Medium	106
211584	Sabouraud Dextrose Agar	01-165	Sabouraud Dextrose Agar	103
211597	Salmonella Shigella Agar	01-555	Salmonella Shigella Agar (SS Agar)	104
211620	Simmons Citrate Agar	01-177	Simmons Citrate Agar	106
211638	Standard Methods Agar (Tryptone Glucose Yeast Agar)	01-161	Plate Count Agar (PCA)	94
211651	Sterility Test Broth	02-186	Thioglycollate Broth	110
211690	TSN Agar	01-195	Tryptone Sulfite Neomycin Agar (TSN Agar)	116
211736	Todd Hewith Broth	02-191	Todd-Hewitt Broth	111
211749	TSI Agar	01-192	Triple Sugar Iron Agar (TSI Agar)	111
211764	Trypticase Soy Agar w. Polysorbate 80 and Lecithin	01-613	Microbial Content Test Agar	83
211768	Trypticase Soy Broth	02-200	Tryptic Soy Broth (TSB) (Eur. Pharm.)	114
211795	Urea Agar Base	01-261	Urea Agar Base	120
211838	XLD Agar	01-211	Xylose Lysine Deoxycholate Agar (XLD Agar) (Eur. Pharm.)	124
211906	Phytone Peptone	07-155	Soy Peptone	146
211917	Tellurite Solution 1%	06-089	Potassium Tellurite Sterile Solution 1%	65, 122, 145
211921	Trypticase Peptone	07-119	Tryptone - Casein Tryptic Peptone	146
211929	Yeast Extract	07-079	Yeast Extract	146
212104	Columbia CNA Agar	01-703	Columbia CNA Agar Base	56
212205	Enterococcosel	01-592	Bile Esculin Azide Agar	44
212211	Hektoen Enteric Agar	01-216	Hektoen Enteric Agar	67
212218	CLED Agar	01-047	CLED Agar	54
212303	Beef Extract Powder	07-515	Beef Extract	146
212304	Agar Grade A	07-004	Agar Bacteriological	146
212309	CIN Agar (Yersinia Selective Agar)	01-444	Yersinia CIN Agar Base	126
212330	Dermatophyte Test Medium Base	01-442	Dermatophytes Selective Agar	58
212367	Buffered Peptone Water	02-568	Buffered Peptone Phosphate Water	48
296004	Tech Agar	01-001	King A Agar (P Agar)	69
296264	Trypticase Soy Broth, Sterile	02-575	Tryptic Soy Broth (TSB) (Eur. Pharm.)	114
296309	Motility Nitrate (Mn) Medium	03-454	Stuart Ringertz Transport Medium	108
297005	EE Broth Mossel Enrichment	02-064	Enrichment Enterobacteriaceae Broth (EE Broth)	61
299068	Bile Esculin Agar	01-265	Bile Esculin Modified Agar	44

CROSS REFERENCES: DIFCO - SCHARLAU (ALPHABETICAL)

ART. NO. DIFCO	DESCRIPTION DIFCO	ART. NO. SCHARLAU	DESCRIPTION SCHARLAU	PAGE
226340	Antibiotic Medium 1	01-009	Antibiotic Medium A pH 6,6 (Eur. Pharm.)	37
246310	Antibiotic Medium 10	01-016	Antibiotic Medium B (Eur. Pharm.)	37
259310	Antibiotic Medium 11	01-017	Antibiotic Medium A pH 7,9 (Eur. Pharm.)	37
243100	Antibiotic Medium 19	01-434	Antibiotic Medium F (Eur. Pharm.)	38
265430	APT Agar	01-026	APT Agar	39
214010	Bacto Agar	07-004	Agar Bacteriological	146
211520	Bacto Beef Extract, Desiccated	07-515	Beef Extract	146
225930	Bacto Casitone	07-154	Tryptone - Casein Pancreatic Peptone	146
243620	Bacto Soytone	07-155	Soy Peptone	146
249240	Bacto Todd Hewitt Broth	02-191	Todd-Hewitt Broth	111
211705	Bacto Tryptone	07-119	Tryptone - Casein Trypsic Peptone	146
211713	Bacto Tryptose	07-197	Tryptose	146
212750	Bacto Yeast Extract	07-079	Yeast Extract	146
276840	Baird Parker Agar Base	01-030	Baird Parker Agar Base	41
269620	Blood Agar Base N. 2	01-505	Blood Agar Base No. 2	45
241830	Brain Heart Infusion Agar	01-599	Brain Heart Infusion Agar (BHI Agar)	46
256120	Brain Heart Infusion Porcine	02-599	Brain Heart Infusion Broth (BHI Broth)	46
228530	Brilliant Green Agar	01-203	Brilliant Green Agar (BGA)	47
218801	Brilliant Green Agar Modified	01-309	Brilliant Green Modified Agar	47
274000	Brilliant Green Bile Broth 2%	02-041	Brilliant Green Bile 2% Broth	47
218105	Buffered Peptone Water	02-568	Buffered Peptone Phosphate Water	48
285420	Cetrimide Agar Base	01-160	Cetrimide Agar (Eur. Pharm.)	52
279240	Columbia Blood Agar Base	01-034	Blood Agar Base (Columbia)	45
242010	Desoxycholate Lactose Agar	01-057	Deoxycholate Lactose Agar	58
263220	DNase Test Agar	01-346	DNase Agar	59
258710	DRBC Agar Base	01-657	Dichloran Rose Bengal Chloramphenicol Agar	59
231430	EC Medium	02-060	E. coli Broth (EC Broth)	60
256620	EE Broth Mossel	02-064	Enrichment Enterobacteriaceae Broth (EE Broth)	61
233472	Egg-Yolk Enrichment 50%	06-016	Sterile Egg Yolk Emulsion	40, 41, 119, 144
274620	m-Enterococcus Agar	01-579	Slanetz Bartley Agar	107
212107	EVA Broth	02-028	Azide Ethyl Violet Broth (EVA Broth)	40
267720	m-FC Agar	01-287	Fecal Coliforms Agar (m-FC Agar)	62
264210	Fluid Sabouraud Medium	02-165	Sabouraud Broth (Eur. Pharm.)	101
225650	Fluid Thioglycollate Medium	03-187	Thioglycollate Fluid Medium	110
211767	Fraser Broth Base	02-496	Listeria Enrichment Broth Fraser	76
228950	GC Medium Base	01-310	GC Agar Base	64
218091	Giolitti Cantoni Broth Base	02-230	Giolitti-Cantoni Broth	65
248610	GN Broth, Hajna	02-093	Gram Negative Broth (GN Broth)	66
285340	Hektoen Enteric Agar	01-216	Hektoen Enteric Agar	67
249610	KF Streptococcus Agar	01-294	Kenner Fecal Agar (KF Agar)	69
288210	Lactobacilli MRS Agar	01-135	MRS Agar	85
288130	Lactobacilli MRS Broth	02-135	MRS Broth	85
211835	Lactose Broth	02-105	Lactose Broth	70
224150	Lauryl Tryptose Broth	02-108	Tryptose Lauryl Sulfate Broth	117
244520	LB Agar, Miller	01-385	LB Agar (Miller)	72
240230	LB Broth, Lennox	02-406	LB Broth (Lennox)	72
244620	LB Broth, Miller	02-385	LB Broth (Miller)	73
268010	Letheen Agar	01-236	Letheen Agar	73
263110	Letheen Agar Modified	01-237	Letheen Modified Agar	74
268110	Letheen Broth	02-236	Letheen Broth	74
263010	Letheen Broth Modified	02-237	Letheen Modified Broth	74
222220	Listeria Enrichment Broth	02-498	Listeria Enrichment Broth Base (Lovett)	75
241420	Luria Broth Base, Miller	02-384	LB Broth	72
284920	Lysine Iron Agar	01-094	Lysine Iron Agar (LIA)	78
212123	MacConkey Agar	01-118	MacConkey Agar (Eur. Pharm.)	78
220100	MacConkey Broth	02-611	MacConkey Broth (Eur. Pharm.)	79
230650	Mannitol Salt Agar	01-116	Chapman Agar (Mannitol Salt Agar)	53
212185	Marine Agar 2216	01-291	Marine Agar	81
218971	Maximum Recovery Diluent	02-510	Maximum Recovery Diluent (MRD)	82
255320	Microbial Content Test Agar	01-613	Microbial Content Test Agar	83
218501	Mineral Modified Glutamate Broth	02-656	Mineral Modified Glutamate Medium Base	83
273520	MIO Medium	03-422	Motility Indol Ornithine Fluid Medium (MIO)	84
216300	MR-VP Medium	02-207	Methyl Red Voges Proskauer Broth (MRVP Broth)	82
225250	Mueller Hinton Agar	01-136	Mueller-Hinton Agar	86

ART. NO. DIFCO	DESCRIPTION DIFCO	ART. NO. SCHARLAU	DESCRIPTION SCHARLAU	PAGE
275730	Mueller Hinton Broth (Not cation-adjusted)	02-136	Mueller-Hinton Broth	87
218531	Muller Kauffman Tetrathionate Broth Base	02-335	Müller-Kauffmann Tetrathionate Broth Base	87
281010	MYP Agar	01-262	Bacillus cereus Agar	40
225710	NIH Thioglycollate Broth	02-186	Thioglycollate Broth	110
226810	Nitrate Broth	02-138	Nitrate Broth	88
213000	Nutrient Agar (APHA)	01-144	Nutrient Agar (APHA, ISO)	89
234000	Nutrient Broth	02-144	Nutrient Broth (APHA)	89
218111	O.G.Y.E Agar Base	01-275	Sabouraud Oxytetracycline Agar (OGYEA)	104
268820	O/F Basal Medium	03-037	Oxidation-Fermentation Fluid Medium Base (O/F Medium)	91
222530	Oxford Medium Base	01-471	Oxford Agar Base	90
263620	Palcam Medium Base	01-470	Palcam Agar Base	91
274520	Phenylalanine Agar	01-083	Phenylalanine Agar (PPA)	93
247940	Plate Count Agar (Tryptone Glucose Yeast Agar)	01-161	Plate Count Agar (PCA)	94
213400	Potato Dextrose Agar	01-483	Potato Dextrose Agar (Eur. Pharm.)	95
254920	Potato Dextrose Broth	02-483	Potato Dextrose Broth	95
211693	Proteose Peptone N. 3	07-625	Proteose Peptone No. 3	146
244820	Pseudomonas Agar F	01-029	King B Agar (F Agar)	69
244910	Pseudomonas Agar P	01-001	King A Agar (P Agar)	69
218263	R2A Agar	01-540	R2A Agar	97
218681	Rappaport Vassiliadis Msrv Medium Semi-Solid Modification	03-376	Rappaport Vassiliadis Modified SemiSolid Medium Base	98
218581	Rappaport Vassiliadis R10 Broth	02-379	Rappaport Vassiliadis Broth	98
218081	Reinforced Cloristidial Medium	01-289	Reinforced Clostridial Agar	99
218312	Rose Bengal Agar Base	01-301	Rose Bengal Chloramphenicol Agar	100
210950	Sabouraud Dextrose Agar	01-165	Sabouraud Dextrose Agar	103
274500	Salmonella Shigella Agar	01-555	Salmonella Shigella Agar (SS Agar)	104
227540	Selenite Broth	02-598	Selenite Broth Base	105
268740	Selenite Cystine Broth	02-602	Selenite Cystine Broth Base	106
281110	SFP Agar Base	01-278	Tryptose Sulfite Cycloserine Agar (TSC Agar)	119
232100	Skim Milk	06-019	Skimmed Milk Powder	145, 146
284530	SPS Agar	01-050	Clostridium perfringens Selective Agar (SPS Agar)	55
265020	TCBS Agar	01-567	TCBS Agar	108
226540	Triple Sugar Iron Agar	01-192	Triple Sugar Iron Agar (TSI Agar)	111
236950	Tryptic Soy Agar (Soy Bean Casein Agar)	01-200	Tryptic Soy Agar (TSA) (Eur. Pharm.)	112
223000	Tryptone Glucose Extract Agar	01-082	Tryptone Glucose Extract Agar (TGE Agar)	115
264410	Tryptone Water	03-156	Tryptone Water	116
211825	Trytic Soy Broth	02-200	Tryptic Soy Broth (TSB) (Eur. Pharm.)	114
286220	Trytic Soy Broth W/O Dextrose	02-227	Tryptic Soy Broth without Dextrose	115
231121	TTC Solution 1%	06-023	TTC Sterile Solution 1%	53, 69, 107, 145
227210	Urea Broth	02-202	Urea Broth Base	120
222330	UVM Modified Listeria Enrichment Broth	02-472	Listeria Enrichment Broth Base (UVM)	76
211695	Violet Red Bile Agar	01-164	Violet Red Bile Agar (VRB Agar)	121
218661	Violet Red Bile Glucose Agar	01-295	Violet Red Bile Dextrose Agar (VRBD Agar) (Eur. Pharm.)	121
256220	VJ Agar (Vogel Johnson Agar)	01-206	Vogel Johnson Agar (VJ Agar)	122
242420	WL Nutrient Medium	01-210	WL Nutrient Agar	122
278850	XLD Agar	01-211	Xylose Lysine Deoxycholate Agar (XLD Agar) (Eur. Pharm.)	124
223420	XLT4 Agar Base	01-708	XLT4 Agar Base	123
219001	Yeast Extract Glucose Chloramphenicol Agar	01-366	Chloramphenicol Glucose Agar (CGA)	53
218172	Yersinia Selective Agar	01-444	Yersinia CIN Agar Base	126
271210	YM Agar	01-219	Yeast Malt Agar (YM Agar)	125
271120	YM Broth	02-219	Yeast Malt Broth	125

CROSS REFERENCES: DIFCO - SCHARLAU (NUMERICAL)

ART. NO. DIFCO	DESCRIPTION DIFCO	ART. NO. SCHARLAU	DESCRIPTION SCHARLAU	PAGE
210950	Sabouraud Dextrose Agar	01-165	Sabouraud Dextrose Agar	103
211520	Bacto Beef Extract, Desiccated	07-515	Beef Extract	146
211693	Proteose Peptone N. 3	07-625	Proteose Peptone No. 3	146
211695	Violet Red Bile Agar	01-164	Violet Red Bile Agar (VRB Agar)	121
211705	Bacto Tryptone	07-119	Tryptone - Casein Trypsic Peptone	146
211713	Bacto Tryptose	07-197	Tryptose	146
211767	Fraser Broth Base	02-496	Listeria Enrichment Broth Fraser	76
211825	Tryptic Soy Broth	02-200	Tryptic Soy Broth (TSB) (Eur. Pharm.)	114
211835	Lactose Broth	02-105	Lactose Broth	70
212107	EVA Broth	02-028	Azide Ethyl Violet Broth (EVA Broth)	40
212123	MacConkey Agar	01-118	MacConkey Agar (Eur. Pharm.)	78
212185	Marine Agar 2216	01-291	Marine Agar	81
212750	Bacto Yeast Extract	07-079	Yeast Extract	146
213000	Nutrient Agar (APHA)	01-144	Nutrient Agar (APHA, ISO)	89
213400	Potato Dextrose Agar	01-483	Potato Dextrose Agar (Eur. Pharm.)	95
214010	Bacto Agar	07-004	Agar Bacteriological	146
216300	MR-VP Medium	02-207	Methyl Red Voges Proskauer Broth (MRVP Broth)	82
218081	Reinforced Cloristidial Medium	01-289	Reinforced Clostridial Agar	99
218091	Giolitti Cantoni Broth Base	02-230	Giolitti-Cantoni Broth	65
218105	Buffered Peptone Water	02-568	Buffered Peptone Phosphate Water	48
218111	O.G.Y.E Agar Base	01-275	Sabouraud Oxytetracycline Agar (OGYEA)	104
218172	Yersinia Selective Agar	01-444	Yersinia CIN Agar Base	126
218263	R2A Agar	01-540	R2A Agar	97
218312	Rose Bengal Agar Base	01-301	Rose Bengal Chloramphenicol Agar	100
218501	Mineral Modified Glutamate Broth	02-656	Mineral Modified Glutamate Medium Base	83
218531	Muller Kauffman Tetrathionate Broth Base	02-335	Müller-Kauffmann Tetrathionate Broth Base	87
218581	Rappaport Vassiliadis R10 Broth	02-379	Rappaport Vassiliadis Broth	98
218661	Violet Red Bile Glucose Agar	01-295	Violet Red Bile Dextrose Agar (VRBD Agar) (Eur. Pharm.)	121
218681	Rappaport Vassiliadis MsrV Medium Semi-Solid Modification	03-376	Rappaport Vassiliadis Modified SemiSolid Medium Base	98
218801	Brilliant Green Agar Modified	01-309	Brilliant Green Modified Agar	47
218971	Maximum Recovery Diluent	02-510	Maximum Recovery Diluent (MRD)	82
219001	Yeast Extract Glucose Chloramphenicol Agar	01-366	Chloramphenicol Glucose Agar (CGA)	53
220100	MacConkey Broth	02-611	MacConkey Broth (Eur. Pharm.)	79
222220	Listeria Enrichment Broth	02-498	Listeria Enrichment Broth Base (Lovett)	75
222330	UVM Modified Listeria Enrichment Broth	02-472	Listeria Enrichment Broth Base (UVM)	76
222530	Oxford Medium Base	01-471	Oxford Agar Base	90
223000	Tryptone Glucose Extract Agar	01-082	Tryptone Glucose Extract Agar (TGE Agar)	115
223420	XLT4 Agar Base	01-708	XLT4 Agar Base	123
224150	Lauryl Tryptose Broth	02-108	Tryptose Lauryl Sulfate Broth	117
225250	Mueller Hinton Agar	01-136	Mueller-Hinton Agar	86
225650	Fluid Thioglycollate Medium	03-187	Thioglycollate Fluid Medium	110
225710	NIH Thioglycollate Broth	02-186	Thioglycollate Broth	110
225930	Bacto Casitone	07-154	Tryptone - Casein Pancreatic Peptone	146
226340	Antibiotic Medium 1	01-009	Antibiotic Medium A pH 6,6 (Eur. Pharm.)	37
226540	Triple Sugar Iron Agar	01-192	Triple Sugar Iron Agar (TSI Agar)	111
226810	Nitrate Broth	02-138	Nitrate Broth	88
227210	Urea Broth	02-202	Urea Broth Base	120
227540	Selenite Broth	02-598	Selenite Broth Base	105
228530	Brilliant Green Agar	01-203	Brilliant Green Agar (BGA)	47
228950	GC Medium Base	01-310	GC Agar Base	64
230650	Mannitol Salt Agar	01-116	Chapman Agar (Mannitol Salt Agar)	53
231121	TTC Solution 1%	06-023	TTC Sterile Solution 1%	53, 69, 107, 145
231430	EC Medium	02-060	E. coli Broth (EC Broth)	60
232100	Skim Milk	06-019	Skimmed Milk Powder	145, 146
233472	Egg-Yolk Enrichment 50%	06-016	Sterile Egg Yolk Emulsion	40, 41, 119, 144
234000	Nutrient Broth	02-144	Nutrient Broth (APHA)	89
236950	Tryptic Soy Agar (Soy Bean Casein Agar)	01-200	Tryptic Soy Agar (TSA) (Eur. Pharm.)	112
240230	LB Broth, Lennox	02-406	LB Broth (Lennox)	72
241420	Luria Broth Base, Miller	02-384	LB Broth	72
241830	Brain Heart Infusion Agar	01-599	Brain Heart Infusion Agar (BHI Agar)	46
242010	Desoxycholate Lactose Agar	01-057	Desoxycholate Lactose Agar	58
242420	WL Nutrient Medium	01-210	WL Nutrient Agar	122
243100	Antibiotic Medium 19	01-434	Antibiotic Medium F (Eur. Pharm.)	38
243620	Bacto Soytone	07-155	Soy Peptone	146

ART. NO. DIFCO	DESCRIPTION DIFCO	ART. NO. SCHARLAU	DESCRIPTION SCHARLAU	PAGE
244520	LB Agar, Miller	01-385	LB Agar (Miller)	72
244620	LB Broth, Miller	02-385	LB Broth (Miller)	73
244820	Pseudomonas Agar F	01-029	King B Agar (F Agar)	69
244910	Pseudomonas Agar P	01-001	King A Agar (P Agar)	69
246310	Antibiotic Medium 10	01-016	Antibiotic Medium B (Eur. Pharm.)	37
247940	Plate Count Agar (Tryptone Glucose Yeast Agar)	01-161	Plate Count Agar (PCA)	94
248610	GN Broth, Hajna	02-093	Gram Negative Broth (GN Broth)	66
249240	Bacto Todd Hewitt Broth	02-191	Todd-Hewitt Broth	111
249610	KF Streptococcus Agar	01-294	Kenner Fecal Agar (KF Agar)	69
254920	Potato Dextrose Broth	02-483	Potato Dextrose Broth	95
255320	Microbial Content Test Agar	01-613	Microbial Content Test Agar	83
256120	Brain Heart Infusion Porcine	02-599	Brain Heart Infusion Broth (BHI Broth)	46
256220	VJ Agar (Vogel Johnson Agar)	01-206	Vogel Johnson Agar (VJ Agar)	122
256620	EE Broth Mossel	02-064	Enrichment Enterobacteriaceae Broth (EE Broth)	61
258710	DRBC Agar Base	01-657	Dichloran Rose Bengal Chloramphenicol Agar	59
259310	Antibiotic Medium 11	01-017	Antibiotic Medium A pH 7,9 (Eur. Pharm.)	37
263010	Lethen Broth Modified	02-237	Lethen Modified Broth	74
263110	Lethen Agar Modified	01-237	Lethen Modified Agar	74
263220	DNase Test Agar	01-346	DNase Agar	59
263620	Palcam Medium Base	01-470	Palcam Agar Base	91
264210	Fluid Sabouraud Medium	02-165	Sabouraud Broth (Eur. Pharm.)	101
264410	Tryptone Water	03-156	Tryptone Water	116
265020	TCBS Agar	01-567	TCBS Agar	108
265430	APT Agar	01-026	APT Agar	39
267720	m-FC Agar	01-287	Fecal Coliforms Agar (m-FC Agar)	62
268010	Lethen Agar	01-236	Lethen Agar	73
268110	Lethen Broth	02-236	Lethen Broth	74
268740	Selenite Cystine Broth	02-602	Selenite Cystine Broth Base	106
268820	O/F Basal Medium	03-037	Oxidation-Fermentation Fluid Medium Base (O/F Medium)	91
269620	Blood Agar Base N. 2	01-505	Blood Agar Base No. 2	45
271120	YM Broth	02-219	Yeast Malt Broth	125
271210	YM Agar	01-219	Yeast Malt Agar (YM Agar)	125
273520	MIO Medium	03-422	Motility Indol Ornithine Fluid Medium (MIO)	84
274000	Brilliant Green Bile Broth 2%	02-041	Brilliant Green Bile 2% Broth	47
274500	Salmonella Shigella Agar	01-555	Salmonella Shigella Agar (SS Agar)	104
274520	Phenylalanine Agar	01-083	Phenylalanine Agar (PPA)	93
274620	m-Enterococcus Agar	01-579	Stanetz Bartley Agar	107
275730	Mueller Hinton Broth (Not cation-adjusted)	02-136	Mueller-Hinton Broth	87
276840	Baird Parker Agar Base	01-030	Baird Parker Agar Base	41
278850	XLD Agar	01-211	Xylose Lysine Deoxycholate Agar (XLD Agar) (Eur. Pharm.)	124
279240	Columbia Blood Agar Base	01-034	Blood Agar Base (Columbia)	45
281010	MYP Agar	01-262	Bacillus cereus Agar	40
281110	SFP Agar Base	01-278	Tryptose Sulfite Cycloserine Agar (TSC Agar)	119
284530	SPS Agar	01-050	Clostridium perfringens Selective Agar (SPS Agar)	55
284920	Lysine Iron Agar	01-094	Lysine Iron Agar (LIA)	78
285340	Hektoen Enteric Agar	01-216	Hektoen Enteric Agar	67
285420	Cetrimide Agar Base	01-160	Cetrimide Agar (Eur. Pharm.)	52
286220	Tryptic Soy Broth w/o Dextrose	02-227	Tryptic Soy Broth without Dextrose	115
288130	Lactobacilli MRS Broth	02-135	MRS Broth	85
288210	Lactobacilli MRS Agar	01-135	MRS Agar	85

CROSS REFERENCES: MERCK - SCHARLAU (ALPHABETICAL)

ART. NO. MERCK	DESCRIPTION MERCK	ART. NO. SCHARLAU	DESCRIPTION SCHARLAU	PAGE
1.05272.0500	Antibiotic Agar N. 1	01-009	Antibiotic Medium A pH 6,6 (Eur. Pharm.)	37
1.05269.0500	Antibiotic Agar N. 11	01-017	Antibiotic Medium A pH 7,9 (Eur. Pharm.)	37
1.05273.0500	Antibiotic Broth (Medium No. 3)	02-011	Antibiotic Medium C (Eur. Pharm.)	38
1.10453.0500	APT Agar	01-026	APT Agar	39
1.01590.0500	Azide Dextrose Broth	02-027	Azide Dextrose Broth (Rothe)	40
1.05406.0500	Baird Parker Agar	01-030	Baird Parker Agar Base	41
1.07994.0500	BAT medium	01-675	BAT Agar	42
1.00072.0500	Bile Aesculin Azide Agar	01-265	Bile Esculin Modified Agar	44
1.04054	Bile salt mixture for microbiology	07-525	Bile Salts No.3	146
1.10886.0500	Blood Agar Base	01-352	Blood Agar Base	44
1.10328.0500	Blood Agar Base N. 2	01-505	Blood Agar Base No. 2	45
1.00068.0500	Bolton Selective Enrichment Broth	02-688	Bolton Enrichment Broth Base	45
1.07232.0500	BPLS Agar (USP) (Brilliant green Phenol red Lactose Sucrose)	01-203	Brilliant Green Agar (BGA)	47
1.10747.0500	BPLS Agar, mod	01-309	Brilliant Green Modified Agar	47
1.13825.0500	Brain Heart Agar	01-599	Brain Heart Infusion Agar (BHI Agar)	46
1.10493.0500	Brain Heart Broth	02-599	Brain Heart Infusion Broth (BHI Broth)	46
1.05454.0500	Brilliant-green-2%-Bile Broth	02-041	Brilliant Green Bile 2% Broth	47
1.01638.0500	BROLACIN Agar (CLED Agar)	01-047	CLED Agar	54
1.07228.0500	Buffered Peptone Water	02-277	Buffered Peptone Water (ISO)	49
1.00070.0500	Campylobacter Blood-Free Selective Agar (modified CCDA)	01-685	CCD Modified Agar (Charcoal Cefoperazone Deoxycholate)	52
1.10456.0500	Candida Selective Agar acc. to Nickerson	01-137	Nickerson Agar	88
1.02245.0500	Caseinhydrolysate (Acid Hydrolyzed)	07-151	Casein Acid Hydrolysate	146
1.10426.0500	Chromocult Coliform Agar	01-695	Coliform Agar Base Chromogenic Microinstant®	128
335032ZF	Chromocult Listeria Enrichment Supplement	06-754	Microinstant® Listeria Enrichment Supplement	130
1.16122.0500	Chromocult TBX (Tryptone Bile X-glucuronide) Agar	01-619	Tryptone Bile Glucuronic Agar (TBX Agar) Microinstant®	130
1.10455.0500	Columbia Agar Base	01-034	Blood Agar Base (Columbia)	45
1.02894.0500	Deoxycholate Lactose Agar	01-057	Deoxycholate Lactose Agar	58
1.08960.0500	Dermatophyte selective Agar (DTM) acc. to Taplin	01-442	Dermatophytes Selective Agar	58
1.10860.0500	Dextrose Tryptone Agar	01-556	Dextrose Tryptone Purple Bromcresol Agar	58
1.00465.0500	Dichloran Glycerol (DG18) Agar	01-485	DG 18 Agar	59
1.00466.0500	Dichloran Rose Bengal Chloramphenicol (DRBC) Agar	01-657	Dichloran Rose Bengal Chloramphenicol Agar	59
1.10449.0500	DNase Test Agar	01-346	DNase Agar	59
1.10765.0500	EC Broth	02-060	E. coli Broth (EC Broth)	60
1.03784.0001	Egg-Yolk Emulsion Sterile	06-016	Sterile Egg Yolk Emulsion	40, 41, 119, 144
1.03785.0001	Egg-Yolk Tellurite Emulsion 20% Sterile	06-026	Egg's Yolk Tellurite Sterile Emulsion	41, 144
1.04044.0500	Endo Agar	01-589	Endo Agar Base	60
1.05403.0500	Enterobacteriaceae Enrichment Broth acc. Mossel	02-064	Enrichment Enterobacteriaceae Broth (EE Broth)	61
1.05289.0500	mf-Enterococcus Selective Agar Base acc. to Slanetz Bartley	01-579	Slanetz Bartley Agar	107
1.10398.0500	Fraser Listeria Selective Enrichment Broth Base	02-496	Listeria Enrichment Broth Fraser	76
1.10675.0500	Giolitti Cantoni Broth	02-230	Giolitti-Cantoni Broth	65
1.10756.0500	GN Enrichment Broth acc. to Hajna	02-093	Gram Negative Broth (GN Broth)	66
109218	Gram staining set	VI0027	Crystal Violet Dye Solution	156
1.11681.0500	Hektoen Enteric Agar	01-216	Hektoen Enteric Agar	67
1.05222.0500	Kanamycin Esculine Azide Agar	01-263	Kanamycin Esculin Azide Agar (KAA Agar)	68
1.10707.0500	KF Streptococcus Agar Base	01-294	Kenner Fecal Agar (KF Agar)	69
1.03913.0500	Kligler Agar	01-103	Kligler Iron Agar (KIA)	70
1.12523.1000	Lactalbumin Hydrolysate	07-455	Lactalbumin Hydrolysate	146
1.0768.0500	Lactosa TTC Agar with Tergitol R 7	01-053	Chapman TTC Agar	53
1.07661.0500	Lactose Broth	02-105	Lactose Broth	70
1.10266.0500	Lauryl Sulfate Broth	02-108	Tryptose Lauryl Sulfate Broth	117
1.10283.0500	LB-Agar (Miller)	01-385	LB Agar (Miller)	72
1.10285.0500	LB-Broth (Miller)	02-385	LB Broth (Miller)	73
1.10242.0001	Legionella CYE Agar	01-687	BCYE Legionella Agar Base	42, 43, 73
1.10404.0500	Letheen Agar Base Modified	01-237	Letheen Modified Agar	74
1.10405.0500	Letheen Broth Modified	02-237	Letheen Modified Broth	74
1.01342.0500	Levine EMB Agar	01-068	Eosin Methylene Blue Agar (EMB Agar)	61
1.10549.0500	Listeria Enrichment Broth (LEB) acc. to FDA/IDF-FIL	02-498	Listeria Enrichment Broth Base (Lovett)	75
1.11640.0500	Lysine Iron Agar	01-094	Lysine Iron Agar (LIA)	78
1.05465.0500	MacConkey Agar	01-118	MacConkey Agar (Eur. Pharm.)	78
1.05396.0500	MacConkey Broth	02-611	MacConkey Broth (Eur. Pharm.)	79
1.05391.0500	Malt extract	07-080	Malt Extract	146
1.05398.0500	Malt Extract Agar	01-573	Malt Extract Agar No. 2	80
1.05397.0500	Malt Extract Broth	02-491	Malt Extract Broth No. 2	81
1.05404.0500	Mannitol Salt Phenol Red Agar	01-116	Chapman Agar (Mannitol Salt Agar)	53
1.12535.0500	Maximum recovery Diluent	02-510	Maximum Recovery Diluent (MRD)	82
1.03979.0500	Meat extract	07-075	Meat Extract	146
1.05712.0500	MR VP Broth	02-207	Methyl Red Voges Proskauer Broth (MRVP Broth)	82
1.10660.0500	MRS Agar	01-135	MRS Agar	85

ART. NO. MERCK	DESCRIPTION MERCK	ART. NO. SCHARLAU	DESCRIPTION SCHARLAU	PAGE
1.10661.0500	MRS Broth	02-135	MRS Broth	85
1.09878.0500	MSRV Medium, Base Modified	03-376	Rappaport Vassiliadis Modified SemiSolid Medium Base	98
1.10293.0500	Mueller Hinton Broth	02-136	Mueller-Hinton Broth	87
1.05435.0500	Mueller-Hinton Agar acc. to NCCLS	01-136	Mueller-Hinton Agar	86
1.05878.0500	Müller Kauffmann tetrathionate-Novobiocin Broth (MKTn)	02-335	Müller-Kauffmann Tetrathionate Broth Base	87
1.05267.0500	MYP Agar	01-262	Bacillus cereus Agar	40
1.05450.0500	Nutrient Agar (APHA)	01-144	Nutrient Agar (APHA, ISO)	89
1.05443.0500	Nutrient Broth	02-144	Nutrient Broth (APHA)	89
1.10282.0500	O/F Basal Medium acc. to Hugh & Leifson	03-037	Oxidation-Fermentation Fluid Medium Base (O/F Medium)	91
1.10673.0500	Orange Serum Agar	01-698	Orange Serum Agar	90
1.03756.0500	OX Bile Dried	07-039	Bile	146
1.07004.0500	Oxford Listeria Selective Agar Base	01-471	Oxford Agar Base	90
1.05978.0500	Oxytetracyclin Glucose Yeast Extract Agar (O.G.Y.E Agar)	01-275	Sabouraud Oxytetracycline Agar (OGYEA)	104
1.11755.0500	Palcam Listeria Selective Agar Base acc. to Van Netten	01-470	Palcam Agar Base	91
1.07213.0500	Peptone from Casein, pancreatic	07-154	Tryptone - Casein Pancreatic Peptone	146
1.02239.0500	Peptone from Casein (Tryptone)	07-119	Tryptone - Casein Trypsin Peptone	146
1.07284.1000	Peptone from Gelatin (Pancreatic)	07-153	Gelatin Pancreatic Peptone	146
1.07224.1000	Peptone from Meat (peptic), granulated	07-152	Meat Peptone	146
1.07212.0500	Peptone from Soyameal (papainic), granulated	07-155	Soy Peptone	146
1.10987.0500	Phenol-Red Broth Base	02-032	Phenol Red Broth Base	93
1.05463.0500	Plate Count Agar (Casein Peptone Dextrose Yeast Agar)	01-161	Plate Count Agar (PCA)	94
1.15338.0500	Plate Count Skim Milk Agar	01-412	Plate Count Skim Milk Agar	95
1.10130.0500	Potato Dextrose Agar	01-483	Potato Dextrose Agar (Eur. Pharm.)	95
1.10989.0500	Pseudomonas Agar F Base	01-029	King B Agar (F Agar)	69
1.10988.0500	Pseudomonas Agar P Base	01-001	King A Agar (P Agar)	69
1.07620.0500	Pseudomonas Selective Agar Base	01-609	CN Selective Agar	55
1.05284.0500	Pseudomonas Selective Agar Base (Cetrimide Agar)	01-160	Cetrimide Agar (Eur. Pharm.)	52
1.00416.0500	R2A Agar	01-540	R2A Agar	97
1.07700.0500	Rappaport Vassiliadis Broth	02-379	Rappaport Vassiliadis Broth	98
1.05410.0500	Reinforced Clostridial Agar	01-289	Reinforced Clostridial Agar	99
1.05411.0500	Reinforced Clostridial Medium (RCM)	03-289	Reinforced Clostridial Medium (Eur. Pharm.)	99
1.00467.0500	Rose Bengal Chloramphenicol (RBC) Agar	01-301	Rose Bengal Chloramphenicol Agar	100
1.08339.0500	Sabouraud 2% Dextrose Broth	02-165	Sabouraud Broth (Eur. Pharm.)	101
1.05438.0500	Sabouraud 4% Dextrose Agar	01-165	Sabouraud Dextrose Agar	103
1.07667.0500	Salmonella-Shigella Agar	01-555	Salmonella Shigella Agar (SS Agar)	104
1.07709.0500	Selenite Cystine Broth	02-602	Selenite Cystine Broth Base	106
1.07717.0500	Selenite Enrichment Broth Leifson	02-598	Selenite Broth Base	105
1.05470.0500	SIM Medium	03-176	SIM Medium	106
1.02501.0500	Simmons Citrate Agar	01-177	Simmons Citrate Agar	106
1.15363.0500	Skim Milk Powder	06-019	Skimmed Milk Powder	145, 146
1.10582.0500	Sodium Chloride Peptone Broth Buffered	02-494	Buffered Peptone Water 0,1% (Eur. Pharm.)	50
1.10235.0500	SPS Agar	01-050	Clostridium perfringens Selective Agar (SPS Agar)	55
1.01621.0500	Standard Count Agar	01-635	Nutrient Agar (ISO)	89
1.05178.0500	TBG-Broth modified	02-629	Tetrathionate Bile Brilliant Green Broth Base	109
1.10263.0500	TCBS Agar (Vibrio Selective Agar)	01-567	TCBS Agar	108
1.10128.0500	TGE Agar	01-082	Tryptone Glucose Extract Agar (TGE Agar)	115
1.08190.0500	Thioglycollate Broth	02-186	Thioglycollate Broth	110
1.03915.0500	Triple Sugar Iron Agar (TSI Agar)	01-192	Triple Sugar Iron Agar (TSI Agar)	111
1.07324.0500	Tryptic Soy Agar (CASO) w. Polysorbate 80 and Lecithin	01-613	Microbial Content Test Agar	83
1.05458.0500	Tryptic Soy Agar (TSA) (CASO Agar)	01-200	Tryptic Soy Agar (TSA) (Eur. Pharm.)	112
1.05459.0500	Tryptic Soy Broth (CASO Broth)	02-200	Tryptic Soy Broth (TSB) (Eur. Pharm.)	114
1.10859.0500	Tryptone Water	03-156	Tryptone Water	116
1.11972.0500	TSC Agar	01-278	Tryptose Sulfite Cycloserine Agar (TSC Agar)	119
1.05264.0500	TSN Agar (Perfringens Selective Agar acc. to Marshall)	01-195	Tryptone Sulfite Neomycin Agar (TSN Agar)	116
1.08492.0500	Urea Agar Base acc. Christensen	01-261	Urea Agar Base	120
1.08483.0500	Urea Broth	02-202	Urea Broth Base	120
1.05405.0500	Vogel-Johnson Agar Base	01-206	Vogel Johnson Agar (VJ Agar)	122
1.01406.0500	VRB Agar (Violet Red Bile Agar)	01-164	Violet Red Bile Agar (VRB Agar)	121
1.10275.0500	VRBD (Violet Red Bile Dextrose) agar acc. to Mossel	01-295	Violet Red Bile Dextrose Agar (VRBD Agar) (Eur. Pharm.)	121
1.10866.0500	WL Nutrient Agar	01-210	WL Nutrient Agar	122
1.05448.0500	Wort Agar	01-132	Wort Agar	123
1.05449.0500	Wort Broth Base	02-132	Wort Broth	123
1.05287.0500	XLD (Xylose Lysine Deoxycholate) Agar	01-552	Xylose Lysine Deoxycholate Modified Agar	124
1.05290.0500	XLD Agar	01-211	Xylose Lysine Deoxycholate Agar (XLD Agar) (Eur. Pharm.)	124
1.13919.0500	XLT4 Agar	01-708	XLT4 Agar Base	123
1.03753.0500	Yeast Extract, granulated	07-079	Yeast Extract	146
1.16000.0500	YGC Agar (Yeast Extract Glucose Chloramphenicol Agar)	01-366	Chloramphenicol Glucose Agar (CGA)	53

CROSS REFERENCES: MERCK - SCHARLAU (NUMERICAL)

ART. NO. MERCK	DESCRIPTION MERCK	ART. NO. SCHARLAU	DESCRIPTION SCHARLAU	PAGE
1.04054	Bile Salt Mixture for Microbiology	07-525	Bile Salts No.3	146
109218	Gram Staining Set	VI0027	Crystal Violet Dye Solution	156
1.0768.0500	Lactosa TTC Agar with Tergitol R 7	01-053	Chapman TTC Agar	53
1.00068.0500	Bolton Selective Enrichment Broth	02-688	Bolton Enrichment Broth Base	45
1.00070.0500	Campylobacter Blood-Free Selective Agar (modified CCDA)	01-685	CCD Modified Agar (Charcoal Cefoperazone Deoxycholate)	52
1.00072.0500	Bile Aesculin Azide Agar	01-265	Bile Esculin Modified Agar	44
1.00416.0500	R2A Agar	01-540	R2A Agar	97
1.00465.0500	Dichloran Glycerol (DG18) Agar	01-485	DG 18 Agar	59
1.00466.0500	Dichloran Rose Bengal Chloramphenicol (DRBC) Agar	01-657	Dichloran Rose Bengal Chloramphenicol Agar	59
1.00467.0500	Rose Bengal Chloramphenicol (RBC) Agar	01-301	Rose Bengal Chloramphenicol Agar	100
1.01342.0500	Levine EMB Agar	01-068	Eosin Methylene Blue Agar (EMB Agar)	61
1.01406.0500	VRB Agar (Violet Red Bile Agar)	01-164	Violet Red Bile Agar (VRB Agar)	121
1.01590.0500	Azide Dextrose Broth	02-027	Azide Dextrose Broth (Rothe)	40
1.01621.0500	Standard Count Agar	01-635	Nutrient Agar (ISO)	89
1.01638.0500	Brolacin Agar (CLED Agar)	01-047	CLED Agar	54
1.02239.0500	Peptone from Caseine (Tryptone)	07-119	Tryptone - Casein Tryptic Peptone	146
1.02245.0500	Caseinhydrolysate (Acid Hydrolyzed)	07-151	Casein Acid Hydrolysate	146
1.02501.0500	Simmons Citrate Agar	01-177	Simmons Citrate Agar	106
1.02894.0500	Deoxycholate Lactose Agar	01-057	Deoxycholate Lactose Agar	58
1.03753.0500	Yeast Extract, granulated	07-079	Yeast Extract	146
1.03756.0500	OX Bile Dried	07-039	Bile	146
1.03784.0001	Egg-Yolk Emulsion Sterile	06-016	Sterile Egg Yolk Emulsion	40, 41, 119, 144
1.03785.0001	Egg-Yolk Tellurite Emulsion 20% Sterile	06-026	Egg's Yolk Tellurite Sterile Emulsion	41, 144
1.03913.0500	Kligler Agar	01-103	Kligler Iron Agar (KIA)	70
1.03915.0500	Triple Sugar Iron Agar (TSI Agar)	01-192	Triple Sugar Iron Agar (TSI Agar)	111
1.03979.0500	Meat Extract	07-075	Meat Extract	146
1.04044.0500	Endo Agar	01-589	Endo Agar Base	60
1.05178.0500	TBG-Broth Modified	02-629	Tetrathionate Bile Brilliant Green Broth Base	109
1.05222.0500	Kanamycin Esculine Azide Agar	01-263	Kanamycin Esculin Azide Agar (KAA Agar)	68
1.05264.0500	TSN Agar (Perfringens Selective Agar acc. to Marshall)	01-195	Tryptone Sulfite Neomycin Agar (TSN Agar)	116
1.05267.0500	MYP Agar	01-262	Bacillus cereus Agar	40
1.05269.0500	Antibiotic Agar N. 11	01-017	Antibiotic Medium A pH 7,9 (Eur. Pharm.)	37
1.05272.0500	Antibiotic Agar N. 1	01-009	Antibiotic Medium A pH 6,6 (Eur. Pharm.)	37
1.05273.0500	Antibiotic Broth (Medium No. 3)	02-011	Antibiotic Medium C (Eur. Pharm.)	38
1.05284.0500	Pseudomonas Selective Agar Base (Cetrimide Agar)	01-160	Cetrimide Agar (Eur. Pharm.)	52
1.05287.0500	XLD (Xylose Lysine Deoxycholate) Agar	01-552	Xylose Lysine Deoxycholate Modified Agar	124
1.05289.0500	mf-Enterococcus Selective Agar Base acc. to Slanetz Bartley	01-579	Slanetz Bartley Agar	107
1.05290.0500	XLD Agar	01-211	Xylose Lysine Deoxycholate Agar (XLD Agar) (Eur. Pharm.)	124
1.05391.0500	Malt extract	07-080	Malt Extract	146
1.05396.0500	MacConkey Broth	02-611	MacConkey Broth (Eur. Pharm.)	79
1.05397.0500	Malt Extract Broth	02-491	Malt Extract Broth No. 2	81
1.05398.0500	Malt Extract Agar	01-573	Malt Extract Agar No. 2	80
1.05403.0500	Enterobacteriaceae Enrichment Broth acc. Mossel	02-064	Enrichment Enterobacteriaceae Broth (EE Broth)	61
1.05404.0500	Mannitol Salt Phenol Red Agar	01-116	Chapman Agar (Mannitol Salt Agar)	53
1.05405.0500	Vogel-Johnson Agar Base	01-206	Vogel Johnson Agar (VJ Agar)	122
1.05406.0500	Baird Parker Agar	01-030	Baird Parker Agar Base	41
1.05410.0500	Reinforced Clostridial Agar	01-289	Reinforced Clostridial Agar	99
1.05411.0500	Reinforced Clostridial Medium (RCM)	03-289	Reinforced Clostridial Medium (Eur. Pharm.)	99
1.05435.0500	Mueller-Hinton Agar acc. to NCCLS	01-136	Mueller-Hinton Agar	86
1.05438.0500	Sabouraud 4% Dextrose Agar	01-165	Sabouraud Dextrose Agar	103
1.05443.0500	Nutrient Broth	02-144	Nutrient Broth (APHA)	89
1.05448.0500	Wort Agar	01-132	Wort Agar	123
1.05449.0500	Wort Broth Base	02-132	Wort Broth	123
1.05450.0500	Nutrient Agar (APHA)	01-144	Nutrient Agar (APHA, ISO)	89
1.05454.0500	Brilliant-Green-2%-Bile Broth	02-041	Brilliant Green Bile 2% Broth	47
1.05458.0500	Tryptic Soy Agar (TSA) (CASO Agar)	01-200	Tryptic Soy Agar (TSA) (Eur. Pharm.)	112
1.05459.0500	Tryptic Soy Broth (CASO Broth)	02-200	Tryptic Soy Broth (TSB) (Eur. Pharm.)	114
1.05463.0500	Plate Count Agar (Casein Peptone Dextrose Yeast Agar)	01-161	Plate Count Agar (PCA)	94
1.05465.0500	MacConkey Agar	01-118	MacConkey Agar (Eur. Pharm.)	78
1.05470.0500	SIM Medium	03-176	SIM Medium	106
1.05712.0500	MR VP Broth	02-207	Methyl Red Voges Proskauer Broth (MRVP Broth)	82
1.05878.0500	Müller Kauffmann Tetrathionate-Novobiocin Broth (MKTn)	02-335	Müller-Kauffmann Tetrathionate Broth Base	87
1.05978.0500	Oxytetracyclin Glucose Yeast Extract Agar (O.G.Y.E Agar)	01-275	Sabouraud Oxytetracycline Agar (OGYEA)	104
1.07004.0500	Oxford Listeria Selective Agar Base	01-471	Oxford Agar Base	90
1.07212.0500	Peptone from Soyameal (papainic), granulated	07-155	Soy Peptone	146
1.07213.0500	Peptone from casein, pancreatic	07-154	Tryptone - Casein Pancreatic Peptone	146
1.07224.1000	Peptone from meat (peptic), granulated	07-152	Meat Peptone	146
1.07228.0500	Buffered Peptone Water	02-277	Buffered Peptone Water (ISO)	49

ART. NO. MERCK	DESCRIPTION MERCK	ART. NO. SCHARLAU	DESCRIPTION SCHARLAU	PAGE
1.07232.0500	BPLS Agar (USP) (Brilliant green Phenol red Lactose Sucrose	01-203	Brilliant Green Agar (BGA)	47
1.07284.1000	Peptone from Gelatin (pancreatic)	07-153	Gelatin Pancreatic Peptone	146
1.07324.0500	Tryptic Soy Agar (CASO) w. Polysorbate 80 and Lecithin	01-613	Microbial Content Test Agar	83
1.07620.0500	Pseudomonas Selective Agar Base	01-609	CN Selective Agar	55
1.07661.0500	Lactose Broth	02-105	Lactose Broth	70
1.07667.0500	Salmonella-Shigella Agar	01-555	Salmonella Shigella Agar (SS Agar)	104
1.07700.0500	Rappaport Vassiliadis Broth	02-379	Rappaport Vassiliadis Broth	98
1.07709.0500	Selenite Cystine Broth	02-602	Selenite Cystine Broth Base	106
1.07717.0500	Selenite Enrichment Broth Leifson	02-598	Selenite Broth Base	105
1.07994.0500	BAT medium	01-675	BAT Agar	42
1.08190.0500	Thioglycollate Broth	02-186	Thioglycollate Broth	110
1.08339.0500	Sabouraud 2% Dextrose Broth	02-165	Sabouraud Broth (Eur. Pharm.)	101
1.08483.0500	Urea Broth	02-202	Urea Broth Base	120
1.08492.0500	Urea Agar Base acc CHRISTENSEN	01-261	Urea Agar Base	120
1.08960.0500	Dermatophyte selective Agar (DTM) acc. to Taplin	01-442	Dermatophytes Selective Agar	58
1.09878.0500	MSRV Medium, Base Modified	03-376	Rappaport Vassiliadis Modified SemiSolid Medium Base	98
1.10128.0500	TGE Agar	01-082	Tryptone Glucose Extract Agar (TGE Agar)	115
1.10130.0500	Potato Dextrose Agar	01-483	Potato Dextrose Agar (Eur. Pharm.)	95
1.10235.0500	SPS Agar	01-050	Clostridium perfringens Selective Agar (SPS Agar)	55
1.10242.0001	Legionella CYE Agar	01-687	BCYE Legionella Agar Base	42, 43, 73
1.10263.0500	TCBS Agar (Vibrio Selective Agar)	01-567	TCBS Agar	108
1.10266.0500	Lauryl Sulfate Broth	02-108	Tryptose Lauryl Sulfate Broth	117
1.10275.0500	VRBD (Violet Red Bile Dextrose) agar acc. to Mossel	01-295	Violet Red Bile Dextrose Agar (VRBD Agar) (Eur. Pharm.)	121
1.10282.0500	O/F Basal Medium acc. to Hugh & Leifson	03-037	Oxidation-Fermentation Fluid Medium Base (O/F Medium)	91
1.10283.0500	LB-Agar (Miller)	01-385	LB Agar (Miller)	72
1.10285.0500	LB-Broth (Miller)	02-385	LB Broth (Miller)	73
1.10293.0500	Mueller Hinton Broth	02-136	Mueller-Hinton Broth	87
1.10328.0500	Blood Agar Base N. 2	01-505	Blood Agar Base No. 2	45
1.10398.0500	Fraser Listeria Selective Enrichment broth Base	02-496	Listeria Enrichment Broth Fraser	76
1.10404.0500	Letheen Agar Base Modified	01-237	Letheen Modified Agar	74
1.10405.0500	Letheen Broth Modified	02-237	Letheen Modified Broth	74
1.10426.0500	Chromocult Coliform Agar	01-695	Coliform Agar Base Chromogenic Microinstant®	128
1.10449.0500	DNase Test Agar	01-346	DNase Agar	59
1.10453.0500	APT Agar	01-026	APT Agar	39
1.10455.0500	Columbia Agar Base	01-034	Blood Agar Base (Columbia)	45
1.10456.0500	Candida Selective Agar acc. to Nickerson	01-137	Nickerson Agar	88
1.10493.0500	Brain Heart Broth	02-599	Brain Heart Infusion Broth (BHI Broth)	46
1.10549.0500	Listeria Enrichment Broth (LEB) acc. to FDA/IDF-FIL	02-498	Listeria Enrichment Broth Base (Lovett)	75
1.10582.0500	Sodium Chloride peptone Broth Buffered	02-494	Buffered Peptone Water 0,1% (Eur. Pharm.)	50
1.10660.0500	MRS Agar	01-135	MRS Agar	85
1.10661.0500	MRS Broth	02-135	MRS Broth	85
1.10673.0500	Orange Serum Agar	01-698	Orange Serum Agar	90
1.10675.0500	Giolitti Cantoni Broth	02-230	Giolitti-Cantoni Broth	65
1.10707.0500	KF Streptococcus Agar Base	01-294	Kenner Fecal Agar (KF Agar)	69
1.10747.0500	BPLS Agar, mod	01-309	Brilliant Green Modified Agar	47
1.10756.0500	GN Enrichment Broth acc. to HAJNA	02-093	Gram Negative Broth (GN Broth)	66
1.10765.0500	EC Broth	02-060	E. coli Broth (EC Broth)	60
1.10859.0500	Tryptone Water	03-156	Tryptone Water	116
1.10860.0500	Dextrose Tryptone Agar	01-556	Dextrose Tryptone Purple Bromcresol Agar	58
1.10866.0500	WL Nutrient Agar	01-210	WL Nutrient Agar	122
1.10886.0500	Blood Agar Base	01-352	Blood Agar Base	44
1.10987.0500	Phenol-Red Broth Base	02-032	Phenol Red Broth Base	93
1.10988.0500	Pseudomonas Agar P Base	01-001	King A Agar (P Agar)	69
1.10989.0500	Pseudomonas Agar F Base	01-029	King B Agar (F Agar)	69
1.11640.0500	Lysine Iron Agar	01-094	Lysine Iron Agar (LIA)	78
1.11681.0500	Hektoen Enteric Agar	01-216	Hektoen Enteric Agar	67
1.11755.0500	Palcam Listeria Selective Agar Base acc. to Van Netten	01-470	Palcam Agar Base	91
1.11972.0500	TSC Agar	01-278	Tryptose Sulfite Cycloserine Agar (TSC Agar)	119
1.12523.1000	Lactalbumin hydrolyisate	07-455	Lactalbumin Hydrolysate	146
1.12535.0500	Maximum recovery Diluent	02-510	Maximum Recovery Diluent (MRD)	82
1.13825.0500	Brain Heart Agar	01-599	Brain Heart Infusion Agar (BHI Agar)	46
1.13919.0500	XLT4 Agar	01-708	XLT4 Agar Base	123
1.15338.0500	Plate Count Skim Milk Agar	01-412	Plate Count Skim Milk Agar	95
1.15363.0500	Skim Milk Powder	06-019	Skimmed Milk Powder	145, 146
1.16000.0500	YGC Agar (Yeast Extract Glucose Chloramphenicol Agar	01-366	Chloramphenicol Glucose Agar (CGA)	53
1.16122.0500	Chromocult TBX (Tryptone Bile X-glucuronide) Agar	01-619	Tryptone Bile Glucuronic Agar (TBX Agar) Microinstant®	130
335032ZF	Chromocult Listeria Enrichment Supplement	06-754	Microinstant® Listeria Enrichment Supplement	130

CROSS REFERENCES: OXOID – SCHARLAU (ALPHABETICAL)

ART. NO. OXOID	DESCRIPTION OXOID	ART. NO. SCHARLAU	DESCRIPTION SCHARLAU	PAGE
LP0011B	Agar bacteriological (Agar n.1)	07-004	Agar Bacteriological	146
CM1117B	Alkaline Saline Peptone Water	02-697	Peptone Water, Alkaline Saline	92
CM0327B	Antibiotic Medium n. 1	01-009	Antibiotic Medium A pH 6,6 (Eur. Pharm.)	37
CM0287B	Antibiotic Medium No. 3 (Assay Broth)	02-011	Antibiotic Medium C (Eur. Pharm.)	38
CM0868B	Azide Dextrose Broth (Rothe)	02-027	Azide Dextrose Broth (Rothe)	40
CM0617B	Bacillus Cereus Selective Agar Base	01-487	Bacillus cereus Selective Agar	41
CM0275B	Baird Parker Agar Base	01-030	Baird Parker Agar Base	41
CM0589B	BiGGY Agar	01-137	Nickerson Agar	88
CM0888B	Bile Aesculine agar	01-265	Bile Esculin Modified Agar	44
CM0055B	Blood Agar Base	01-352	Blood Agar Base	44
CM0271B	Blood Agar Base N. 2	01-505	Blood Agar Base No. 2	45
CM0983B	Bolton Selective Enrichment Broth	02-688	Bolton Enrichment Broth Base	45
CM0375B	Brain Heart Infusion Agar	01-599	Brain Heart Infusion Agar (BHI Agar)	46
CM0225B	Brain Heart Infusion Broth	02-599	Brain Heart Infusion Broth (BHI Broth)	46
CM0263B	Brilliant Green Agar	01-203	Brilliant Green Agar (BGA)	47
CM0329B	Brilliant Green Agar (Modified)	01-309	Brilliant Green Modified Agar	47
CM0031B	Brilliant Green Bile (2%) Broth	02-041	Brilliant Green Bile 2% Broth	47
CM1049B	Buffered Peptone Water (ISO)	02-277	Buffered Peptone Water (ISO)	49
CM0982B	Buffered sodium Chloride Peptone	02-494	Buffered Peptone Water 0,1% (Eur. Pharm.)	50
CM0739B	Campylobacter Blood-free Selective Agar Base	01-685	CCD Modified Agar (Charcoal Cefoperazone Deoxycholate)	52
CM0519B	Cary-Blair Medium	03-643	Cary-Blair Transport Medium	51
CM0579B	Cetrimide Agar	01-160	Cetrimide Agar (Eur. Pharm.)	52
CM0333B	Cholera Medium TCBS	01-567	TCBS Agar	108
CM0301B	CLED Medium	01-047	CLED Agar	54
CM0331B	Columbia Blood Agar Base	01-034	Blood Agar Base (Columbia)	45
CM0539B	Dermasel Medium	01-442	Dermatophytes Selective Agar	58
CM0163B	Desoxycholate Agar	01-057	Desoxycholate Lactose Agar	58
CM0729B	Dichloran Glycerol (DG18) Agar Base	01-485	DG 18 Agar	59
CM0321B	DNase Agar	01-346	DNase Agar	59
CM0727B	DRBC Agar Base	01-657	Dichloran Rose Bengal Chloramphenicol Agar	59
CM0853B	EC Broth	02-060	E. coli Broth (EC Broth)	60
CM0317B	EE Broth	02-064	Enrichment Enterobacteriaceae Broth (EE Broth)	61
BP351430X	Egg Yolk Tellurite Emulsion	06-026	Egg's Yolk Tellurite Sterile Emulsion	41, 144
SR0047C	Egg-Yolk Emulsion	06-016	Sterile Egg Yolk Emulsion	40, 41, 119, 144
CM0479B	Endo Agar Base	01-589	Endo Agar Base	60
CM0069B	Eosine Methylene Blue Agar, Modified Levine	01-068	Eosin Methylene Blue Agar (EMB Agar)	61
CM0523B	Giolitti Cantoni Broth	02-230	Giolitti-Cantoni Broth	65
CM0898B	Haemophilus Test Medium (HTM)	01-706	Haemophilus Test Agar Base (HTM)	66
CM0419B	Hektoen Enteric Agar	01-216	Hektoen Enteric Agar	67
CM0591B	Kanamycin Aesculin Azide Agar Base	01-263	Kanamycin Esculin Azide Agar (KAA Agar)	68
CM0701B	KF Streptococcus Agar	01-294	Kenner Fecal Agar (KF Agar)	69
CM0033B	Kligler Iron Agar	01-103	Kligler Iron Agar (KIA)	70
CM0015B	Lab-Lembco Broth	02-144	Nutrient Broth (APHA)	89
CM0017B	Lab-Lemco Agar	01-144	Nutrient Agar (APHA, ISO)	89
LP0029B	Lab-Lemco powder	07-075	Meat Extract	146
LP0048B	Lactalbumin hydrolysisate	07-455	Lactalbumin Hydrolysate	146
CM0137B	Lactose Broth	02-105	Lactose Broth	70
CM0451B	Lauryl Tryptose Broth	02-108	Tryptose Lauryl Sulfate Broth	117
CM0655B	Legionella CYE Agar Base	01-687	BCYE Legionella Agar Base	42, 43, 73
CM0862B	Listeria Enrichment Broth Base (FDA)	02-498	Listeria Enrichment Broth Base (Lovett)	75
CM0863B	Listeria Enrichment Broth Base (UVM formulation)	02-472	Listeria Enrichment Broth Base (UVM)	76
CM0895B	Listeria Enrichment Broth Base acc. to Fraser	02-496	Listeria Enrichment Broth Fraser	76
CM0856B	Listeria Selective Agar (OXFORD)	01-471	Oxford Agar Base	90
CM0308S	Lysine Decarboxylase Broth (Taylor Modification)	02-336	Decarboxylase Lysine Broth (Taylor)	57
CM0381B	Lysine Iron Agar	01-094	Lysine Iron Agar (LIA)	78
CM0115B	MacConkey Agar No. 3	01-118	MacConkey Agar (Eur. Pharm.)	78
CM0005B	MacConkey Broth	02-118	MacConkey Broth	78
CM0505B	MacConkey Broth Purple	02-611	MacConkey Broth (Eur. Pharm.)	79
LP0039B	Malt Extract	07-080	Malt Extract	146
CM0059B	Malt Extract Agar	01-574	Malt Extract Agar No. 3	80
CM0057B	Malt Extract Broth	02-491	Malt Extract Broth No. 2	81
CM0085B	Mannitol Salt Agar	01-116	Chapman Agar (Mannitol Salt Agar)	53
CM0733B	Maximum recovery Diluent	02-510	Maximum Recovery Diluent (MRD)	82
CM0992B	Membrane Clostridium Perfringens (m-CP) Medium	01-513	m-CP Agar Base	56
CM0681B	Milk Plate Count Agar	01-412	Plate Count Skim Milk Agar	95
CM0607G	Minerals Modified Medium Base	02-656	Mineral Modified Glutamate Medium Base	83
CM0910B	Modified Semi-Solid Rappaport-Vassiliadis (MSRV) Medium Base	03-376	Rappaport Vassiliadis Modified SemiSolid Medium Base	98
CM0361B	MRS Agar	01-135	MRS Agar	85

ART. NO. OXOID	DESCRIPTION OXOID	ART. NO. SCHARLAU	DESCRIPTION SCHARLAU	PAGE
CM0359B	MRS Broth	02-135	MRS Broth	85
CM0043B	MRVP Medium	02-207	Methyl Red Voges Proskauer Broth (MRVP Broth)	82
CM0337B	Mueller hinton Agar	01-136	Mueller-Hinton Agar	86
CM0405B	Mueller Hinton Broth	02-136	Mueller-Hinton Broth	87
CM1048B	Müller Kauffmann Tetrathionate-Novobiocin Broth (MKTn)	02-335	Müller-Kauffmann Tetrathionate Broth Base	87
CM0929B	MYP Agar	01-262	Bacillus cereus Agar	40
CM0003B	Nutrient Agar	01-140	Nutrient Agar	89
CM0001B	Nutrient Broth	02-140	Nutrient Broth (B.Ph.)	90
CM0067B	Nutrient Broth No.2 (Preston Selective Broth)	02-561	Preston Campylobacter Broth Base	96
CM0545B	Oxytetracyclin Glucose Yeast Extract Agar (O.G.Y.E Agar)	01-275	Sabouraud Oxytetracycline Agar (OGYEA)	104
CM0877B	Palcam Agar Base	01-470	Palcam Agar Base	91
CM0009B	Peptone Water	03-156	Tryptone Water	116
CM0587B	Perfringens Agar Base (TSC & SFP)	01-278	Tryptose Sulfite Cycloserine Agar (TSC Agar)	119
CM0325B	Plate Count Agar (Tryptone Glucose Yeast Agar)	01-329	Plate Count Modified Agar	94
SR0030J	Potassium tellurite 3,5%	06-011	Vogel Johnson Agar (VJ Agar)	122, 145
CM0139B	Potato Dextrose Agar	01-483	Potato Dextrose Agar (Eur. Pharm.)	95
CM0689B	Preston Selective Agar	01-451	Preston Campylobacter Agar Base	96
LP0085B	Proteose peptone	07-625	Proteose Peptone No. 3	146
CM0559B	Pseudomonas Agar Base	01-609	CN Selective Agar	55
CM0906B	R2A Agar	01-540	R2A Agar	97
CM0866B	Rappaport-Vassiliadis Soya Peptone (RVS) Broth	02-379	Rappaport Vassiliadis Broth	98
CM0669B	Rappaport-Vassiliadis (RV) Enrichment Broth	02-668	Rappaport Vassiliadis Salmonella Enrichment Broth	98
CM0151B	Reinforced Clostridial Agar	01-289	Reinforced Clostridial Agar	99
CM0149B	Reinforced Clostridial Medium	03-289	Reinforced Clostridial Medium (Eur. Pharm.)	99
CM0549B	Rose Bengal Chloramphenicol Agar	01-301	Rose Bengal Chloramphenicol Agar	100
CM0041B	Sabouraud Dextrose Agar	01-165	Sabouraud Dextrose Agar	103
CM0147B	Sabouraud Liquid Medium	02-165	Sabouraud Broth (Eur. Pharm.)	101
CM0533B	Salmonella Shigella Modificado Agar	01-555	Salmonella Shigella Agar (SS Agar)	104
CM0395B	Selenite Broth Base	02-598	Selenite Broth Base	105
CM0699B	Selenite Cystine Broth Base	02-602	Selenite Cystine Broth Base	106
CM0435B	SIM Medium	03-176	SIM Medium	106
CM0155B	SIMMONS Citrate Agar	01-177	Simmons Citrate Agar	106
LP0031B	Skim Milk Powder	06-019	Skimmed Milk Powder	145, 146
CM0377B	Slanetz & Bartley Medium	01-579	Slanetz Bartley Agar	107
CM0463B	Standard Plate Count Agar (APHA)	01-161	Plate Count Agar (PCA)	94
CM0111B	Stuart Transport Medium	03-454	Stuart Ringertz Transport Medium	108
CM0793B	Tergitol R 7 Agar	01-053	Chapman TTC Agar	53
CM0391B	Thioglycollate Broth USP-Alternative	02-186	Thioglycollate Broth	110
CM0173B	Thioglycollate Medium USP	03-187	Thioglycollate Fluid Medium	110
CM0189B	Todd-Hewitt Broth	02-191	Todd-Hewitt Broth	111
CM0277B	Triple Sugar Iron Agar	01-192	Triple Sugar Iron Agar (TSI Agar)	111
CM0989B	Tryptona Soya Broth Modified (mTSB)	02-691	Tryptic Soy Broth Modified	115
CM0595B	Tryptone Bile Agar	01-526	Tryptone Bile Agar	115
CM0945B	Tryptone Bile X-glucuronide Agar	01-619	Tryptone Bile Glucuronic Agar (TBX Agar) Microinstant®	130
CM0127B	Tryptone Glucose Extract Agar	01-082	Tryptone Glucose Extract Agar (TGE Agar)	115
CM0131B	Tryptone Soy Agar	01-200	Tryptic Soy Agar (TSA) (Eur. Pharm.)	112
CM0129B	Tryptone Soya Broth	02-200	Tryptic Soy Broth (TSB) (Eur. Pharm.)	114
LP0043B	Tryptone T	07-119	Tryptone - Casein Trypsic Peptone	146
LP0047B	Tryptose	07-197	Tryptose	146
SR0229K	TTC Solution (1%)	06-023	TTC Sterile Solution 1%	53, 69, 107, 145
CM0053B	Urea Agar Base	01-261	Urea Agar Base	120
CM0071B	Urea Broth Base	02-202	Urea Broth Base	120
SR0020K	Urea Steril Solution 40%	06-083	Urea Agar Base	91, 145
CM0485B	Violet Red Bile Glucose Agar	01-295	Violet Red Bile Dextrose Agar (VRBD Agar) (Eur. Pharm.)	121
CM0107B	Violet Red Bile Lactose Agar	01-164	Violet Red Bile Agar (VRB Agar)	121
CM0641B	Vogel Johnson Agar	01-206	Vogel Johnson Agar (VJ Agar)	122
CM1012B	Water Plate Count Agar (ISO)	01-590	Tryptone Yeast Extract Agar	117
CM0309B	WL Nutrient Agar (Medium)	01-210	WL Nutrient Agar	122
CM0247B	Wort Agar	01-132	Wort Agar	123
CM0469B	XLD Medium	01-552	Xylose Lysine Deoxycholate Modified Agar	124
LP0021B	Yeast Extract powder	07-079	Yeast Extract	146
CM0920B	Yeast Mold Agar (YM Agar)	01-219	Yeast Malt Agar (YM Agar)	125
CM0653B	Yersinia Selective (CIN) Agar Base	01-444	Yersinia CIN Agar Base	126

CROSS REFERENCES: OXOID – SCHARLAU (NUMERICAL)

ART. NO. OXOID	DESCRIPTION OXOID	ART. NO. SCHARLAU	DESCRIPTION SCHARLAU	PAGE
BP351430X	Egg Yolk Tellurite Emulsion	06-026	Egg's Yolk Tellurite Sterile Emulsion	41, 144
CM0001B	Nutrient Broth	02-140	Nutrient Broth (B.Ph.)	90
CM0003B	Nutrient Agar	01-140	Nutrient Agar	89
CM0005B	MacConkey Broth	02-118	MacConkey Broth	78
CM0009B	Peptone Water	03-156	Tryptone Water	116
CM0015B	Lab-Lembco Broth	02-144	Nutrient Broth (APHA)	89
CM0017B	Lab-Lemco Agar	01-144	Nutrient Agar (APHA, ISO)	89
CM0031B	Brilliant Green Bile (2%) Broth	02-041	Brilliant Green Bile 2% Broth	47
CM0033B	Kligler Iron Agar	01-103	Kligler Iron Agar (KIA)	70
CM0041B	Sabouraud Dextrose Agar	01-165	Sabouraud Dextrose Agar	103
CM0043B	MRVP Medium	02-207	Methyl Red Voges Proskauer Broth (MRVP Broth)	82
CM0053B	Urea Agar Base	01-261	Urea Agar Base	120
CM0055B	Blood Agar Base	01-352	Blood Agar Base	44
CM0057B	Malt Extract Broth	02-491	Malt Extract Broth No. 2	81
CM0059B	Malt Extract Agar	01-574	Malt Extract Agar No. 3	80
CM0067B	Nutrient Broth No.2 (Preston Selective Broth)	02-561	Preston Campylobacter Broth Base	96
CM0069B	Eosine Methylene Blue Agar, modified Levine	01-068	Eosin Methylene Blue Agar (EMB Agar)	61
CM0071B	Urea Broth Base	02-202	Urea Broth Base	120
CM0085B	Mannitol Salt Agar	01-116	Chapman Agar (Mannitol Salt Agar)	53
CM0107B	Violet Red Bile Lactose Agar	01-164	Violet Red Bile Agar (VRB Agar)	121
CM0111B	Stuart Transport Medium	03-454	Stuart Ringertz Transport Medium	108
CM0115B	MacConkey Agar No. 3	01-118	MacConkey Agar (Eur. Pharm.)	78
CM0127B	Tryptone Glucose Extract Agar	01-082	Tryptone Glucose Extract Agar (TGE Agar)	115
CM0129B	Tryptone Soya Broth	02-200	Tryptic Soy Broth (TSB) (Eur. Pharm.)	114
CM0131B	Tryptone Soy Agar	01-200	Tryptic Soy Agar (TSA) (Eur. Pharm.)	112
CM0137B	Lactose Broth	02-105	Lactose Broth	70
CM0139B	Potato Dextrose Agar	01-483	Potato Dextrose Agar (Eur. Pharm.)	95
CM0147B	Sabouraud Liquid Medium	02-165	Sabouraud Broth (Eur. Pharm.)	101
CM0149B	Reinforced Clostridial Medium	03-289	Reinforced Clostridial Medium (Eur. Pharm.)	99
CM0151B	Reinforced Clostridial Agar	01-289	Reinforced Clostridial Agar	99
CM0155B	Simmons Citrate Agar	01-177	Simmons Citrate Agar	106
CM0163B	Desoxycholate Agar	01-057	Deoxycholate Lactose Agar	58
CM0173B	Thioglycollate Medium USP	03-187	Thioglycollate Fluid Medium	110
CM0189B	Todd-Hewitt Broth	02-191	Todd-Hewitt Broth	111
CM0225B	Brain Heart Infusion Broth	02-599	Brain Heart Infusion Broth (BHI Broth)	46
CM0247B	Wort Agar	01-132	Wort Agar	123
CM0263B	Brilliant Green Agar	01-203	Brilliant Green Agar (BGA)	47
CM0271B	Blood Agar Base N. 2	01-505	Blood Agar Base No. 2	45
CM0275B	Baird Parker Agar Base	01-030	Baird Parker Agar Base	41
CM0277B	Triple Sugar Iron Agar	01-192	Triple Sugar Iron Agar (TSI Agar)	111
CM0287B	Antibiotic Medium No. 3 (Assay Broth)	02-011	Antibiotic Medium C (Eur. Pharm.)	38
CM0301B	CLED Medium	01-047	CLED Agar	54
CM0308S	Lysine Decarboxylase Broth (Taylor Modification)	02-336	Decarboxylase Lysine Broth (Taylor)	57
CM0309B	WL Nutrient Agar (Medium)	01-210	WL Nutrient Agar	122
CM0317B	EE Broth	02-064	Enrichment Enterobacteriaceae Broth (EE Broth)	61
CM0321B	DNase Agar	01-346	DNase Agar	59
CM0325B	Plate Count Agar (Tryptone Glucose Yeast Agar)	01-329	Plate Count Modified Agar	94
CM0327B	Antibiotic Medium N. 1	01-009	Antibiotic Medium A pH 6,6 (Eur. Pharm.)	37
CM0329B	Brilliant Green Agar (Modified)	01-309	Brilliant Green Modified Agar	47
CM0331B	Columbia Blood Agar Base	01-034	Blood Agar Base (Columbia)	45
CM0333B	Cholera Medium TCBS	01-567	TCBS Agar	108
CM0337B	Mueller Hinton Agar	01-136	Mueller-Hinton Agar	86
CM0359B	MRS Broth	02-135	MRS Broth	85
CM0361B	MRS Agar	01-135	MRS Agar	85
CM0375B	Brain Heart Infusion Agar	01-599	Brain Heart Infusion Agar (BHI Agar)	46
CM0377B	Slanetz & Bartley Medium	01-579	Slanetz Bartley Agar	107
CM0381B	Lysine Iron Agar	01-094	Lysine Iron Agar (LIA)	78
CM0391B	Thioglycollate Broth USP-Alternative	02-186	Thioglycollate Broth	110
CM0395B	Selenite Broth Base	02-598	Selenite Broth Base	105
CM0405B	Mueller Hinton Broth	02-136	Mueller-Hinton Broth	87
CM0419B	Hektoen Enteric Agar	01-216	Hektoen Enteric Agar	67
CM0435B	SIM Medium	03-176	SIM Medium	106
CM0451B	Lauryl Tryptose Broth	02-108	Tryptose Lauryl Sulfate Broth	117
CM0463B	Standard Plate Count Agar (APHA)	01-161	Plate Count Agar (PCA)	94
CM0469B	XLD Medium	01-552	Xylose Lysine Deoxycholate Modified Agar	124
CM0479B	Endo Agar Base	01-589	Endo Agar Base	60
CM0485B	Violet Red Bile Glucose Agar	01-295	Violet Red Bile Dextrose Agar (VRBD Agar) (Eur. Pharm.)	121
CM0505B	MacConkey Broth Purple	02-611	MacConkey Broth (Eur. Pharm.)	79

ART. NO. OXOID	DESCRIPTION OXOID	ART. NO. SCHARLAU	DESCRIPTION SCHARLAU	PAGE
CM0519B	Cary-Blair Medium	03-643	Cary-Blair Transport Medium	51
CM0523B	Giolitti Cantoni Broth	02-230	Giolitti-Cantoni Broth	65
CM0533B	Salmonella Shigella Modificado Agar	01-555	Salmonella Shigella Agar (SS Agar)	104
CM0539B	Dermasel Medium	01-442	Dermatophytes Selective Agar	58
CM0545B	Oxytetracyclin Glucose Yeast Extract Agar (O.G.Y.E Agar)	01-275	Sabouraud Oxytetracycline Agar (OGYEA)	104
CM0549B	Rose Bengal Chloramphenicol Agar	01-301	Rose Bengal Chloramphenicol Agar	100
CM0559B	Pseudomonas Agar Base	01-609	CN Selective Agar	55
CM0579B	Cetrimide Agar	01-160	Cetrimide Agar (Eur. Pharm.)	52
CM0587B	Perfringens Agar Base (TSC & SFP)	01-278	Tryptose Sulfite Cycloserine Agar (TSC Agar)	119
CM0589B	BiGGY Agar	01-137	Nickerson Agar	88
CM0591B	Kanamycin Aesculin Azide Agar Base	01-263	Kanamycin Esculin Azide Agar (KAA Agar)	68
CM0595B	Tryptone Bile Agar	01-526	Tryptone Bile Agar	115
CM0607G	Minerals Modified Medium Base	02-656	Mineral Modified Glutamate Medium Base	83
CM0617B	Bacillus Cereus Selective Agar Base	01-487	Bacillus cereus Selective Agar	41
CM0641B	Vogel Johnson Agar	01-206	Vogel Johnson Agar (VJ Agar)	122
CM0653B	Yersinia Selective (CIN) Agar Base	01-444	Yersinia CIN Agar Base	126
CM0655B	Legionella CYE Agar Base	01-687	BCYE Legionella Agar Base	42, 43, 73
CM0669B	Rappaport-Vassiliadis (RV) Enrichment Broth	02-668	Rappaport Vassiliadis Salmonella Enrichment Broth	98
CM0681B	Milk Plate Count Agar	01-412	Plate Count Skim Milk Agar	95
CM0689B	Preston Selective Agar	01-451	Preston Campylobacter Agar Base	96
CM0699B	Selenite Cystine Broth Base	02-602	Selenite Cystine Broth Base	106
CM0701B	KF Streptococcus Agar	01-294	Kenner Fecal Agar (KF Agar)	69
CM0727B	DRBC Agar Base	01-657	Dichloran Rose Bengal Chloramphenicol Agar	59
CM0729B	Dichloran Glycerol (DG18) Agar Base	01-485	DG 18 Agar	59
CM0733B	Maximum recovery Diluent	02-510	Maximum Recovery Diluent (MRD)	82
CM0739B	Campylobacter Blood-free Selective Agar Base	01-685	CCD Modified Agar (Charcoal Cefoperazone Deoxycholate)	52
CM0793B	Tergitol R 7 Agar	01-053	Chapman TTC Agar	53
CM0853B	EC Broth	02-060	E. coli Broth (EC Broth)	60
CM0856B	Listeria Selective Agar (Oxford)	01-471	Oxford Agar Base	90
CM0862B	Listeria Enrichment Broth Base (FDA)	02-498	Listeria Enrichment Broth Base (Lovett)	75
CM0863B	Listeria Enrichment Broth Base (UVM formulation)	02-472	Listeria Enrichment Broth Base (UVM)	76
CM0866B	Rappaport-Vassiliadis Soya Peptone (RVS) Broth	02-379	Rappaport Vassiliadis Broth	98
CM0868B	Azide Dextrose Broth (Rothe)	02-027	Azide Dextrose Broth (Rothe)	40
CM0877B	Palcam Agar Base	01-470	Palcam Agar Base	91
CM0888B	Bile Aesculine agar	01-265	Bile Esculin Modified Agar	44
CM0895B	Listeria Enrichment Broth Base acc. to Fraser	02-496	Listeria Enrichment Broth Fraser	76
CM0898B	Haemophilus Test Medium (HTM)	01-706	Haemophilus Test Agar Base (HTM)	66
CM0906B	R2A Agar	01-540	R2A Agar	97
CM0910B	Modified Semi-Solid Rappaport-Vassiliadis (MSRV) Medium Base	03-376	Rappaport Vassiliadis Modified SemiSolid Medium Base	98
CM0920B	Yeast Mold Agar (YM Agar)	01-219	Yeast Malt Agar (YM Agar)	125
CM0929B	MYP Agar	01-262	Bacillus cereus Agar	40
CM0945B	Tryptone Bile X-glucuronide Agar	01-619	Tryptone Bile Glucuronic Agar (TBX Agar) Microinstant®	130
CM0982B	Buffered sodium Chloride Peptone	02-494	Buffered Peptone Water 0,1% (Eur. Pharm.)	50
CM0983B	Bolton Selective Enrichment Broth	02-688	Bolton Enrichment Broth Base	45
CM0989B	Tryptona Soya Broth Modified (mTSB)	02-691	Tryptic Soy Broth Modified	115
CM0992B	Membrane Clostridium Perfringens (m-CP) Medium	01-513	m-CP Agar Base	56
CM1012B	Water Plate Count Agar (ISO)	01-590	Tryptone Yeast Extract Agar	117
CM1048B	Müller Kauffmann tetrathionate-Novobiocin Broth (MKTTn)	02-335	Müller-Kauffmann Tetrathionate Broth Base	87
CM1049B	Buffered Peptone Water (ISO)	02-277	Buffered Peptone Water (ISO)	49
CM1117B	Alkaline Saline Peptone Water	02-697	Peptone Water, Alkaline Saline	92
LP0011B	Agar bacteriological (Agar N.1)	07-004	Agar Bacteriological	146
LP0021B	Yeast Extract powder	07-079	Yeast Extract	146
LP0029B	Lab-Lemco powder	07-075	Meat Extract	146
LP0031B	Skim Milk Powder	06-019	Skimmed Milk Powder	145, 146
LP0039B	Malt Extract	07-080	Malt Extract	146
LP0043B	Tryptone T	07-119	Tryptone - Casein Trypsic Peptone	146
LP0047B	Tryptose	07-197	Tryptose	146
LP0048B	Lactalbumin hydrolysate	07-455	Lactalbumin Hydrolysate	146
LP0085B	Proteose peptone	07-625	Proteose Peptone No. 3	146
SR0020K	Urea Steril Solution 40%	06-083	Urea Agar Base	91, 145
SR0030J	Potassium tellurite 3,5%	06-011	Vogel Johnson Agar (VJ Agar)	122, 145
SR0047C	Egg-Yolk Emulsion	06-016	Sterile Egg Yolk Emulsion	40, 41, 119, 144
SR0229K	TTC Solution (1%)	06-023	TTC Sterile Solution 1%	53, 69, 107, 145

DESCRIPTION	PAGE
A	
A1 Broth	36
Acetamide medium	36
n-Acetylcysteine	144
Additives for culture media	144
AGS	39
➤ AK 2 Agar	107
➤ AK Agar	107
Algae Agar	36
Algae Broth	37
➤ All Purpose Polysorbate Agar	39
➤ All Purpose Tween® Agar	39
➤ AM1	37
➤ AM11	37
Ampicillin Selective Supplement	148
➤ Antibiotic Assay Broth	38
➤ Antibiotic Medium 1	37
➤ Antibiotic Medium 10	37
➤ Antibiotic Medium 11	37
➤ Antibiotic Medium 19	38
➤ Antibiotic Medium 3 (USP)	38
➤ Antibiotic Medium 32 (USP)	107
Antibiotic Medium A pH 6,6 (Eur. Pharm.)	37
Antibiotic Medium A pH 7,9 (Eur. Pharm.)	37
Antibiotic Medium B (Eur. Pharm.)	37
Antibiotic Medium C (Eur. Pharm.)	38
Antibiotic Medium E (Eur. Pharm.)	38
Antibiotic Medium F (Eur. Pharm.)	38
Antibiotic Medium No. 3	38
Antibiotic Medium No. 8	39
➤ AOAC Lethen Agar	73
APT Agar	39
AquaCHROM™ ECC	132
Arginine Glucose Agar	39
➤ Arret & Kirshbaum Agar	107

DESCRIPTION	PAGE
Asparagine Broth	39
Aspergillus brasiliensis ATCC® 16404™/ WDCM 00053	153, 154, 155
➤ ASPW	92
➤ Azide Agar	107
Azide Dextrose Broth (Rothe)	40
Azide Ethyl Violet Broth (EVA Broth)	40
B	
Bacillus cereus Agar	40
Bacillus cereus ATCC® 11778™/ WDCM 00001	153
Bacillus cereus Selective Agar	41
Bacillus subtilis subsp. spizizenii ATCC® 6633™/ WDCM 00003	153, 154, 155
➤ Bacteriological Peptone 0.1%	63
Baird Parker Agar Base	41
Baird Parker RPF Agar	41
BAT Agar	42
BAT Broth	42
➤ BCP Agar	58
➤ BCSA	51
BCSA, see Burkholderia cepacia Selective Agar Base	51
BCYE Legionella Agar Base	42
BCYE Legionella Selective, see Legionella Selective (GVPC) Agar (ISO)	73
BCYE Legionella without Cysteine	43
BCYE+AB Legionella Selective Agar (ISO)	43
BEA, see Bile Esculin Azide Agar	44
Beerens Cosmetic Diluent	43
➤ BEM	44
➤ BGA Modified	47
BGA Modified, see Brilliant Green Modified Agar	47
➤ BGA	47
BGA, see Brilliant Green Agar	46
➤ BGBL Broth	47
BGBL, see Brilliant Green Bile 2%	47
➤ BGBLB	47
BHI Agar, see Brain Heart Infusion Agar	45
BHI Broth, see Brain Heart Infusion Broth	46

➤ This index contains synonymous names of products to facilitate your search. They are marked with a green arrow. In the catalogue they are next to the product name.

DESCRIPTION	PAGE
➤ BiGGY Agar	88
BIGGY Agar, see Nickerson Agar	88
➤ Bile Esculin Agar	44
Bile Esculin Azide Agar	44
Bile Esculin Modified Agar	44
➤ Bile Esculin Medium	44
➤ Bismuth Glycine Glucose Yeast Agar	88
➤ BLBVB	47
Blood Agar Base	44
Blood Agar Base (Columbia)	45
Blood Agar Base Modified	45
Blood Agar Base No. 2	45
Bolton Enrichment Broth Base	45
➤ BP Agar	41
➤ BPLA	47
Brain Heart Infusion (BHI) Supplemented with SPS (0,05%)	46
Brain Heart Infusion Agar (BHI Agar)	46
Brain Heart Infusion Broth (BHI Broth)	46
Brettanomyces Agar	46
Brilliant Green + Novobiocin Selective Supplement	148
Brilliant Green Agar (BGA)	47
Brilliant Green Bile 2% Broth	47
Brilliant Green Modified Agar	47
➤ Brilliant Green Phenol Red Lactose Agar	47
➤ Brolacin agar	54
Brucella Farrell Agar (Modified)	48
Buffer Phosphate pH 7,2 (0.05M)	48
Buffered Peptone Phosphate Water	48
Buffered Peptone Water (Eur. Pharm.) + 0,1% Histidin + 0,3% Lecithin + 3% Polysorbate 80	48
Buffered Peptone Water (ISO)	49
Buffered Peptone Water 0,1% (Eur. Pharm.)	50
➤ Buffered Peptone Water 0.1%	50
Buffered Peptone Water Modified	51
➤ Buffered Saline Peptone Water	50
➤ Buffered Sodium Chloride Peptone Solution pH 7,0	50

➤ This index contains synonymous names of products to facilitate your search. They are marked with a green arrow. In the catalogue they are next to the product name.

DESCRIPTION	PAGE
Burkholderia cepacea ATCC® 25416™	153, 154
Burkholderia cepacia Selective Agar Base (BCSA)	51
Burkholderia cepacia Selective Agar Base (OFFPBL Base)	51
Burkholderia cepacia Selective Supplement	148
Burkholderia cepacia Selective Supplement (OFFPBL)	148
C	
➤ C Agar	45
➤ CA	45
➤ Campylobacter Blood-Free Selective Agar	52
Campylobacter Bolton Selective Supplement	148
Campylobacter CCDA Selective Supplement	148
Campylobacter jejuni subsp. jejuni ATCC® 33291™/ WDCM 00005	153
Candida albicans ATCC® 10231™/ WDCM 00054	153, 154, 155
Cary-Blair Transport Medium	51
Casein Lecithin Polysorbate, Broth base	52
➤ Casein Soya bean Digest Broth	114
➤ Casein Soybean Digest Agar	112
➤ CB Agar	45
CCA (ISO), see Coliform Agar Base (ISO) Chromogenic Microinstant®	128
CCA, see Coliform Agar Base Chromogenic Microinstant®	128
CCD Modified Agar (Charcoal Cefoperazone Deoxycholate)	52
➤ CCD Modified Agar	52
CCDA, see CCD Modified Agar	52
➤ Cefsulodin-Irgasan®-Novobiocin Agar Base	126
Cetrimide Agar (Eur. Pharm.)	52
➤ Cetrimide-Nalidixic Acid Medium	55
Cetrimide-Nalidixic Acid Medium, see CN Selective Agar	55
CFC Agar, see Pseudomonas CFC Agar	96
CFC Pseudomonas Selective Supplement	148
CGA, see Chloramphenicol Glucose Agar	53
Chapman Agar (Mannitol Salt Agar)	53
➤ Chapman Agar	53
Chapman TTC Agar	53
Chloramphenicol Glucose Agar (CGA)	53
Chloramphenicol Selective Supplement	148

DESCRIPTION	PAGE
C (CONTINUATION)	
Chocolate Agar - Supplemented	54
➤ Cholera Medium TCBS	108
➤ Christensen Agar	120
Christensen's Citrate Agar	54
CHROMagar™ VRE	140
CHROMagar™ Acinetobacter	132
CHROMagar™ B. cereus	133
CHROMagar™ C. difficile	134
CHROMagar™ C. perfringens	134
CHROMagar™ C3GR	133
CHROMagar™ Campylobacter	133
CHROMagar™ Candida	133
CHROMagar™ CCA	134
CHROMagar™ E. coli	135
CHROMagar™ E. sakazakii	135
CHROMagar™ ECC	134
CHROMagar™ Enterobacteria	135
CHROMagar™ ESBL	135
CHROMagar™ Identification Listeria	136
CHROMagar™ KPC	136
CHROMagar™ Liquid ECC	136
CHROMagar™ Listeria	136
CHROMagar™ Malassezia	137
CHROMagar™ Mastitis	137
CHROMagar™ MRSA	137
CHROMagar™ mSuperCARBA™	137
CHROMagar™ O157	138
CHROMagar™ Orientation	138
CHROMagar™ Pseudomonas	138
CHROMagar™ Salmonella	138
CHROMagar™ Salmonella Plus	139
CHROMagar™ Staph aureus	139
CHROMagar™ Staphylococcus	139
CHROMagar™ STEC	139

DESCRIPTION	PAGE
CHROMagar™ Strep B	140
CHROMagar™ Streptococcus	140
CHROMagar™ Vibrio	140
CHROMagar™ Yersinia enterocolitica	141
Chromogenic Media CHROMagar™	132
Chromogenic media Compact Dry®	142
Chromogenic media Microinstant®	128
CIN Agar, see Yersinia CIN Agar Base	126
Citrobacter freundii ATCC® 43864™/ WDCM 00006	153
➤ Clarks Lubs Medium	82
CLED Agar	54
Clostridium perfringens ATCC® 13124™/ WDCM 00007	153
Clostridium perfringens Selective Agar (SPS Agar)	55
Clostridium sporogenes ATCC® 19404™/ WDCM 00008	153, 155
➤ CLS Base	71
➤ CN Medium	55
➤ CN Pseudomonas Agar	55
CN Pseudomonas Selective Supplement	148
CN Selective Agar	55
CNA, see Columbia CNA Agar Base	56
Coliform Agar Base (ISO) Chromogenic Microinstant®	128
Coliform Agar Base Chromogenic Microinstant®	128
Coliform CV Selective Supplement	148
Colinstant Agar Chromogenic Microinstant®	129
➤ Colony Count Agar	115
Columbia Agar (Eur. Pharm)	55
Columbia Blood Agar	45
Columbia CNA Agar Base	56
Compact Dry® AQ	142
Compact Dry® CF (Coliforms)	142
Compact Dry® EC (Coliforms and E. coli)	142
Compact Dry® ETB (Enterobacterias)	142
Compact Dry® ETC (Enterococos)	142
Compact Dry® LS (Listeria spp.)	142
Compact Dry® PA	143

➤ This index contains synonymous names of products to facilitate your search. They are marked with a green arrow. In the catalogue they are next to the product name.

DESCRIPTION	PAGE
Compact Dry® SL (Salmonella)	143
Compact Dry® swabs for surfaces	143
Compact Dry® TC (Total counting)	143
Compact Dry® VP (Vibrio parahaemolyticus)	143
Compact Dry® X-BC (Bacillus cereus)	143
Compact Dry® XSA (Staphylococcus aureus)	143
Compact Dry® YM rapid (Moulds and yeasts)	143
m-CP Agar Base	56
m-CP Selective Supplement	148
Cronobacter Isolation Agar (CCI) Chromogenic Microinstant®	129
Cronobacter Selective Broth base (CSB) Microinstant®	56
CT SMAC Selective Supplement	148
Cycloheximide Selective Supplement	148
d-Cycloserine Selective Supplement	148
➤ CYE	42, 73
➤ CYE w/o Cys	43
➤ Cystine Lactose Electrolyte Deficient Agar	54
Czapek-Dox Agar	56
D	
D/E Neutralizing Agar Base	57
D/E Neutralizing Broth Base	57
➤ DCL Agar	58
Decarboxylase Lysine Broth (Taylor)	57
Dehydrated and prepared culture media	36
Deoxycholate Citrate Modified Agar according to Hynes	57
Deoxycholate Lactose Agar	58
➤ Deoxyribonuclease Test Agar	59
➤ Deoxyribonucleic Acid Agar	59
➤ Dermatophytes Medium Test	58
Dermatophytes Selective Agar	58
Dextrose Tryptone Purple Bromcresol Agar	58
➤ Dey-Engley Neutralizing Agar	57
DG 18 Agar	59
DG 18 Metal Agar	59
Dichloran Rose Bengal Chloramphenicol Agar	59

DESCRIPTION	PAGE
➤ Dichloran-Glycerol 18 Agar	59
➤ DNA Agar	59
DNase Agar	59
➤ Dnase Test Agar	59
➤ DRBC Agar	59
DRCM, see Reinforced Clostridial Medium Differential	99
Drigalsky Lactose Agar	60
➤ DTM Agar	58
DTM, see Dermatophytes Selective Agar	58
E	
E. coli Broth (EC Broth)	60
➤ EC Broth	60
EE Broth, see Enrichment Enterobacteriaceae Broth	61
➤ EE Mossel	61
➤ Egg Yolk Tellurite Glycine Piruvate Agar	41
Egg's Yolk sterile Emulsion	144
Egg's Yolk Tellurite sterile Emulsion	144
EMB Agar, see Enrichment Enterobacteriaceae Broth	61
Endo Agar Base	60
Endo LES Agar	61
Enrichment Enterobacteriaceae Broth (EE Broth)	61
Enterobacter aerogenes ATCC® 13048™/ WDCM 00175	153
➤ Enterococcus Agar	107
Enterococcus faecalis ATCC® 29212™/ WDCM 00087	153, 154
Eosin Methylene Blue Agar (EMB Agar)	61
➤ Erythromycin Assay Agar	37
Escherichia coli ATCC® 25922™/ WDCM 00013	153
Escherichia coli ATCC® 8739™/ WDCM 00012	153, 154, 155
ESIA Broth, see Sakazakii Agar Chromogenic Microinstant®	130
➤ ETGP Agar	41
➤ Ethyl Violet Azide Broth (EVA Broth)	40
Eugon LT Modified Agar	62
Eugon LT Modified Broth	62
➤ Eur Pharm. Agar Medium F	121
EVA Broth, see Azide Ethyl Violet Broth	40

➤ This index contains synonymous names of products to facilitate your search. They are marked with a green arrow. In the catalogue they are next to the product name.

DESCRIPTION	PAGE
F	
➤ F Agar	69
➤ F Thio M	110
m-FC Agar, see Fecal Coliforms Agar	62
Fecal Coliforms Agar (m-FC Agar)	62
Ferric Ammonium Citrate Supplement	148
➤ FIO Agar	69
Fluid A	63
Fluid A 0.1% + buffer	63
Fluid D	63
Fluid K	64
➤ Fluorescein Agar	69
Fraser Listeria Enrichment Broth, see Listeria Enrichment Broth Fraser	76
FTM, see Thioglycollate Fluid Medium	110
G	
GBS Modified Agar	64
GC Agar Base	64
Giolitti-Cantoni Broth	65
Glucose Bromocresol Purple Agar	65
Glucose Peptone Chloramphenicol Agar (GP Agar with Antibiotic)	65
GN Broth, see Gram Negative Broth	66
➤ GN Enrichment Broth	66
GPS - Growth Promotion Supplement	148
Gram Negative Broth (GN Broth)	66
m-Green Agar	66
m-Green Broth	66
➤ m-GREEN YEAST & MOULD Agar	66
➤ m-Green yeast & Mould Broth	66
GVPC, see Legionella Selective (GVPC) Agar (ISO)	73
H	
Haemophilus Test Agar Base (HTM)	66
➤ Haemophilus Test Medium Agar Base	66
➤ Haemophilus Test Medium	66
➤ Hajna Broth	66
HC Agar Base	67

DESCRIPTION	PAGE
➤ HE Agar	67
➤ HEA	67
Hektoen Enteric Agar	67
HTM, see Haemophilus Test Agar Base	66
➤ Hugh & Leifson Medium	91
I	
Ingredients and chemical products for microbiology	146
Iodine Potassium-Iodide Solution	144
➤ Iron Agar	70
Iron Sulfite Modified Agar	67
K	
K Agar	68
KAA Agar, see Kanamycin Esculin Azide Agar	68
KAA Broth, see Kanamycin Esculin Azide Broth	68
Kanamycin Esculin Azide Agar (KAA Agar)	68
Kanamycin Esculin Azide Broth (KAA Broth)	68
Kenner Fecal Agar (KF Agar)	69
KF Agar, see Kenner Fecal Agar	69
KIA, see Kligler Iron Agar	70
King A Agar (P Agar)	69
➤ King A Medium	69
King B Agar (F Agar)	69
Kligler Iron Agar (KIA)	70
➤ Kligler's Iron Agar	70
L	
β-Lactamase Penase 20.000 UL/ml	144
➤ Lactobacilli MRS Agar	85
➤ Lactobacilli MRS Broth	85
Lactobacillus acidophilus ATCC® 4356™/ WDCM 00098	153
Lactobacillus sakei subsp. sakei ATCC® 15521™/ WDCM 00015	153
Lactose Broth	70
Lactose Broth Phenol Red (Double Concentration+ Durham Tube)	70
Lactose Gelatin Medium	71
Lactose Sulfite Broth Base	71
Lactose TTC Heptadecyl Sodic Sulfate Agar	53

➤ This index contains synonymous names of products to facilitate your search. They are marked with a green arrow. In the catalogue they are next to the product name.

DESCRIPTION	PAGE
m-Lauryl Sulfate Agar	71
Lauryl Sulfate MUG Broth	72
LB Agar (Miller)	72
LB Broth	72
LB Broth (Lennox)	72
LB Broth (Miller)	73
Legionella anisa ATCC® 35292™/ WDCM 00106	153
Legionella BCYE Growth Supplement	148
Legionella BCYE without Cysteine Supplement	148
Legionella GVPC Selective Supplement	148
Legionella p. sub.pneumophila ATCC® 33152™/ WDCM 00107	153
Legionella Selective (GVPC) Agar (ISO)	73
Lethen Agar	73
Lethen Broth	74
Lethen Modified Agar	74
Lethen Modified Broth	74
Lethen Modified Broth (FDA)	75
➤ Levine Agar	61
LIA, see Lysine Iron Agar	78
Liebermeister & Braveny Agar	75
Linden Grain Broth	75
Listeria Enrichment Broth Base (Lovett)	75
Listeria Enrichment Broth Base (UVM)	76
Listeria Enrichment Broth Fraser	76
Listeria innocua ATCC® 33090™/ WDCM 00017	153
Listeria monocytogenes ATCC® 13932™/ WDCM 00021	153
Listeria Ottaviani & Agosti Agar Microinstant®	130
Listeria Ottaviani & Agosti Agar, see Listeria Ottaviani & Agosti Agar Microinstant®	130
Listeria Selective Supplement for Enrichment (FDA and IDF/FIL)	150
Listeria Selective Supplement for Primary Enrichment (UVM I)	150
Listeria Selective Supplement for Primary Enrichment Half Fraser	150
Listeria Selective Supplement for Primary Enrichment Half Fraser	150
Listeria Selective Supplement for Secondary Enrichment (UVM II / Fraser)	150
Listeria Selective Supplement for Secondary Enrichment (UVM II / Fraser) with Ferric Ammonium Citrate	150
➤ Litsky Broth	40

DESCRIPTION	PAGE
Lovett (Listeria Enrichment Broth Base), see Listeria Enrichment Broth Base (Lovett)	75
Löwenstein-Jensen Medium Base	77
Löwenstein-Jensen Pyruvate Medium	77
LST, see Tryptose Lauryl Sulfate Modified Base Broth	118
Lysine Agar	77
Lysine Iron Agar (LIA)	78
M	
➤ M-H Agar	86
M17 Agar	78
MacConkey Agar (Eur. Pharm.)	78
MacConkey Broth	78
MacConkey Broth (Eur. Pharm.)	79
➤ MacConkey Dextrose Agar	121
MacConkey No. 2 Agar	79
MacConkey Sorbitol Agar (Modified)	79
Malt Extract Agar (Blakeslee)	79
Malt Extract Agar No. 1	80
Malt Extract Agar No. 2	80
Malt Extract Agar No. 3	80
Malt Extract Broth No. 1	80
Malt Extract Broth No. 2	81
➤ Man Rogose Sharpe Broth	85
Mannitol Motility Test	81
Mannitol Salt Agar, see Chapman Agar	53
➤ Mannitol-Egg Yolk-Polymyxin Agar	40
Marine Agar	81
Maximum Recovery Diluent (MRD)	82
➤ mCCDA	52
➤ Media M10	92
➤ Medium 1	37
➤ Medium 10	37
➤ Medium 11	37
➤ Medium 19	38
➤ Medium 6	79
➤ Medium A according to Eur. Pharm. 5th Ed.	114

➤ This index contains synonymous names of products to facilitate your search. They are marked with a green arrow. In the catalogue they are next to the product name.

DESCRIPTION	PAGE
M (CONTINUATION)	
➤ Medium A Eur. Pharm. 5th Ed.	50
➤ Medium A	37
➤ Medium B of the Eur. Pharm. 5th Ed.	112
➤ Medium C	37, 38
➤ Medium E Eur. Pharm. 5th Ed.	61
➤ Medium G Eur. Pharm. 5th Ed.	79
➤ Medium G	79
➤ Medium J	37
➤ Medium L Eur. Pharm. 5th Ed.	47
➤ Medium N Eur. Pharm. 5th Ed.	52
➤ Medium O Eur. Pharm. 5th Ed.	41
➤ Medium Of The Eur. Pharm. 5th Ed.	121
➤ Medium P Eur. Pharm. 5th Ed.	99
➤ Medium R Eur. Pharm. 5th Ed.	71
Methyl Red Voges Proskauer Broth (MRVP Broth)	82
Methyl Red Voges Proskauer Saline Broth	82
Microbial Content Test Agar	83
Microinstant® Listeria Selective Supplement	150
Mineral Modified Glutamate Agar Base	83
Mineral Modified Glutamate Medium Base	83
Mio Fluid Medium, see Motility Indol Ornithine Fluid Medium	84
MiStraCon® microbiologic strains for control	152
Mistracon®QuantyE-Pellets	154
Mistracon®QuantyPellets	155
Mistracon®Swabs2	153
➤ MKTTn	87
➤ mlST	118
Motility Indol Ornithine Fluid Medium (MIO)	84
Motility Indole Urea	84
Motility Nitrate Medium	84
MRD, see Maximum Recovery Diluent	82
MRS Agar	85
MRS Agar (ISO)	85
MRS Broth	85

DESCRIPTION	PAGE
MRS, Broth (Non porcine origin)	86
➤ MRVP Broth	82
MRVP Broth, see Methyl Red Voges Proskauer Broth	82
➤ MRVP Saline Broth	82
MRVP Saline Broth, see Methyl Red Voges Proskauer Saline Broth	82
MSRV, see Rappaport Vassiliadis Modified Semisolid Medium Base	98
Mueller-Hinton Agar	86
Mueller-Hinton Blood Agar	86
M	
Mueller-Hinton Broth	87
MUG Fluorescent Supplement	150
Müller-Kauffmann Tetrathionate Broth Base	87
MYP Agar, see Bacillus cereus Agar	40
N	
Nalidixic Acid Selective Supplement	150
➤ Neomycin Assay Agar	37
Neutralizing Broth (APHA)	87
Neutralizing Fluid	88
Neutralizing Special Broth	88
Nickerson Agar	88
➤ Nickerson Candida Selective Agar	88
Nitrate Broth	88
Novobiocin Selective Supplement	150
Nutrient Agar	89
Nutrient Agar (APHA, ISO)	89
Nutrient Agar (ISO)	89
Nutrient Broth (APHA)	89
Nutrient Broth (B.Ph.)	90
Nutritive No.1 Broth	90
O	
➤ O/F Basal Medium according to Hugh & Leifson	91
➤ O/F Enteric Medium	91
➤ O/F Medium see Oxidation-Fermentation Fluid Medium Base	91
➤ O/F Medium	91
OFBBL Agar, see Burkholderia cepacia Selective Agar Base	51

➤ This index contains synonymous names of products to facilitate your search. They are marked with a green arrow. In the catalogue they are next to the product name.

DESCRIPTION	PAGE
➤ OGY Agar	104
➤ OGYE Agar Base	104
OGYEA, see Sabouraud Oxytetracycline Agar	104
Orange Serum Agar	90
➤ OSA	90
Oxford Agar Base	90
Oxford Agar Selective Supplement	150
Oxidation-Fermentation Fluid Medium Base (O/F Medium)	91
Oxidation-Fermentation Glucose Medium	91
Oxytetracycline Selective Supplement	150
➤ Oxytetracycline-Glucose-Yeast Extract Agar	104
P	
➤ P Agar	69
➤ PA Medium	93
Palcam Agar Base	91
Palcam Agar Selective Supplement	150
➤ PCA Modified	94
PCA Modified, see Plate Count Modified Agar	94
PCA Skim Milk Agar, see Plate Count Skim Milk Agar	95
➤ PCA Skin Milk Agar	95
PCA, see Plate Count Agar	94
PDA, see Potato Dextrose Agar	95
PDB, see Potato Dextrose Broth	95
➤ PEMBA (Polymyxin-Egg yolk-Manitol-Blue-Agar)	41
PEMBA, see Bacillus cereus Selective Agar	40
➤ Penassay Seed Agar	37
➤ Penicillin Assay Speed Agar	37
➤ Peptone Polysorbate	63
➤ Peptone Eater for genetics	109
➤ Peptone Water	116
Peptone Water, Alkaline	92
Peptone Water, Alkaline Saline	92
➤ Peptone Water, Phosphate-Buffered, see Buffered Peptone Phosphate Water	48
Peptone Water, Saline, see Maximum Recovery Diluent	82
Peptone Water, Salt	92

DESCRIPTION	PAGE
Peptone Water, see Tryptone Water	116
➤ Perfringens Selective Agar	55
Phenol Red Broth Base	93
Phenylalanine Agar (PPA)	93
Phosphate Buffered Saline (PBS) pH 7,2	93
➤ Pigment Production Agar A	69
➤ Pigment Production Agar B	69
Plate Count Agar (PCA)	94
Plate Count Modified Agar	94
Plate Count Skim Milk Agar	95
Polymyxin B sulfate Selective Supplement	150
Polysorbate 80 (Polyoxyethylene Sorbitan Monooleate)	145
Potassium Tellurite Sterile Solution	145
Potato Dextrose Agar (Eur. Pharm.)	95
Potato Dextrose Broth	95
➤ PPA	93
Preston Campylobacter Agar Base	96
Preston Campylobacter Broth Base	96
Proteus mirabilis ATCC® 29906™/ WDCM 00023	153
➤ PS Medium A	69
➤ PS Medium B	69
Pseudomonas aeruginosa ATCC® 9027™/ WDCM 00026	153, 154, 155
Pseudomonas Agar Base (ISO)	96
➤ Pseudomonas Agar Medium for Detection of Fluorescein	69
➤ Pseudomonas Agar Medium for detection of Pyocyanin	69
Pseudomonas CFC Agar	96
➤ Pseudomonas Selective Agar Base	52
➤ Pseudomonas Selective Medium	52
➤ Pseudosel	52
➤ PSP	69
Purple Broth Base	97
R	
R2A Agar	97
Raka Ray Agar	97
RAMBACH™ Agar	141

➤ This index contains synonymous names of products to facilitate your search. They are marked with a green arrow. In the catalogue they are next to the product name.

DESCRIPTION	PAGE
R (CONTINUATION)	
RambaQUICK™ Salmonella	141
Rappaport Vassiliadis Broth	98
Rappaport Vassiliadis Modified SemiSolid Medium Base	98
➤ Rappaport Vassiliadis R10 Broth	98
Rappaport Vassiliadis Salmonella Enrichment Broth	98
➤ RBC Agar	100
RCA, see Reinforced Clostridial Agar	99
RCM, see Reinforced Clostridial Medium	99
Reagents for biochemical tests	156
Reagents for microbiological applications	156
Reagents for molecular biology	158
Reinforced Clostridial Agar	99
Reinforced Clostridial Medium (Eur. Pharm.)	99
Reinforced Clostridial Medium Differential (DRCM)	60
➤ Reinforced Medium for Clostridia	99
RF-TLHC	99
Rhamnose Broth	100
Ringer, powder	100
➤ Rose Bengal Agar	100
Rose Bengal Chloramphenicol Agar	100
➤ Rose Bengal Chloramphenicol Agar	100
➤ Rose Bengal-Malt Extract Agar	100
Rosolic Acid Solution 1%	145
RPF Supplement	150
➤ RVS Broth	98
S	
Sabouraud Broth (Eur. Pharm.)	101
Sabouraud Chloramphenicol Agar	101
Sabouraud Chloramphenicol Gentamicin Cycloheximide	102
Sabouraud Chloramphenicol Modified Agar	102
Sabouraud Chloramphenicol Penase Agar	102
Sabouraud Dextrose Agar	103
Sabouraud Oxytetracycline Agar (OGYEA)	104
Saccharomyces cerevisiae ATCC® 9763™/ WDCM 00058	153

DESCRIPTION	PAGE
Sakazakii Agar Chromogenic Microinstant®	130
➤ Saline Peptone Water	82
Saline Solution	104
Salmonella abony NCTC® 6017™	153
Salmonella enterica serovar typhimurium ATCC® 14028™/ WDCM 00031	153, 154, 155
Salmonella Shigella Agar (SS Agar)	104
SCA, see Sabouraud Chloramphenicol Agar	101
Schaedler Agar	105
Scholten's Agar (modified)	105
Scholten's Broth (modified)	105
SDA, see Sabouraud Dextrose Agar	103
➤ Seed Agar	37
Selective supplements	147
Selenite Broth Base	105
Selenite Cystine Broth Base	106
➤ Selenite F Broth	105
Shigella Broth	106
SIM Medium	106
Simmons Citrate Agar	106
Skimmed milk powder	145
Slanetz Bartley Agar	107
➤ Slanetz Enterococcus Agar	107
➤ SM Agar	94
➤ SMA	94
SMAC Agar, see MacConkey Sorbitol Agar	79
Sodium Disulfite (Sodium Meta-Bisulfite) for Bacteriology	150
Sorbitol Bile Broth	107
Sporulating Agar	107
SPS Agar, see Clostridium perfringens Selective Agar	55
SS Agar, see Salmonella Shigella Agar	104
➤ Standard Methods Agar	94
Staphylococcus aureus subsp. aureus ATCC® 6538™/ WDCM 00032	153, 154, 155
Staphylococcus epidermidis ATCC® 12228™/ WDCM 00036	153
Strains, MiStraCon® (microbiologic strains for control)	152
Stuart Ringertz Transport Medium	108

➤ This index contains synonymous names of products to facilitate your search. They are marked with a green arrow. In the catalogue they are next to the product name.

DESCRIPTION	PAGE
Sugar Free Agar	108
➤ Sulfite Polymyxin Sulfadiazine Agar	55
T	
➤ T7 Agar	53
➤ TAPLIN Agar	58
TBA, see Tryptone Bile Agar	115
TBX Agar, see Tryptone Bile Glucuronic Agar Microinstant®	130
TCBS Agar	108
➤ Tech Agar	69
➤ Tellurite-Glycine-Phenol Red Agar Base	122
➤ Tergitol® 7 Agar	53
TERGITOL® 7 Agar, see Chapman TTC Agar	53
Terrific Broth	109
➤ Tetrathionate according to Müller-Kauffmann Broth	87
Tetrathionate Bile Brilliant Green Broth Base	109
m-TGE	116
➤ TGE Agar	115
➤ TGE W: Lecithin w. Tween® 80	73
TGE, see Tryptone Glucose Extract Agar	115
➤ TGY Agar	94
Thayer Martin VCNT	109
Thioglycollate Broth	110
Thioglycollate Fluid Medium	110
Thioglycollate Fluid Medium Penase	110
Todd-Hewitt Broth	111
Tributylin Agar	111
Triple Sugar Iron Agar (TSI Agar)	111
➤ Trypticase Glucose Yeast Agar	94
Tryptic Soy Agar (TSA) (Eur. Pharm.)	112
Tryptic Soy Broth (TSB) (Eur. Pharm.)	114
Tryptic Soy Broth Modified	115
Tryptic Soy Broth without Dextrose	115
➤ Trypticase Glucose Extract Agar	115
Tryptone Bile Agar	115
Tryptone Bile Glucuronic Agar (TBX Agar) Microinstant®	130

DESCRIPTION	PAGE
➤ Tryptone Buffered Peptone	49
Tryptone Glucose Extract Agar (TGE Agar)	115
Tryptone Sulfite Neomycin Agar (TSN Agar)	116
Tryptone Water	116
Tryptone Yeast Extract Agar	117
Tryptophan Broth	117
Tryptose Lauryl Sulfate Broth	117
Tryptose Lauryl Sulfate Mannitol Tryptophan Broth	118
Tryptose Lauryl Sulfate Modified Base Broth (mLST)	118
Tryptose Sulfite Cycloserine Agar (TSC Agar)	119
➤ TSA Lecithin & Polysorbate	83
➤ TSA	112
➤ TSA with Lecithin and Tween®	83
TSA, see Tryptic Soy Agar	112
TSB Modified, see Tryptic Soy Broth Modified	115
➤ TSB	111, 114
TSB, see Tryptic Soy Broth	114
➤ TSBm	115
➤ TSC Agar	119
TSC, see Tryptose Sulfite Cycloserine Agar	119
➤ TSI Agar	111
TSI, see Triple Sugar Iron Agar	111
➤ TSN Agar	116
TSN, see Tryptone Sulfite Neomycin Agar	116
TTC (Tryphenil-tetrazolium chloride) 1%, sterile solution	145
TYEA, see Tryptone Yeast Extract Agar	117
U	
➤ UBA	120
Universal Beer Agar (UBA)	120
➤ Universal Diluent	82
Urea Agar Base	120
Urea Broth Base	120
Urea, sterile solution 40%	145
➤ USP Alternative Thioglycollate Medium	110
UVM (Listeria Enrichment Broth Base), see Listeria Enrichment Broth Base (UVM)	76

➤ This index contains synonymous names of products to facilitate your search. They are marked with a green arrow. In the catalogue they are next to the product name.

DESCRIPTION	PAGE
V	
Vancomycin Selective Supplement	150
Vaseline, Sterile	145
VCNT Selective Supplement	150
Violet Red Bile Dextrose Agar (VRBD Agar) (Eur. Pharm.)	121
Violet Red Bile Lactose Agar (VRBL Agar)	121
Violet Red Bile Lactose Dextrose Agar	121
➤ VJ Agar	122
Vogel Johnson Agar (VJ Agar)	122
➤ VRB Agar	121
VRBA, see Violet Red Bile Agar	121
➤ VRBD Agar	121
VRBD, see Violet Red Bile Dextrose Agar	121
➤ VRBG Agar	121
➤ VRBL	121
➤ VRBLD Agar	121
➤ VRBLDA Medium	121
W	
Water Peptone, Salt, see Peptone Water, Salt	92
➤ Water Plate Count Agar	117
WL Nutrient Agar	122
WL Nutrient Broth	122
Wort Agar	123
Wort Broth	123
X	
XLD Agar (Eur. Pharm.), see Xylose Lysine Deoxycholate Agar (Eur. Pharm.)	124
XLD Agar (ISO), see Xylose Lysine Deoxycholate Modified Agar	124
XL4 Agar Base	123
Xylose Fermentation Broth	123
Xylose Lysine Deoxycholate Agar (XLD Agar) (Eur. Pharm.)	124
Xylose Lysine Deoxycholate Modified Agar	124
Y	
➤ YDC Agar	53
➤ YEAST & MALT EXTRACT Agar	125
➤ YEAST & MALT EXTRACT Broth	125

DESCRIPTION	PAGE
Yeast Extract Peptone Dextrose Broth (YEPD Broth)	124
➤ Yeast Extract-Dextrose-Chloramphenicol Agar	53
➤ Yeast Extract-Glucose-Chloramphenicol Agar	53
Yeast Malt Agar (YM Agar)	125
Yeast Malt Broth	125
Yeast Starch Glucose Agar	125
Yeast Starch Glucose Broth (YSG)	126
➤ YEPD Broth	124
YEPD Broth, see Yeast Extract Peptone Dextrose Broth	124
Yersinia CIN Agar Base	126
➤ Yersinia Selective Agar	126
Yersinia Selective Supplement	150
➤ YGC Agar	53
YGC Broth, see Chloramphenicol Glucose Agar (CGA)	53
YM Agar, see Yeast Malt Agar	125
YM Broth, see Yeast Malt Broth	125
➤ YMA	125
➤ YSG Agar	125
YSG Agar, see Yeast Starch Glucose Agar	125
➤ YSG Broth	126
YSG Broth, see Yeast Starch Glucose Broth	126

➤ This index contains synonymous names of products to facilitate your search. They are marked with a green arrow. In the catalogue they are next to the product name.

ART. NO.	PAGE
000094217	48
0001000166	143
0001000167	143
0001000168	142
0001000169	142
0001000867	142
0001000868	142
0001000869	143
0001000870	143
0001000887	143
0001000888	143
0001000899	142
0001000900	143
0001001013	142
0001001014	143
0001002938	143
0001002941	142
0001002942	142
0001002944	142
0001002945	142
0001002947	143
0001002948	143
0001002950	143
0001002951	142
0001002952	143
0001002953	143
0001002960	142
0001002961	143
0001002970	143
0001002971	143
0001002973	143
00000X056	132
00000AC092	132
00000BC732	133
00000CA222	133
00000CA223	133
00000CD122	134
00000CGRT2	133
00000CP572	133
00000CP573	133
00000CQ382	139
00000CQ392	140
00000CS812	135
00000EB042	135
00000EC168	135
00000EC169	135
00000EE222	138
00000EE223	138
00000EF322	134
00000EF323	134
00000EF342	134
00000EL382	136
00000ESRT2	135
00000KPR2	136
00000LK970	136
00000LM852	136
00000MR502	137
00000MS252	137
00000MZ282	137
00000PF652	134
00000PS832	138
00000RR702	141

ART. NO.	PAGE
00000RR703	141
00000RT412	138
00000RT413	138
00000SA132	138
00000SA133	138
00000SA162	139
00000SA163	139
00000SB282	140
00000SB283	140
00000SC172	137
00000SQ001	141
00000ST162	139
00000TA672	139
00000VB912	140
00000VR952	140
00000VR953	140
00000YE492	141
0000TN1519	156
00BA1012-6	114
00CL0004-1	158
00SU703-25	139
01-001-500	69
01-001BA05	69
01-007-500	36
01-009-500	37
01-009BA05	37
01-014-500	39
01-016-500	37
01-017-500	37
01-017BA05	37
01-026-500	39
01-029-500	69
01-029BA05	69
01-030-500	41
01-030BA05	41
01-034-500	45
01-034BA05	45
01-047-500	54
01-047BA05	54
01-050-500	55
01-050BA05	55
01-051-500	56
01-053-500	53
01-053BA05	53
01-057-500	58
01-057BA05	58
01-068-500	61
01-068BA05	61
01-069-500	107
01-082-500	115
01-083-500	93
01-083BA05	93
01-094-500	78
01-094BA05	78
01-103-500	70
01-103BA05	70
01-111-500	80
01-111BA05	80
01-116-500	53
01-116BA05	53
01-118-500	78
01-118BA05	78

ART. NO.	PAGE
01-132-500	123
01-135-500	85
01-135BA05	85
01-136-500	86
01-136BA05	86
01-137-500	88
01-137BA05	88
01-140-500	89
01-140BA05	89
01-144-500	89
01-144BA05	89
01-160-500	52
01-160BA05	52
01-161-500	94
01-161BA05	94
01-164-500	121
01-164BA05	121
01-165-500	103
01-165BA05	103
01-166-500	101
01-166BA05	101
01-177-500	106
01-177BA05	106
01-192-500	111
01-192BA05	111
01-195-500	116
01-195BA05	116
01-200-500	112
01-200BA05	112
01-203-500	47
01-203BA05	47
01-206-500	122
01-206BA05	122
01-210-500	122
01-211-500	124
01-211BA05	124
01-216-500	67
01-216BA05	67
01-219-500	125
01-220-500	121
01-231-500	105
01-236-500	73
01-237-500	74
01-237BA05	74
01-245-500	78
01-261-500	120
01-261BA05	120
01-262-500	40
01-262BA05	40
01-263-500	68
01-264-500	108
01-265-500	44
01-265BA05	44
01-275-500	104
01-275BA05	104
01-278-500	119
01-278BA05	119
01-287-500	62
01-289-500	99
01-291-500	81
01-294-500	69
01-295-500	121

ART. NO.	PAGE
01-295BA05	121
01-298-500	67
01-301-500	100
01-301BA05	100
01-309-500	47
01-309BA05	47
01-310-500	64
01-323-500	77
01-329-500	94
01-329BA05	94
01-346-500	59
01-346BA05	59
01-352-500	44
01-352BA05	44
01-366-500	53
01-366BA05	53
01-385-500	72
01-385BA05	72
01-412-500	95
01-412BA05	95
01-430-500	38
01-434-500	38
01-442-500	58
01-444-500	126
01-446-500	75
01-451-500	96
01-470-500	91
01-470BA05	91
01-471-500	90
01-471BA05	90
01-483-500	95
01-483BA05	95
01-485-500	59
01-487-500	41
01-487BA05	41
01-502-500	65
01-502BA05	65
01-505-500	45
01-505BA05	45
01-513-500	56
01-513BA05	56
01-524-500	71
01-526-500	115
01-526BA05	115
01-540-500	97
01-540BA05	97
01-552-500	124
01-552BA05	124
01-555-500	104
01-555BA05	104
01-556-500	58
01-566-500	57
01-567-500	108
01-567BA05	108
01-573-500	80
01-573BA05	80
01-574-500	80
01-579-500	107
01-579BA05	107
01-589-500	60
01-589BA05	60
01-590-500	117

ART. NO.	PAGE
01-590BA05	117
01-592-500	44
01-592BA05	44
01-599-500	46
01-599BA05	46
01-609-500	55
01-609BA05	55
01-613-500	83
01-613BA05	83
01-618-500	129
01-618BA05	129
01-619-500	130
01-619BA05	130
01-633-500	66
01-634-500	67
01-634BA05	67
01-635-500	89
01-635BA05	89
01-657-500	59
01-657BA05	59
01-659-500	83
01-659BA05	83
01-660-500	60
01-664-500	54
01-664BA05	54
01-672-500	79
01-673-500	125
01-673BA05	125
01-674-500	68
01-674BA05	68
01-675-500	42
01-675BA05	42
01-680-500	55
01-680BA05	55
01-682-500	79
01-685-500	52
01-687-500	42, 43, 73
01-687BA05	42, 43, 73
01-689-500	45
01-692-500	65
01-695-500	128
01-695BA05	128
01-698-500	90
01-703-500	56
01-706-500	66
01-708-500	123
01-719-500	130
01-719BA05	130
01-728-500	96
01-729-500	79
01-729BA05	79
01-736-500	51
01-736BA05	51
01-739-500	51
01-743-500	39
01-744-500	130
01-744BA05	130
01-781-500	120
01-797-500	128
01-797BA05	128
01-801-500	97
01-802-500	57

ART. NO.	PAGE
01-803-500	85
01-816-500	46
01-828-500	129
01-840-500	105
01-862-500	62
02-007-500	37
02-011-500	38
02-027-500	40
02-028-500	40
02-032-500	93
02-041-500	47
02-041BA05	47
02-060-500	60
02-060BA05	60
02-064-500	61
02-064BA05	61
02-093-500	66
02-093BA05	66
02-105-500	70
02-105BA05	70
02-108-500	117
02-108BA05	117
02-111-500	80
02-118-500	78
02-118BA05	78
02-132-500	123
02-135-500	85
02-135BA05	85
02-135H500	86
02-136-500	87
02-136BA05	87
02-138-500	88
02-140-500	90
02-140BA05	90
02-144-500	89
02-144BA05	89
02-165-500	101
02-165BA05	101
02-186-500	110
02-186BA05	110
02-191-500	111
02-200-500	114
02-200BA05	114
02-202-500	120
02-202BA05	120
02-207-500	82
02-207BA05	82
02-219-500	125
02-227-500	115
02-227BA05	115
02-230-500	65
02-230BA05	65
02-236-500	74
02-236BA05	74
02-237-500	74
02-237BA05	74
02-257-500	43
02-257BA05	43
02-263-500	68
02-271-500	39
02-271BA05	39
02-277-500	49

ART. NO.	PAGE
02-277BA05	49
02-335-500	87
02-335BA05	87
02-336-500	57
02-379-500	98
02-379BA05	98
02-384-500	72
02-385-500	73
02-385BA05	73
02-406-500	72
02-410-500	99
02-418-500	117
02-456-500	82
02-460-500	118
02-472-500	76
02-472BA05	76
02-473-500	124
02-474-500	109
02-483-500	95
02-483BA05	95
02-491-500	81
02-494-500	50
02-494BA05	50
02-496-500	76
02-496BA05	76
02-497-500	92
02-498-500	75
02-498BA05	75
02-501-500	90
02-510-500	82
02-510BA05	82
02-512-500	88
02-512BA05	88
02-519-500	71
02-539-500	52
02-539BA05	52
02-561-500	96
02-568-500	48
02-575-500	114
02-583-500	88
02-598-500	105
02-598BA05	105
02-599-500	46
02-599BA05	46
02-602-500	106
02-602BA05	106
02-611-500	79
02-611BA05	79
02-627-500	77
02-629-500	109
02-629BA05	109
02-633-500	66
02-633BA05	66
02-651-500	36
02-656-500	83
02-656BA05	83
02-662-500	106
02-662BA05	106
02-663-500	97
02-668-500	98
02-668BA05	98
02-673-500	126

ART. NO.	PAGE
02-675-500	42
02-675BA05	42
02-688-500	45
02-691-500	115
02-697-500	92
02-711-500	118
02-725-500	114
02-745-500	75
02-802-500	57
02-827-500	56
02-840-500	105
02-862-500	62
03-037-500	91
03-156-500	116
03-156BA05	116
03-176-500	106
03-176BA05	106
03-187-500	110
03-187BA05	110
03-289-500	99
03-289BA05	99
03-376-500	98
03-376BA05	98
03-422-500	84
03-428-500	36
03-428BA05	36
03-454-500	108
03-612-500	84
03-612BA05	84
03-632-500	71
03-643-500	51
03-643BA05	51
06-011-100	122, 145
06-016-100	40, 41, 119, 144
06-017LY01	87
06-017LY01	148
06-019-005	145
06-019-500	145, 146
06-021LY01	40, 41, 150
06-022LY01	122
06-022LY01	148
06-023-100	53, 69, 107, 145
06-026-100	41, 144
06-073-500	100
06-077-100	91, 145
06-083-100	120, 145
06-089-100	65, 122, 145
06-102LY01	121, 150
06-106LY01	76, 150
06-107LY01	75, 150
06-110LY01	91, 150
06-111LY01	76, 150
06-112LY01	76, 148
06-113LY01	71, 148
06-114LY01	71, 150
06-115LY01	103, 104, 150
06-116LY01	119, 148
06-118LY01	103, 148
06-120-050	158
06-124LY01	55, 150
06-125LY01	56, 148
06-126LY01	44, 45, 148

ART. NO.	PAGE
06-127LY01	90, 150
06-130LY01	96
06-131LY01	45, 148
06-133LY01	52, 148
06-134LY01	43, 148
06-135LY01	96
06-136LY01	76, 150
06-137LY01	42, 73, 148
06-138LY01	73, 148
06-139LY01	98, 115, 150
06-140LY01	128, 129, 148
06-141LY01	64
06-142LY01	64, 150
06-143LY01	126, 150
06-144LY01	64, 148
06-145LY01	76, 150
06-146LY01	79, 148
06-155LY01	66
06-712LY01	56, 118, 150
06-726LY01	96, 148
06-737LY01	51
06-737LY01	148
06-741LY01	51
06-741LY01	148
06-742LY01	96, 148
06-743LY01	119
06-744LY01	119
06-754-024	130
06-755LY01	130, 150
06-756-006	147
06-790LY01	76, 150
06-794LY01	119
064-BA0001	63
064-BA0002	114
064-BA0003	50
064-BA0004	114
064-BA0008	44
064-BA0013	117
064-BA0027	55
064-BA0072	97
064-BA01-2	49
064-BA01-3	49
064-BA01-5	49
064-BA0100	101
064-BA0103	93
064-BA02-2	76
064-BA02-3	76
064-BA02-5	76
064-BA03-3	114
064-BA03-5	114
064-BA04-3	82
064-BA04-5	82
064-BA0485	121
064-BA0486	49
064-BA0582	85
064-BA0733	82
064-BA0945	130
064-BA1003	78
064-BA1004	86
064-BA1005	94
064-BA1006	103
064-BA1007	101

ART. NO.	PAGE
064-BA1008	112
064-BA1009	100
064-BA1011	121
064-BA1012	114
064-BA1018	41, 144
064-BA1020	106
064-BA1022	43
064-BA1023	116
064-BA1024	87
064-BA1026	110
064-BA1028	41
064-BA1029	110
064-BA1032	52
064-BA1033	41
064-BA1035	89
064-BA1043	74
064-BA1191	77
064-BA1546	59
064-BA2022	43
064-BA2035	117
064-BA2120	95
064-BA2126	116
064-BA2128	104
064-BA2129	40
064-BA2130	85
064-BA2131	111
064-BA2132	114
064-BA2135	51
064-BA2136	37
064-BA2143	79
064-BA2144	61
064-BA3007	103
064-BA3018	74
064-BA3019	73
064-BA3021	50
064-BA3029	70
064-BA3034	100
064-BA3037	52
064-BA3038	94
064-BA3039	101
064-BA3043	50
064-BA3051	99
064-BA3057	95
064-BA3058	114
064-BA3059	110
064-BA3061	121
064-BA3063	95
064-BA3071	63
064-BA4006	114
064-BA4009	99
064-BA4010	49
064-BA5001	76
064-BA5002	76
064-BA5018	74
064-BA6000	49
064-BA6002	63
064-BA6006	63
064-BA6011	49
064-BA6012	49
064-BA6016	119
064-BA6041	121
064-BA6043	112

ART. NO.	PAGE
064-BA6062	50
064-BA6063	50
064-BA6064	50
064-BA6065	92
064-BA6073	61
064-BA6079	46
064-BA6080	98
064-BA7029	57
064-BA7036	80
064-BA7037	63
064-BA7038	41
064-BA7040	129
064-BA7042	70
064-BA7051	87
064-BA7052	63
064-BA7066	107
064-BA7067	93
064-BA7069	93
064-BA7070	93
064-BA7071	50
064-BA7080	67
064-BA7083	46
064-BA7161	90
064-BA7945	130
064-BA8001	74
064-BA8002	74
064-BA8003	78
064-BA8005	62, 145
064-BA8008	114
064-BA8009	114
064-BA8012	63
064-BA8013	63
064-BA8017	75
064-BA8019	100
064-BA8032	95
064-BA8038	78
064-BA8043	49
064-BA8047	63
064-BA8048	64
064-BA8051	48
064-BA8054	48
064-BA8055	45
064-BA8056	50
064-BA8057	50
064-BA8059	50
064-BA8063	59
064-BA8070	119
064-BA8073	48
064-BA8074	48
064-BA8076	110
064-BA8077	114
064-BA8078	50
064-BA8080	49
064-BA8081	48
064-BA8085	64
064-BA8093	53
064-BA8103	63
064-BA8112	94
064-BA8117	117
064-BA8132	103
064-BA8133	63
064-BA8233	62

ART. NO.	PAGE
064-BA8234	62
064-BA9992	53
064-CL0234	156
064-CT0001	66
064-CT0002	116
064-CT0005	122
064-FP0002	48
064-PA0001	54
064-PA0003	123
064-PA0004	45
064-PA0007	85
064-PA0008	41
064-PA0009	52
064-PA0010	54
064-PA0011	53
064-PA0012	58
064-PA0013	61
064-PA0014	67
064-PA0015	95
064-PA0017	73
064-PA0018	88
064-PA0019	78
064-PA0020	86
064-PA0021	86
064-PA0022	103
064-PA0024	94
064-PA0025	103
064-PA0026	101
064-PA0027	80
064-PA0028	104
064-PA0029	108
064-PA0030	109
064-PA0031	112
064-PA0032	40
064-PA0034	124
064-PA0038	100
064-PA0045	47
064-PA0046	121
064-PA0047	74
064-PA0048	53
064-PA0049	121
064-PA0050	52
064-PA0053	56
064-PA0055	113
064-PA0059	89
064-PA0063	123
064-PA0064	59
064-PA0066	56
064-PA0069	42
064-PA0070	91
064-PA0073	55
064-PA0076	133
064-PA0077	138
064-PA0082	141
064-PA0083	139
064-PA0084	130
064-PA0100	112
064-PA0108	37
064-PA0134	113
064-PA0137	101
064-PA0138	112
064-PA0139	112

ART. NO.	PAGE
064-PA0144	94
064-PA0145	41
064-PA0146	130
064-PA0147	103
064-PA0172	97
064-PA0945	130
064-PA1035	124
064-PA1039	135
064-PA2117	64
064-PA3124	104
064-PA3125	107
064-PA3134	44
064-PA3135	102
064-PA3137	113
064-PA6001	43
064-PA6006	113
064-PA6044	96
064-PA6064	51
064-PA6065	128
064-PA6066	59
064-PA6068	59
064-PA6071	112
064-PA6074	113
064-PA6079	137
064-PA6082	113
064-PA608T	113
064-PA6090	43
064-PA6113	48
064-PA6115	105
064-PA6125	102
064-PA6139	116
064-PA6149	62
064-PA7035	90
064-PA9997	45
064-PF0001	89
064-PF0002	55
064-PF0003	53
064-PF0004	107
064-PF0005	55
064-PF0006	103
064-PF0007	94
064-PF0008	44
064-PF0013	117
064-PF0014	115
064-PF0018	119
064-PF0022	101
064-PF0024	62
064-PF0025	53
064-PF0026	112
064-PF0030	56
064-PF0063	123
064-PF0072	97
064-PF0701	69
064-PF1015	128
064-PF6019	122
064-PF6021	128
064-PF6024	119
064-PF6025	138
064-PF6029	95
064-PF6030	41
064-PF9999	61
064-PLA-CO	156

ART. NO.	PAGE
064-PR0001	94
064-PR0002	103
064-PR0003	101
064-PR0004	112
064-PR0005	112
064-PR0006	121
064-PR0007	100
064-PR0008	41
064-PR0009	52
064-PR0011	78
064-PR0012	67
064-PR0013	112
064-PR0015	53
064-PR0018	121
064-PR0020	94
064-PR0022	103
064-PR0027	113
064-PR0028	113
064-PR0031	80
064-PR0035	102
064-PR0037	101
064-PR0038	112
064-PR0039	94
064-PR0040	113
064-PR0041	94
064-PR0042	103
064-PR0044	121
064-PR0050	113
064-PR0061	113
064-PR0062	103
064-PR0092	58
064-TA0013	117
064-TA0094	104
064-TA0095	104
064-TA0100	49
064-TA0102	44
064-TA0103	93
064-TA0104	93
064-TA0105	104
064-TA0106	106
064-TA0110	55
064-TA0112	93
064-TA0113	114
064-TA0114	157
064-TA0115	117
064-TA0116	70
064-TA0117	78
064-TA0119	84
064-TA0120	116
064-TA0121	112
064-TA0128	88
064-TA0129	91
064-TA0131	158
064-TA0132	157
064-TA0134	110
064-TA0135	103
064-TA0136	101
064-TA0137	110
064-TA0138	105
064-TA0143	46
064-TA0144	120
064-TA0147	121

ART. NO.	PAGE
064-TA0148	120
064-TA0151	47
064-TA0152	47
064-TA0153	157
064-TA0155	41, 150
064-TA0157	111
064-TA0158	40
064-TA0159	81
064-TA0163	106
064-TA0165	77
064-TA0166	77
064-TA0173	85
064-TA0177	111
064-TA0179	47
064-TA0189	61
064-TA0190	65
064-TA0191	65
064-TA0193	61
064-TA0194	104
064-TA0196	118
064-TA0197	68
064-TA0198	98
064-TA0201	99
064-TA0203	157
064-TA0221	112
064-TA0261	82
064-TA0325	94
064-TA0451	117
064-TA0452	118
064-TA0485	121
064-TA0846	71
064-TA0847	116
064-TA1024	87
064-TA1125	76
064-TA1198	98
064-TA1260	72
064-TA2022	43
064-TA2115	55
064-TA2120	100
064-TA2135	79
064-TA2141	70
064-TA2142	70
064-TA2144	89
064-TA2146	100
064-TA2147	114
064-TA2148	101
064-TA2151	50
064-TA2155	116
064-TA2156	116
064-TA2159	100
064-TA2160	101
064-TA2161	55
064-TA2170	84
064-TA5002	76
064-TA6017	104
064-TA6070	74
064-TA6074	82
064-TA6100	74
064-TA8283	74
064-TA8288	65
064-TA8300	85
064-TA8301	103

ART. NO.	PAGE
064-TA8302	125
064-TA8311	83
064-TA8312	83
064-TA8313	38
064-TA8314	38
064-TA8315	100
064-TA8316	123
064-TA8317	38
064-TA8327	91
064-TA8366	62
064-V00099	50
064-V00100	57
064-V11108	87, 144
064-V11111	144
064CL00021	156
064CL00061	156
064CL00081	156
064CL00101	157
064CL00111	158
064CL00121	157
064PA0024I	94
064PA0025I	103
064PA0026I	101
064PA0031I	112
064PA0072I	97
064PA0075I	112
064PF0030C	56
064PF0089P	66
064PF6017P	107
064PRB0013	112
064PRB0038	112
064PRB0040	113
064PRB0041	103
064PRB0042	101
064PRB0043	94
064PRB0044	94
064PRB0045	113
064PRB0091	100
064PRB0092	103
064PRB0093	121
064PRB0094	101
064PRB0095	113
064TA0125L	57
064TA2155E	60
07-004-500	146
07-039-500	146
07-075-500	146
07-079-500	146
07-080-500	146
07-119-500	146
07-151-500	146
07-152-500	146
07-153-500	146
07-154-500	146
07-155-500	146
07-197-500	146
07-342-500	146
07-455-500	146
07-489-500	146
07-515-500	146
07-525-500	146
07-6140025	146

ART. NO.	PAGE
07-620-500	146
07-625-500	146
07-636-500	146
07-716-500	146
0B21408-14	158
0BA1012-90	114
0BA1018-50	144
0BA1019-50	144
0BA1026-40	110
0BA2145-90	74
0BA3024-90	70
0BA3029-90	70
0BA3929-90	70
0TA2151-10	50
16028-0250	144
230-070491	157
64PRO004AL	112
64PRO005AL	112
64PRO013AL	112
64PRO022AL	103
64PRO037AL	101
64PRO038AL	112
64PRO042AL	103
AC00310100	146
AC0402	159
AC0406	159
AC0580	160
AC07441000	146
AC07461000	146, 157
AC0965	160
AC0967	160
AC19900010	146
AC3345	159
AG0030	159
AG0031	159
AG0032	159
AG0034	159
AG0036	159
AM0271	159
AM02730500	83, 146
AM0274	159
AM0371	159
AM0401	159
AM0468	158
AR01250050	146
AS00150025	146
BA1007-500	101
BA1008-500	112
BA9992-200	104
BI0090	159
BI0091	159
CA0198	160
CE0121	159
CI01450500	146
CI0155	160
CI03050025	146
CI0025	158
DI1360	160
EP2001-MSC	154
EP2002-MSC	154
EP2003-MSC	154
EP2004-MSC	154

ART. NO.	PAGE
EP2005-MSC	154
EP2006-MSC	154
EP2008-MSC	154
EP2010-MSC	154
EP2012-MSC	154
ET00021000	146
ET0011	160
ET00131000	146
ET0108	159
ET0109	159
FE0484	159
F00011	160
F00012	160
F00026	159
F00027	159
FU00600025	146
FU00600100	60
GE00200250	146
GL00261000	52, 69, 84, 146
GL0028	160
GL01250500	146
GU0061	159
GU0065	159
HE0011	158
HE0100	158
HI01351000	146, 156
HI04050025	146
IPO010	159
IS01400025	146
KA0010	158
LA00600500	146
LE00550025	146
LE00700500	146
LI00351000	146
LI0112	159
MA0037	160
MA0086	160
MA01000500	146
MA01500500	146
MA01600010	146
ME0095	160
MO0070	158
OR00550025	146
P10001-MSC	155
P10002-MSC	155
P10003-MSC	155
P10004-MSC	155
P10005-MSC	155
P10006-MSC	155
P10010-MSC	155
P10011-MSC	155
PI0061	158
PO0066	160
PO0080	160
PO0112	160
PO0201	160
PO0262	160
PO04100250	144, 146
RE00071000	157
RE0007G100	157
RE00500250	157
RE00571000	157

ART. NO.	PAGE
RE0057G100	157
RE0060G100	158
RE00650005	158
RE0100G100	158
S00001-MSC	153
S00002-MSC	153
S00003-MSC	153
S00004-MSC	153
S00005-MSC	153
S00006-MSC	153
S00007-MSC	153
S00008-MSC	153
S00009-MSC	153
S00010-MSC	153
S00011-MSC	153
S00012-MSC	153
S00014-MSC	153
S00015-MSC	153
S00016-MSC	153
S00017-MSC	153
S00018-MSC	153
S00019-MSC	153
S00020-MSC	153
S00021-MSC	153
S00022-MSC	153
S00023-MSC	153
S00024-MSC	153
S00025-MSC	153
S00026-MSC	153
S00027-MSC	153
SA0020	159
SA00200500	146
SA02000025	146
SD0010	159
S00036	160
SO01600100	105, 106, 145
SO0205	160
SO0230	160
SO02570100	146
SO02570500	146
SO0328	160
SO0329	160
SO04000500	83, 146
SO05900100	146
SO05900500	146
SO08500250	146
SO10040250	146
SO10070250	146
SU0030	159
TA0010	158, 159
TB0010	158, 159
TE0050	159
TI03250100	146
TR00300005	146
TR04000025	146
TR0422	158
TR0424	158
TR0425	158
TR04441000	146
TW0022	160
TW00220100	52
TW00800100	43, 57, 73, 74, 88, 145

ART. NO.	PAGE
UR0133	159
VA00550025	146
VI00250025	156
VI0027G100	156
XI00800100	146
Y000210100	144

DESCRIPTION	PAGE
A	
Absorbent and protective paper (reams)	223
Absorbents against unexpected spillages	235
Absorbents for laboratory	235
Additives for culture media	144
Air condenser	182
Allihn condenser	181
Aluminium blocks	187
Aluminium heating blocks	207
Anaerobic jar	210
Anaerobiosis	210
Atmosphere generator sachets	210
B	
Bags for homogenisation, sterile	234
Beakers	180
Bottles, laboratory	191
Burettes, glass	198
C	
Cellulose extraction thimbles	222
Centrifuge tubes	238
Chemical products for microbiology	146
Chemispill®, absorbents against unexpected spillages	235
Chromogenic media CHROMagar™	132
Chromogenic media Compact Dry®	142
Chromogenic media Microinstant®	128
Components for Premium compact minireactor vessels	207
Condensers	181
Containers, plastic	211
Crucibles, filter (glass)	195
Cylinders, graduated	202
Cylindrical flasks (Duchess type)	211
D	
Dehydrated and prepared culture media	36
Dimroth condensers	183
Dishes, plastic	233

DESCRIPTION	PAGE
Dispensation	212
Dispensers	212
Disposable gloves	236
Duchess plastic flasks	211
Durham (bell) tube	197
E	
Erlenmeyer flasks	185
Evaporating flasks	188
F	
Filter crucibles	195
Filter papers	213
Filter tips	232
Filters, syringe	225
Filtration	184, 213
Filtration assembly for 47 mm membranes	184
Filtration membranes	225
Filtration systems	184
Flasks, Erlenmeyer	185
Flasks, glass	185
Flasks, heart-shaped	188
Flasks, pear-shaped	188
Flasks, plastic	211
Flasks, spherical	186
Flasks, volumetric	199
Funnels	189
G	
Gay-Lussac glass pycnometers	193
Glass burettes	198
Glass extraction thimbles	223
Glass microfibre filters	221
Glass Pasteur pipettes	192
Glass reaction vessels	207
Glass soda test tube	196
Glass stoppers	192
Glassware for inert atmosphere	190

DESCRIPTION	PAGE
Gloves, disposable	236
Graduated cylinders	202
Graduated pipettes	201
Graduated plastic Pasteur pipettes	229
Ground joint glassware	173
H	
Heart-shaped flasks	188
Heating blocks	187, 207
Homogenisation, bags	234
I	
Indicator papers	228
Inert atmosphere, glassware for	190
Ingredients for microbiology	146
Inoculation loop	233
L	
Laboratory bottles	191
Liebig West condensers	183
Loops, inoculation	233
M	
Membranes	224
Membranes, filtration	225
Membranes, mobile phase filtration	224
Microfibre filter, glass	221
Microfibre filter, quartz	222
Minireactors	204
MiStraCon® - bacterial strains	152
P	
Paper, absorbent and protective (reams)	223
Papers, pH indicator	228
Pasteur pipettes, glass	192
Pasteur pipettes, plastic	229
Pear-shaped flasks	188
Petri dishes, plastic	233
Petri dishes, soda glass	192
pH indicator paper on a roll	228

DESCRIPTION	PAGE
pH indicator strips	228
Pipetes, graduated	201
Pipette filter tips	232
Pipette Pasteur, glass	192
Pipette Pasteur, plastic	229
Pipette tips for automatic pipettes	229
Pipettes	201, 229
Pipettes, volumetric	201
Plastic containers	211
Plastic flasks	211
Plastic Pasteur pipettes	229
Plastic, Petri dishes	233
Plastic, pipette tips	229
Plates	233
Premium minireactor	206
Pycnometers	193
Q	
Qualitative filter papers	219
Qualitative low ash filter papers	217
Quantitative filter papers	213
Quartz microfibre extraction thimbles	223
Quartz microfibre filters	222
R	
Racks, filters tips	231
Reaction vessels	207
Reagent bottle	191
Reagents for biochemical tests	156
Reagents for microbiological applications	156
Reagents for molecular biology	158
Reams	223
Receiving flasks	188
Renault glass pycnometers	193
S	
Sachets, atmosphere generator	210
Safety	235

DESCRIPTION	PAGE
S (CONTINUATION)	
Sample plastic containers	211
Schlenk filters	190
Schlenk flasks	190
Schlenk tubes	190
Selective supplements	147
Semi-quantitative test strips	228
Separating funnels	189
Soda glass Petri dishes	192
Soxhlet extractors	194
Soxhlet thimbles	222
Spherical flasks	186
Sterile bags for homogenisation	234
Sterile containers	211
Sterile disposable inoculating loops	233
Sterile membranes	225
Stoppers, glass	192
Stoppers, PE	192
Strips, pH indicator	228
Syringe filters	225
T	
Test tubes	196
Thimbles, extraction	222
Threaded containers for samples	211
Timers	237
Tips for automatic pipette	229
Tips in rechargeable racks	231
Tubes	196, 238
Tubes for centrifuge	238
Tubes, test	196
U	
Universal tips for automatic pipettes	229
V	
Volumetric flasks	199
Volumetric glassware	198

DESCRIPTION	PAGE
Volumetric pipettes	201
W	
Watch glasses	203
Weighing bottles	203
Weighing elements	203
Weighing funnels	203

ART. NO.	PAGE
0033768104	184
0381182040	203
0381182050	203
0381182060	203
0381182070	203
0381182080	203
0381182100	203
0381182120	203
0381182150	203
0381182200	203
0731024140	186
0731024144	186
1033510105	180
1033510106	180
1033510108	180
1033510110	180
1033510112	180
1033510113	180
1033510114	180
1033510115	180
1033510205	180
1033510206	180
1033510208	180
1033510210	180
1033510212	180
1033510213	180
1033510214	180
1033510215	180
1033527305	185
1033527307	185
1033527308	185
1033527309	185
1033527311	185
1033527314	185
1033527505	185
1033527507	185
1033527508	185
1033527509	185
1033527511	185
1033527514	185
1033550103	180
1033550104	180
1033550203	180
1033550204	180
1033567303	185
1033567304	185
1033567315	185
1033567503	185
1033567504	185
1033793101	189
1033793102	189
1033793104	189
1033793105	189
1033793106	189
1033793107	189
1033793108	189
1033793109	189
1033793110	189
1033793307	189
1033793308	189
1033793309	189
1033793310	189

ART. NO.	PAGE
2732163120	199
2733799005	191
2733799006	191
2733799007	191
2733799008	191
000P0210-1	229
000P0210-2	229
000P0520-2	230
000P1000-1	230
000P1000-2	230
000P5000-1	230
000P5000-2	230
000P5200-1	230
000P5200-2	230
000P5300-1	230
000P5300-2	230
000PF120-1	232
000PF120-2	232
00PC1000-1	230
00PC1000-2	230
00PC5200-1	230
00PC5200-2	230
00PF0110-1	232
00PF0110-2	232
00PF1100-1	232
00PF1100-2	232
00PF1200-1	232
00PF1200-2	232
00PMRPT100	207
027-801075	196
027-801275	196
027-813100	196
027-816100	196
027-816150	196
027-816160	196
027-818150	196
027-820150	196
027-820200	196
033-065.01	212
033-065.02	212
033-065.03	212
033-065.04	212
033-065.05	212
064-ag0p25	210
073-000025	188
073-000027	188
073-000042	194
073-000043	195
073-000053	188
073-000054	188
073-000055	188
073-000056	188
073-000057	188
073-000125	188
073-000126	188
073-000127	188
073-000128	188
073-000129	188
073-000313	189
073-000314	189
073-000315	189
073-000316	189

ART. NO.	PAGE
073-000317	189
073-000410	182
073-000411	182
073-000412	182
073-000416	182
073-000425	183
073-000426	183
073-000427	183
073-000428	183
073-000429	183
073-000430	183
073-000431	183
073-000432	183
073-000433	183
073-000446	181
073-000447	181
073-000449	181
073-000451	181
073-000473	183
073-000474	183
073-000475	183
073-000476	183
073-000477	183
073-000479	194
073-000480	195
073-000481	182
073-000729	194
073-000730	194
073-000731	195
073-000732	195
073-000733	195
073-000734	195
073-000735	195
073-000829	203
073-000830	203
073-000831	203
073-000832	203
073-000833	203
073-000834	203
073-000835	203
073-000836	203
073-000837	203
073-000838	203
073-000839	203
073-000840	203
073-000853	203
073-000854	203
073-000855	203
073-000986	193
073-000987	193
073-000988	193
073-000989	193
073-000990	193
073-000991	193
073-000992	193
073-000993	193
073-001119	184
073-001120	184
073-001121	184
073-001734	192
073-001735	192
073-008520	203

ART. NO.	PAGE
073-008531	203
073-0162/4	183
073-085550	203
073-100002	186
073-100003	186
073-100004	186
073-100005	186
073-100006	186
073-100007	186
073-100008	186
073-100009	186
073-100010	186
073-100012	186
073-100134	186
073-100135	186
073-100136	186
073-100137	186
073-100138	186
073-100139	186
073-100140	186
073-100142	186
073-100144	186
073-101043	192
073-101044	192
073-101045	192
073-101046	192
073-101047	192
073-101048	192
073-101049	192
073-101050	192
073-101064	192
073-101065	192
073-101066	192
073-101067	192
073-101068	192
073-101069	192
073-101075	192
073-101904	186
073-101905	186
073-101907	186
073-101909	186
073-102000	188
073-102405	186
073-102407	186
073-102409	186
073-102410	186
073-103000	188
073-107/16	192
073-10716P	192
073-113529	186
073-125005	188
073-125010	188
073-370113	190
073-370122	190
073-370128	190
073-370137	190
073-370149	190
073-370213	190
073-370222	190
073-370228	190
073-370237	190
073-370249	190

ART. NO.	PAGE
073-400481	182
073-426151	184
073-572000	188
073-Q279-5	184
073A100004	187
073A100005	187
073A100006	187
073A100007	187
073A100008	187
073A100009	187
073A100010	187
073QS03287	183
OARRASMINI	207
124-00620C	197
124-00630C	197
124-00640C	197
124-00730C	197
124-00740C	197
124-00830C	197
124-01075P	197
124-01275P	197
124-10100P	197
124-12100P	197
124-12120P	197
124-15150P	197
124-16100B	197
124-16160B	197
124-18180P	197
124-20200P	197
230-096118	210
230-096124	210
230-096125	210
230-096126	210
273-001520	198
273-001521	198
273-001522	198
273-001629	199
273-001630	199
273-001638	199
273-001748	202
273-001749	202
273-001755	202
273-001756	202
273-001757	202
273-201631	199
273-201632	199
273-201633	199
273-201634	199
273-201635	199
273-201636	199
273-201637	199
273-201638	199
273-201743	202
273-201744	202
273-201745	202
273-201746	202
273-201747	202
273-201750	202
273-201751	202
273-201752	202
273-201753	202
273-201754	202
273-991305	201

ART. NO.	PAGE
273-991676	201
273-991677	201
273-991678	201
273-991679	201
273-991681	201
273-991682	201
273-991683	201
273-991696	201
273-991697	201
273-991698	201
273-991699	201
273-991701	201
273-991702	201
273-991703	201
273-991715	201
273-991717	201
273-991719	201
273-991720	201
273-991721	201
273A001629	199
273A001630	199
273A001638	199
273A163120	199
273A201631	199
273A201632	199
273A201633	199
273A201634	199
273A201635	199
273A201636	199
273A201637	199
273D001630	200
273D201631	200
273D201632	200
273D201633	200
273D201634	200
273D201635	200
273D201636	200
273D201637	200
273D263120	200
273E001630	200
273E201631	200
273E201632	200
273E201633	200
273E201634	200
273E201635	200
273E201636	200
273E201637	200
273E263120	200
273N001630	200
273N201631	200
273N201632	200
273N201633	200
273N201634	200
273N201635	200
273N201636	200
273N201637	200
273N263120	200
273W001630	200
273W201631	200
273W201632	200
273W201633	200
273W201634	200

ART. NO.	PAGE
273W201635	200
273W201636	200
273W201637	200
273W263120	200
359-796001	192
359-796003	192
359-796006	192
359-796008	192
359-796009	192
359-796010	192
500-00MRJ3	208
500-00MRJ4	208
500-00MRS3	208
500-00MRS4	208
500-00MRT3	208
500-00MRT4	208
500-00PMR1	207
500-0MRJ25	208
500-0MRR50	207
500-0MRS25	208
500-0MRT25	208
500-0PHMER	207
500-MRR100	207
500-MRR250	207
500-PMRA50	208
500MRR5003	207
500MRR5004	207
500MRRTD50	207
500PMRA100	208
500PMRA250	208
500PMRA500	208
500TUBTELE	207
502EL8845S	237
50GTUBTELE	207
50MRR10004	207
50MRR20004	207
50PMRA1000	208
50PMRA2000	208
50PMRA5004	208
50PMRCAL50	207
50PMRMOT52	207
50PMRMOT53	207
5MRRTD1000	207
5MRRTD2000	207
5MRRTD5003	207
5MRRTD5004	207
5PMRCAL100	207
5PMRCAL250	207
5PMRCAL500	207
AB0001005P	235
AB00012000	235
AB00020400	235
AB00021000	235
AB00024000	235
AB0003005P	235
AB00032000	235
AB0004-KIT	235
AB0005ESTA	235
BAG0400-01	234
BAG0400-02	234
BAG0400-03	234
BRMRRTD100	207

ART. NO.	PAGE
BRMRRTD250	207
CAL-000010	187
CAL-000025	187
CAL-000050	187
CAL-000100	187
CAL-000250	187
CAL-000500	187
CAL-001000	187
CEA1320200	227
CEA1345200	227
CEA2520200	227
CEA2545200	227
CEP2520200	227
CEP2545200	227
CF2LAF0125	217
CF2LAF0150	217
CF2LAF0185	217
CF2LAF0240	217
CF2LAF0320	217
CF2LAG0090	217
CF2LAG0110	217
CF2LAG0125	217
CF2LAG0150	217
CF2LAG0185	217
CF2LAG0240	217
CF2LAG0320	217
CF2LAM0090	218
CF2LAM0110	218
CF2LAM0125	218
CF2LAM0150	218
CF2LAM0185	218
CF2LAM0240	218
CF2LAM0320	218
CF2LAP0090	218
CF2LAP0110	218
CF2LAP0125	218
CF2LAP0150	218
CF2LAP0185	218
CF2LAP0240	218
CF2LAP0320	218
CF2LAS0090	218
CF2LAS0110	218
CF2LAS0125	218
CF2LAS0150	218
CF2LAS0185	218
CF2LAS0240	218
CF2LAS0320	218
CF2STAE090	219
CF2STAE110	219
CF2STAE130	219
CF2STAE150	219
CF2STAE185	219
CF2STAE200	219
CF2STAE250	219
CF2STAE300	219
CF2STAF090	220
CF2STAF110	220
CF2STAF125	220
CF2STAF150	220
CF2STAF185	220
CF2STAF240	220
CF2STAF320	220

ART. NO.	PAGE
CF2STAM090	220
CF2STAM110	220
CF2STAM125	220
CF2STAM150	220
CF2STAM185	220
CF2STAM240	220
CF2STAM320	220
CF2STAR090	219
CF2STAR110	219
CF2STAR125	219
CF2STAR150	219
CF2STAR185	219
CF2STAR240	219
CF2STAR270	219
CF2STAR320	219
CF2WAE0110	215
CF2WAE0125	215
CF2WAE0150	215
CF2WAE0185	215
CF2WAE0240	215
CF2WAE0270	215
CF2WAF0110	215
CF2WAF0125	215
CF2WAF0150	215
CF2WAF0185	215
CF2WAF0240	215
CF2WAF0270	215
CF2WAFH110	214
CF2WAFH125	214
CF2WAFH150	214
CF2WAFH185	214
CF2WAFH240	214
CF2WAFH270	214
CF2WAG0110	215
CF2WAG0125	215
CF2WAG0150	215
CF2WAG0185	215
CF2WAG0240	215
CF2WAG0270	215
CF2WAG0320	215
CF2WAM0110	216
CF2WAM0125	216
CF2WAM0150	216
CF2WAM0185	216
CF2WAM0240	216
CF2WAM0270	216
CF2WAM0320	216
CF2WAMH110	214
CF2WAMH125	214
CF2WAMH150	214
CF2WAMH185	214
CF2WAMH240	214
CF2WAMH270	214
CF2WAP0110	216
CF2WAP0125	216
CF2WAP0150	216
CF2WAP0185	216
CF2WAP0240	216
CF2WAP0270	216
CF2WAP0320	216
CF2WAP0320	217
CF2WAS0110	216

ART. NO.	PAGE
CF2WAS0125	216
CF2WAS0150	216
CF2WAS0185	216
CF2WAS0240	216
CF2WAS0270	216
CF2WAS0320	216
CF2WASH110	214
CF2WASH125	214
CF2WASH150	214
CF2WASH185	214
CF2WASH240	214
CF2WASH270	214
CF2WAT0110	217
CF2WAT0125	217
CF2WAT0150	217
CF2WAT0185	217
CF2WAT0240	217
CF2WAT0270	217
CFILAF0047	217
CFILAF0055	217
CFILAF0070	217
CFILAF0090	217
CFILAF0110	217
CFILAF0125	217
CFILAF0150	217
CFILAF0185	217
CFILAF0240	217
CFILAG0047	217
CFILAG0055	217
CFILAG0070	217
CFILAG0090	217
CFILAG0110	217
CFILAG0125	217
CFILAG0150	217
CFILAG0185	217
CFILAG0240	217
CFILAG0320	217
CFILAM0047	218
CFILAM0050	218
CFILAM0055	218
CFILAM0070	218
CFILAM0090	218
CFILAM0110	218
CFILAM0125	218
CFILAM0150	218
CFILAM0185	218
CFILAM0240	218
CFILAP0047	218
CFILAP0050	218
CFILAP0055	218
CFILAP0070	218
CFILAP0090	218
CFILAP0110	218
CFILAP0125	218
CFILAP0150	218
CFILAP0185	218
CFILAP0240	218
CFILAP0320	218
CFILAS0047	218
CFILAS0050	218
CFILAS0055	218
CFILAS0070	218

ART. NO.	PAGE
CFILAS0090	218
CFILAS0110	218
CFILAS0125	218
CFILAS0150	218
CFILAS0185	218
CFILAS0240	218
CFILAT0047	219
CFILAT0050	219
CFILAT0055	219
CFILAT0070	219
CFILAT0090	219
CFILAT0110	219
CFILAT0125	219
CFILAT0150	219
CFILAT0185	219
CFILAT0240	219
CFILAT0320	219
CFISTAE090	219
CFISTAE110	219
CFISTAE125	219
CFISTAE130	219
CFISTAE150	219
CFISTAE200	219
CFISTAE250	219
CFISTAF090	220
CFISTAF110	220
CFISTAF125	220
CFISTAF150	220
CFISTAF185	220
CFISTAF240	220
CFISTAF320	220
CFISTAM090	220
CFISTAM110	220
CFISTAM125	220
CFISTAM130	220
CFISTAM150	220
CFISTAM185	220
CFISTAM240	220
CFISTAM320	220
CFISTAR090	219
CFISTAR110	219
CFISTAR125	219
CFISTAR130	219
CFISTAR150	219
CFISTAR185	219
CFISTAR240	219
CFISTAR270	219
CFISTAR320	219
CFISTAS125	220
CFISTAS185	220
CFISTAS240	220
CFISTAS320	220
CFIWAE0047	215
CFIWAE0050	215
CFIWAE0055	215
CFIWAE0070	215
CFIWAE0090	215
CFIWAE0110	215
CFIWAE0125	215
CFIWAE0150	215
CFIWAE0185	215
CFIWAE0240	215

ART. NO.	PAGE
CFIWAE0320	215
CFIWAF0047	215
CFIWAF0050	215
CFIWAF0055	215
CFIWAF0070	215
CFIWAF0090	215
CFIWAF0110	215
CFIWAF0125	215
CFIWAF0150	215
CFIWAF0185	215
CFIWAF0240	215
CFIWAFH047	214
CFIWAFH050	214
CFIWAFH055	214
CFIWAFH070	214
CFIWAFH090	214
CFIWAFH110	214
CFIWAFH125	214
CFIWAFH150	214
CFIWAFH185	214
CFIWAFH240	214
CFIWAG0047	215
CFIWAG0050	215
CFIWAG0055	215
CFIWAG0070	215
CFIWAG0090	215
CFIWAG0110	215
CFIWAG0125	215
CFIWAG0150	215
CFIWAG0185	215
CFIWAG0240	215
CFIWAG0320	215
CFIWAM0047	216
CFIWAM0050	216
CFIWAM0055	216
CFIWAM0070	216
CFIWAM0090	216
CFIWAM0110	216
CFIWAM0125	216
CFIWAM0150	216
CFIWAM0185	216
CFIWAM0240	216
CFIWAMH047	214
CFIWAMH050	214
CFIWAMH055	214
CFIWAMH070	214
CFIWAMH090	214
CFIWAMH110	214
CFIWAMH125	214
CFIWAMH150	214
CFIWAMH185	214
CFIWAMH240	214
CFIWAP0047	216
CFIWAP0050	216
CFIWAP0055	216
CFIWAP0070	216
CFIWAP0090	216
CFIWAP0110	216
CFIWAP0125	216
CFIWAP0150	216
CFIWAP0185	216
CFIWAP0240	216

ART. NO.	PAGE
CFIWAP0320	216
CFIWAS0047	216
CFIWAS0050	216
CFIWAS0055	216
CFIWAS0070	216
CFIWAS0090	216
CFIWAS0110	216
CFIWAS0125	216
CFIWAS0150	216
CFIWAS0185	216
CFIWAS0240	216
CFIWASH047	214
CFIWASH050	214
CFIWASH055	214
CFIWASH070	214
CFIWASH090	214
CFIWASH110	214
CFIWASH125	214
CFIWASH150	214
CFIWASH185	214
CFIWASH240	214
CFIWAT0047	217
CFIWAT0050	217
CFIWAT0055	217
CFIWAT0070	217
CFIWAT0090	217
CFIWAT0110	217
CFIWAT0125	217
CFIWAT0150	217
CFIWAT0185	217
CFIWAT0240	217
CFIWAT0320	217
CIAGPEEK14	208
CIAGPEEK29	208
CR13021000	226
CR13041000	226
CR25020200	226
CR25021000	226
CR25041000	226
CR25045200	226
CT32510X50	222
CT32519x90	222
CT32520X80	222
CT32522100	222
CT32525X60	222
CT32525X80	222
CT32526100	222
CT32526X60	222
CT32528100	222
CT32528120	222
CT32530100	222
CT32530X80	222
CT32530X95	222
CT32533100	222
CT32533118	222
CT32535120	222
CT32535150	222
CT32540150	222
CT32548145	222
DUQ0000060	211
DUQ0000100	211
DUQ0000125	211

ART. NO.	PAGE
DUQ0000250	211
DUQ0000500	211
DUQ0001000	211
DUQ0002000	211
EM47020100	224
EM47045100	224
EMC4720100	224
EMC4745100	224
ES47020100	225
ES4702010N	225
ES47045100	225
GLV-NSPOOL	236
GLV-NSP00M	236
GLV-NSP00S	236
GLV-NSPOXL	236
GLVBNSPOOL	236
GLVBNSP00M	236
GLVBNSP00S	236
GLVBNSPOXL	236
GMFA-50024	221
GMFA-50035	221
GMFA-50047	221
GMFA-50090	221
GMFA-50150	221
GMFB143024	221
GMFB143047	221
GMFB143090	221
GMFB143150	221
GMFC-52024	221
GMFC-52035	221
GMFC-52047	221
GMFC-52090	221
GMFC-52150	221
GMFD-12150	221
GMFD120024	221
GMFD120047	221
GMFD120090	221
GMFF-75024	221
GMFF-75037	221
GMFF-75047	221
GMFF-75090	221
GMFG-65037	221
GMFG-65047	221
MCE1320200	226
MCE1345200	226
MCE2520200	226
MCE2545200	226
MFQ-85T037	222
MFQ-85T047	222
MFQ-85T090	222
MFQ-85T150	222
MGT3210X50	223
MGT3216X50	223
MGT3222X80	223
MGT3225100	223
MGT3225X60	223
MGT3226X60	223
MGT3228100	223
MGT3228X60	223
MGT3230100	223
MGT3230X70	223
MGT3230X77	223

ART. NO.	PAGE
MGT3233X94	223
MGT3235150	223
MGT3240150	223
MGT3243123	223
MGT3253145	223
NY13020500	226
NY13021000	226
NY13041000	226
NY13045200	226
NY25020200	226
NY25021000	226
NY25041000	226
NY25045200	226
NY47020100	224
NY47045100	224
NYL1320200	226
NYL1321000	226
NYL1341000	226
NYL1345200	226
NYL2520200	226
NYL2521000	226
NYL2541000	226
NYL2545200	226
NYL4720100	224
NYL4745100	224
NYP2545200	226
NYP3045200	226
PC47020100	225
PCT0151001	238
PCT0151700	238
PCT0501000	238
PCT0501002	238
PCT0502000	238
PCT0502002	238
PES1320200	227
PES1345200	227
PES2520200	227
PES252250S	227
PES2545200	227
PES254550S	227
PES4702000	225
PES4702001	225
PF001000-2	232
PF10010001	232
PFXL0110-1	232
PFXL0110-2	232
PHMER/1000	205
PHMER/2000	205
PHMER/5003	205
PHMER/5004	205
PHMERO/100	205
PHMERO/250	205
PHMERO0/50	205
PIL0030120	233
PIL0041020	233
PMR00/1000	206
PMR00/2000	206
PMR00/5003	206
PMR00/5004	206
PMR00/100	206
PMR000/100	206
PMR000/250	206
PMR0000/50	206

ART. NO.	PAGE
PMRCAL1000	207
PMRCAL2000	207
PPD-90143A	233
PPD-90143E	233
PPH1320200	227
PPH1345200	227
PPH2520200	227
PPH2545200	227
PPL1320200	227
PPL1321000	227
PPL1341000	227
PPL1345200	227
PPL2520200	227
PPL2521000	227
PPL2541000	227
PPL2545200	227
PPP0110000	229
PPP0120000	229
PSC0603000	211
PSC0603001	211
PTF1320200	226
PTF1321000	226
PTF1341000	226
PTF1345200	226
PTF2520200	226
PTF2521000	226
PTF2541000	226
PTF2545200	226
PTH1320200	226
PTH1345200	226
PTH2520200	226
PTH2545200	226
PUC1501000	211
PUC1501001	211
PV17045200	227
PV30020200	227
PV30041000	227
PV30045200	227
PVD1320200	227
PVD1321000	227
PVD1341000	227
PVD1345200	227
PVD2520200	227
PVD2521000	227
PVD2545200	227
PVP2520200	227
PVP2545200	227
RC000P1000	231
RC000P5200	231
RM42520060	223
RM42520075	223
RMPE125100	224
RMPE125500	224
RMPE210100	224
RMPE210500	224
RR000P1000	231
RR000P5200	231
RR00PC1000	231
RR00PC5200	231
TMQ3216X50	223
TMQ3222X80	223
TMQ3225X60	223

ART. NO.	PAGE
TMQ3226X60	223
TMQ3228100	223
TMQ3228X60	223
TMQ3230100	223
TMQ3230X70	223
TMQ3230X77	223
TMQ3233X94	223
TMQ3235150	223
TMQ3240150	223
TMQ3243123	223
TMQ3253145	223
TP0006000S	228
TP0014004S	228
TP002500NI	228
TP005000PA	228
TP010000PX	228
TP0111000R	228
TP0114000R	228
TP0209000S	228
TP040000PX	228
TP0410000S	228
TP050000NA	228
TP050000PA	228
TP7514000S	228
AG0008	510
AG0010	510
AG0014	509
AG0015	509
AG0016	509
AG0019	85
AG0020	85
AG0030	85
AG0031	85
AG0032	85
AG0034	85
AG0036	86
AL0025	86
AL0030	86
AL0035	86
AL0070	140
AL0126	106
AL0127	106
AL0128	106
AL0160	117
AL0161	118
AL0162	117
AL0170	128
AL0171	128
AL0173	128
AL0175	128
AL0176	128
AL0177	129
AL0180	129
AL0181	129
AL0183	129
AL0190	143
AL0225	254
AL0235	466
AL0236	466
AL0245	339
AL0270	238
AL0285	261

ART. NO.	PAGE
AL0293	262
AL0295	262
AL0296	262
AL0309	374
AL0310	372
AL0311	372
AL0312	372
AL0315	373
AL0316	373
AL0317	374
AL0319	374
AL0321	373
AL0322	375
AL0326	374
AL0330	193
AL0393	323
AL0395	323
AL0436	371
AL0437	371
AL0438	371
AL0439	371
AL0515	296
AL0535	153
AL0580	342
AL0715	465
AL0718	465
AL0719	466
AL0740	88
AL0745	90
AL0746	90
AL0751	440
AL0754	455
AL0755	435
AL0760	87
AL0770	88
AL0795	88
AL0820	89
AL0830	89
AL0835	89
AL0836	89
AL0837	89
AL0850	89
AL0855	90
AL0860	90
ALA01G-06T	606
ALA500-03L	606
ALA500-06T	606
AM0025	87
AM0055	291
AM0095	489
AM0210	91
AM0230	95
AM0236	453
AM0247	93
AM0248	93
AM0249	92
AM0250	92
AM0251	91
AM0253	95
AM0254	95
AM0255	95
AM0256	92

ART. NO.	PAGE
AM0257	92
AM0258	93
AM0259	95
AM0265	96
AM0266	96
AM0267	97
AM0268	96
AM0269	94
AM0270	97
AM0271	95
AM0272	94
AM0273	98
AM0274	98
AM0276	98
AM0310	100
AM0312	100
AM0320	99
AM0330	100
AM0332	100
AM0334	98
AM0335	98
AM0349	99
AM0350	99
AM0364	103
AM0365	103
AM0370	103
AM0371	103
AM0395	96
AM0398	104
AM0400	104
AM0401	104
AM0410	104
AM0418	105
AM0419	104
AM0420	105
AM0465	102
AM0467	102
AM0468	105
AM0480	101
AN0030	323
AN0040	84
AN0073	301
AN0075	302
AN0090	512
AN0154	74
AN0155	74
AN0200	151
AN0215	341
AN0217	341
AN0230	342
AN0250	283
AN0320	468
AN0345	106
AN0347	107
AN0400	107
AN0401	107
AN0420	107
AN0440	441
AN0442	436
AN0445	455
AN0450	108
AQ0001	266

ART. NO.	PAGE
AQ0003	266
AQ0004	266
AQ0005	266
AQ0006	266
AQ0007	266
AQ0008	267
AQ0009	267
AQ0011	267
AQ0012	268
AQ0014	267
AQ0017	267
AQ0018	267
AQ0019	268
AQ0020	268
AQ0021	268
AQ0025	268
AQ0029	267
AQ0030	269
AR0100	384
AR0101	385
AR0120	108
AR0125	108
AR0151	441
AR0152	436
AR0153	456
AR0156	455
AS0015	109
AZ0040	470
AZ0041	471
AZ0100	107
AZ0125	125
AZ0130	126
AZ0155	196
AZ0175	271
AZ0200	299
AZ0203	299
AZ0205	305
AZ0206	299
AZ0220	121
AZ0225	487
AZ0226	487
AZ0235	494
AZ0345	507
AZ0365	110
AZ0390	110
AZ0391	110
BA0010	441
BA0011	436
BA0016	456
BA0030	140
BA0040	111
BA0053	111
BA0055	111
BA0056	111
BA0060	192
BA0063	112
BA0065	112
BA0073	112
BA0075	112
BA0080	113
BAG0400-01	687
BAG0400-02	687

ART. NO.	PAGE
BAG0400-03	687
BASRBBLPRE	615
BASRBBSIL	615
BASVAMCR12	615
BASVAMRB12	615
BASVTRCR12	615
BASVTRRB12	615
BE0040	114
BE0075	118
BE0155	114
BE0160	114
BE0185	118
BE0210	298
BE0245	116
BE0270	115
BE0346	456
BI0033	119
BI0090	299
BI0091	299
BI0130	441
BI0131	436
BI0136	456
BI0200	120
BI0225	120
BO0013	441
BO0014	436
BO0018	456
BPTSILSCAP	616
BR0017	122
BR0030	123
BR0060	124
BR0070	122
BR0120	125
BR0131	454
BR0168	233
BR0200	480
BR0269	126
BR0270	126
BR0275	127
BRMRRTD100	661
BRMRRTD250	661
BU0020	130
BU0022	130
C1801G-06T	607
C1802G-12A	607
C18050-01C	607
C1805G-20A	607
C18100-01C	607
C181000-0L	607
C1810G-60B	607
C18200-03L	607
C18300-00L	607
C18500-00L	607
C18500-03L	607
C18500-06T	607
C18500-10L	607
C8E200-15L	607
C8E500-03L	607
CA0041	441
CA0042	436
CA0045	456
CA0048	132

ART. NO.	PAGE
CA0050	132
CA0060	132
CA0080	132
CA0097	133
CA0100	133
CA0110	133
CA0150	133
CA0165	134
CA0170	392
CA0176	442
CA0177	437
CA0178	454
CA0180	134
CA0181	456
CA0182	134
CA0184	134
CA0185	135
CA0190	135
CA0192	135
CA0193	136
CA0194	136
CA0195	136
CA0197	135
CA0198	136
CA0199	135
CA0200	139
CA0203	136
CA0205	139
CA0210	137
CA0211	137
CA0215	137
CA0216	137
CA0225	138
CA0230	138
CA0231	138
CA0260	138
CA0284	139
CA0285	139
CA0346	143
CA0350	144
CA0351	143
CA03530100	610
CA03531000	610
CA0370	376
CA0380	141
CA0393	269
CA0394	269
CA0396	269
CAL-000010	643
CAL-000025	643
CAL-000050	643
CAL-000100	643
CAL-000250	643
CAL-000500	643
CAL-001000	643
CAPLUERO-C	611
CAPTOP-01C	611
CAPTOP-03C	611
CAPTOP-06C	611
CAPTOP-12C	611
CAPTOP-20C	611
CAPTOP-60L	611

ART. NO.	PAGE
CE0038	456
CE0050	97
CE0060	97
CE0080	142
CE0090	142
CE0101	142
CE0102	142
CE0108	457
CE0110	143
CE0121	143
CEA1320200	585, 680
CEA1345200	585, 680
CEA2520200	585, 680
CEA2545200	585, 680
CEP2520200	680
CEP2545200	680
CF2LAF0125	670
CF2LAF0150	670
CF2LAF0185	670
CF2LAF0240	670
CF2LAF0320	670
CF2LAG0090	670
CF2LAG0110	670
CF2LAG0125	670
CF2LAG0150	670
CF2LAG0185	670
CF2LAG0240	670
CF2LAG0320	670
CF2LAM0090	671
CF2LAM0110	671
CF2LAM0125	671
CF2LAM0150	671
CF2LAM0185	671
CF2LAM0240	671
CF2LAM0320	671
CF2LAP0090	671
CF2LAP0110	671
CF2LAP0125	671
CF2LAP0150	671
CF2LAP0185	671
CF2LAP0240	671
CF2LAP0320	671
CF2LAS0090	671
CF2LAS0110	671
CF2LAS0125	671
CF2LAS0150	671
CF2LAS0185	671
CF2LAS0240	671
CF2LAS0320	671
CF2STAE090	672
CF2STAE110	672
CF2STAE130	672
CF2STAE150	672
CF2STAE185	672
CF2STAE200	672
CF2STAE250	672
CF2STAE300	672
CF2STAF090	673
CF2STAF110	673
CF2STAF125	673
CF2STAF150	673
CF2STAF185	673

ART. NO.	PAGE
CF2STAF240	673
CF2STAF320	673
CF2STAM090	673
CF2STAM110	673
CF2STAM125	673
CF2STAM150	673
CF2STAM185	673
CF2STAM240	673
CF2STAM320	673
CF2STAR090	672
CF2STAR110	672
CF2STAR125	672
CF2STAR150	672
CF2STAR185	672
CF2STAR240	672
CF2STAR270	672
CF2STAR320	672
CF2WAE0110	668
CF2WAE0125	668
CF2WAE0150	668
CF2WAE0185	668
CF2WAE0240	668
CF2WAE0270	668
CF2WAF0110	668
CF2WAF0125	668
CF2WAF0150	668
CF2WAF0185	668
CF2WAF0240	668
CF2WAF0270	668
CF2WAFH110	667
CF2WAFH125	667
CF2WAFH150	667
CF2WAFH185	667
CF2WAFH240	667
CF2WAFH270	667
CF2WAG0110	668
CF2WAG0125	668
CF2WAG0150	668
CF2WAG0185	668
CF2WAG0240	668
CF2WAG0270	668
CF2WAG0320	668
CF2WAM0110	669
CF2WAM0125	669
CF2WAM0150	669
CF2WAM0185	669
CF2WAM0240	669
CF2WAM0270	669
CF2WAM0320	669
CF2WAMH110	667
CF2WAMH125	667
CF2WAMH150	667
CF2WAMH185	667
CF2WAMH240	667
CF2WAMH270	667
CF2WAP0110	669
CF2WAP0125	669
CF2WAP0150	669
CF2WAP0185	669
CF2WAP0240	669
CF2WAP0270	669
CF2WAP0320	669

ART. NO.	PAGE
CF2WAP0320	670
CF2WAS0110	669
CF2WAS0125	669
CF2WAS0150	669
CF2WAS0185	669
CF2WAS0240	669
CF2WAS0270	669
CF2WAS0320	669
CF2WASH110	667
CF2WASH125	667
CF2WASH150	667
CF2WASH185	667
CF2WASH240	667
CF2WASH270	667
CF2WAT0110	670
CF2WAT0125	670
CF2WAT0150	670
CF2WAT0185	670
CF2WAT0240	670
CF2WAT0270	670
CFILAF0047	670
CFILAF0055	670
CFILAF0070	670
CFILAF0090	670
CFILAF0110	670
CFILAF0125	670
CFILAF0150	670
CFILAF0185	670
CFILAF0240	670
CFILAG0047	670
CFILAG0055	670
CFILAG0070	670
CFILAG0090	670
CFILAG0110	670
CFILAG0125	670
CFILAG0150	670
CFILAG0185	670
CFILAG0240	670
CFILAG0320	670
CFILAM0047	671
CFILAM0050	671
CFILAM0055	671
CFILAM0070	671
CFILAM0090	671
CFILAM0110	671
CFILAM0125	671
CFILAM0150	671
CFILAM0185	671
CFILAM0240	671
CFILAP0047	671
CFILAP0050	671
CFILAP0055	671
CFILAP0070	671
CFILAP0090	671
CFILAP0110	671
CFILAP0125	671
CFILAP0150	671
CFILAP0185	671
CFILAP0240	671
CFILAP0320	671
CFILAS0047	671
CFILAS0050	671

ART. NO.	PAGE
CFILAS0055	671
CFILAS0070	671
CFILAS0090	671
CFILAS0110	671
CFILAS0125	671
CFILAS0150	671
CFILAS0185	671
CFILAS0240	671
CFILAT0047	672
CFILAT0050	672
CFILAT0055	672
CFILAT0070	672
CFILAT0090	672
CFILAT0110	672
CFILAT0125	672
CFILAT0150	672
CFILAT0185	672
CFILAT0240	672
CFILAT0320	672
CFISTAE090	672
CFISTAE110	672
CFISTAE125	672
CFISTAE130	672
CFISTAE150	672
CFISTAE200	672
CFISTAE250	672
CFISTAF090	673
CFISTAF110	673
CFISTAF125	673
CFISTAF150	673
CFISTAF185	673
CFISTAF240	673
CFISTAF320	673
CFISTAM090	673
CFISTAM110	673
CFISTAM125	673
CFISTAM130	673
CFISTAM150	673
CFISTAM185	673
CFISTAM240	673
CFISTAM320	673
CFISTAR090	672
CFISTAR110	672
CFISTAR125	672
CFISTAR130	672
CFISTAR150	672
CFISTAR185	672
CFISTAR240	672
CFISTAR270	672
CFISTAR320	672
CFISTAS125	673
CFISTAS185	673
CFISTAS240	673
CFISTAS320	673
CFIWAE0047	668
CFIWAE0050	668
CFIWAE0055	668
CFIWAE0070	668
CFIWAE0090	668
CFIWAE0110	668
CFIWAE0125	668
CFIWAE0150	668

ART. NO.	PAGE
CFIWAE0185	668
CFIWAE0240	668
CFIWAE0320	668
CFIWAF0047	668
CFIWAF0050	668
CFIWAF0055	668
CFIWAF0070	668
CFIWAF0090	668
CFIWAF0110	668
CFIWAF0125	668
CFIWAF0150	668
CFIWAF0185	668
CFIWAF0240	668
CFIWAFH047	667
CFIWAFH050	667
CFIWAFH055	667
CFIWAFH070	667
CFIWAFH090	667
CFIWAFH110	667
CFIWAFH125	667
CFIWAFH150	667
CFIWAFH185	667
CFIWAFH240	667
CFIWAG0047	668
CFIWAG0050	668
CFIWAG0055	668
CFIWAG0070	668
CFIWAG0090	668
CFIWAG0110	668
CFIWAG0125	668
CFIWAG0150	668
CFIWAG0185	668
CFIWAG0240	668
CFIWAG0320	668
CFIWAM0047	669
CFIWAM0050	669
CFIWAM0055	669
CFIWAM0070	669
CFIWAM0090	669
CFIWAM0110	669
CFIWAM0125	669
CFIWAM0150	669
CFIWAM0185	669
CFIWAM0240	669
CFIWAMH047	667
CFIWAMH050	667
CFIWAMH055	667
CFIWAMH070	667
CFIWAMH090	667
CFIWAMH110	667
CFIWAMH125	667
CFIWAMH150	667
CFIWAMH185	667
CFIWAMH240	667
CFIWAP0047	669
CFIWAP0050	669
CFIWAP0055	669
CFIWAP0070	669
CFIWAP0090	669
CFIWAP0110	669
CFIWAP0125	669
CFIWAP0150	669

ART. NO.	PAGE
CFIWAP0185	669
CFIWAP0240	669
CFIWAP0320	669
CFIWAS0047	669
CFIWAS0050	669
CFIWAS0055	669
CFIWAS0070	669
CFIWAS0090	669
CFIWAS0110	669
CFIWAS0125	669
CFIWAS0150	669
CFIWAS0185	669
CFIWAS0240	669
CFIWASH047	667
CFIWASH050	667
CFIWASH055	667
CFIWASH070	667
CFIWASH090	667
CFIWASH110	667
CFIWASH125	667
CFIWASH150	667
CFIWASH185	667
CFIWASH240	667
CFIWAT0047	670
CFIWAT0050	670
CFIWAT0055	670
CFIWAT0070	670
CFIWAT0090	670
CFIWAT0110	670
CFIWAT0125	670
CFIWAT0150	670
CFIWAT0185	670
CFIWAT0240	670
CFIWAT0320	670
CHAREMP-10	587
CHAREMP-60	587
CHARSIL05G	587
CHARSIL25G	587
CI0021	454
CI0028	163
CI0031	162
CI0032	163
CI0035	163
CI0036	163
CI0038	163
CI0039	163
CI0040	164
CI0042	164
CI0050	164
CI0060	165
CI0070	165
CI0126	445
CI0127	440
CI0129	464
CI0145	513
CI0150	513
CI0151	513
CI0155	514
CI0159	513
CI0160	514
CI0162	514
CI0180	515

ART. NO.	PAGE
CI0185	514
CI0195	514
CI0200	515
CI0205	516
CI0206	515
CI0207	516
CI0230	516
CI0231	516
CI0256	464
CI0305	166
CI0315	166
CIAGPEEK14	662
CIAGPEEK29	662
CL0010	144
CL0020	144
CL0025	145
CL0110	146
CL0111	146
CL0113	146
CL0119	147
CL0120	147
CL0125	150
CL0160	150
CL0199	149
CL0200	147
CL0202	149
CL0203	148
CL0204	148
CL0207	148
CL0208	149
CL0210	147
CL0213	149
CL0215	149
CL0218	148
CL0219	149
CL0229	454
CL0230	83
CL0250	119
CL0270	116
CL0329	172
CL0330	174
CL0331	172
CL0332	173
CL0335	174
CL0337	175
CL0338	173
CL0340	174
CL0341	174
CL0342	173
CL0345	174
CL0346	174
CL0347	173
CL0349	174
CL0350	175
CL0355	484
CN001G-06T	607
CN0100-01C	607
CN0200-03L	607
CN0500-03L	607
CN0500-06T	607
C00012	442
C00014	457

ART. NO.	PAGE
C00016	437
C00025	154
C00027	154
C00045	155
C00046	155
C00075	155
C00077	155
C00081	457
C00085	442
C00086	437
C00087	159
C00088	158
C00091	158
C00092	157
C00093	156
C00095	157
C00096	159
C00097	157
C00098	158
C00099	159
C00100	157
C00101	160
C00102	160
C00112	157
C00150	155
C00180	150
C00190	156
C00192	156
C00221	156
CR0062	160
CR0082	161
CR0095	161
CR0175	152
CR0186	454
CR0190	151
CR0194	151
CR0210	151
CR0222	442
CR0223	437
CR0227	457
CR0235	152
CR13021000	584, 679
CR13041000	584, 679
CR25020200	584, 679
CR25021000	584, 679
CR25041000	584, 679
CR25045200	584, 679
CRIMCAP11E	615
CRIMCAP20M	616
CT32510X50	675
CT32519x90	675
CT32520X80	675
CT32522100	675
CT32525X60	675
CT32525X80	675
CT32526100	675
CT32526X60	675
CT32528100	675
CT32528120	675
CT32530100	675
CT32530X80	675
CT32530X95	675

ART. NO.	PAGE
CT32533100	675
CT32533118	675
CT32535120	675
CT32535150	675
CT32540150	675
CT32548145	675
DE0010	120
DE0020	167
DE0037	169
DE0040	169
DI0030	169
DI0300	170
DI0315	170
DI0382	171
DI0407	171
DI0409	171
DI0411	172
DI0412	171
DI0415	175
DI0425	172
DI0470	175
DI0472	176
DI0485	176
DI0486	176
DI0562	176
DI0572	177
DI0573	177
DI0580	177
DI0630	192
DI0633	192
DI0650	192
DI0660	192
DI0810	180
DI0825	180
DI0827	180
DI0840	181
DI0855	181
DI0856	182
DI0858	182
DI0860	182
DI0861	182
DI0862	182
DI0870	183
DI0900	183
DI0935	183
DI0937	184
DI0972	184
DI0975	184
DI1010	186
DI1061	184
DI1063	186
DI1065	185
DI1068	185
DI1070	186
DI1071	185
DI1072	185
DI1074	185
DI1076	186
DI1080	186
DI1115	189
DI1155	190
DI1287	190

ART. NO.	PAGE
DI1288	191
DI1289	191
DI1290	191
DI1294	191
DI1298	191
DI1360	193
DP0050	193
DRG200-03L	608
DRG300-10L	608
DRG500-06T	608
DT0001	167
DT0002	168
DT0003	168
DT0004	168
DT0005	168
DT0006	168
DUQ0000060	664
DUQ0000100	664
DUQ0000125	664
DUQ0000250	664
DUQ0000500	664
DUQ0001000	664
DUQ0002000	664
EAX030-01C	610
EAX200-06T	610
EAX500-06T	610
EB2200-06T	609
EBH030-01C	609
EBH060-03L	609
EBH200-06T	609
EBH500-06T	609
ECX030-01C	610
ECX060-03L	610
ECX200-06T	610
ECX500-06T	610
EM47020100	677
EM47045100	677
EMC4720100	677
EMC4720100	582
EMC4745100	677
EMC4745100	582
EMP2FR-01C	611
EMP2FR-03C	611
EMP2FR-06C	611
EMP2FR-12C	611
EMP2FR-20C	611
EMP2FR-60C	611
EMPTY0-01C	611
EMPTY0-03C	611
EMPTY0-06C	611
EMPTY0-12C	611
EMPTY0-20C	611
EMPTY0-60C	611
E00025	194
E00026	195
E00055	194
E00056	194
E00057	194
E00058	194
EP0030	195
ER0031	457
ER0050	196

ART. NO.	PAGE
ES0021	462
ES0051	487
ES0061	445
ES0062	440
ES0063	488
ES0064	488
ES0065	488
ES0066	463
ES0070	488
ES0140	467
ES0177	445
ES0178	440
ES0180	467
ES0181	462
ES47020100	678
ES4702010N	678
ES47045100	678
ET0001	200
ET0002	197
ET0003	198
ET0004	199
ET0005	197
ET0006	197
ET0010	198
ET0011	198
ET0013	199
ET0015	198
ET0027	200
ET0028	200
ET0032	198
ET0073	179
ET0074	179
ET0077	178
ET0078	178
ET0079	178
ET0080	178
ET0082	179
ET0083	179
ET0086	181
ET0087	181
ET0088	333
ET0090	333
ET0092	333
ET0095	333
ET0096	334
ET0098	334
ET0099	334
ET0100	334
ET0101	335
ET0108	201
ET0109	201
ET0110	204
ET0113	204
ET0135	204
ET0137	204
ET0145	204
ET0164	208
ET0166	208
ET0175	208
ET0180	208
ET0181	209
ET0182	209

ART. NO.	PAGE
ET0190	209
ET0192	209
ET0205	264
EU0025	211
EU0052	457
EXTRAVAC12	611
EXTRAVAC20	611
FE0100	335
FE0180	338
FE0315	339
FE0478	336
FE0479	336
FE0480	335
FE0482	336
FE0484	336
FE0495	336
FE0496	337
FE0525	338
FE0529	212
FL0113	212
FL0122	213
FL0141	454
FLAC1804GA	586
FLAC1804GA	586
FLAC1812GA	586
FLAC18330G	586
FLASIL04GA	586
FLASIL120X	586
FLASIL12GA	586
FLASIL220G	586
FLASIL25GE	586
FLASIL330G	586
FLASIL40GE	586
FLASIL80GF	586
FLLN1812GA	587
FLLN1820GA	587
FLLN1840GX	587
FLLN1880GV	587
FLLNS1120V	587
FLLNS112GA	587
FLLNS120GA	587
FLLNS140GX	587
FLLNS180GV	587
FLLS18120V	587
FLLS1812GA	587
FLLS1820GA	587
FLLS1840GX	587
FLLS1880GV	587
FLLSS1120V	587
FLLSS112GA	587
FLLSS120GA	587
FLLSS140GX	587
FLLSS180GV	587
FLO01G-06T	608
FLO02G-12A	608
FLO05G-20A	608
FLO500-03L	608
F00009	213
F00010	213
F00011	214
F00012	214
F00013	215

ART. NO.	PAGE
F00014	214
F00018	214
F00025	215
F00026	215
F00027	215
F00028	215
F00030	341
F00036	461
F00112	455
FRITPE-01C	611
FRITPE-03C	611
FRITPE-06C	611
FRITPE-12C	611
FRITPE-20C	611
FRITPE-60L	611
FT0025	210
FT0035	170
FT0045	179
FT0055	187
FU0055	219
FU0060	219
FU0065	219
FU0090	220
GA0011	457
GA0025	221
GA0036	458
GE0020	221
GE0030	387
GE0033	387
GE0042	386
GE0043	386
GE0048	386
GE0049	387
GE0050	387
GE0072	458
GL0023	226
GL0026	225
GL0027	225
GL0028	226
GL0110	222
GL0125	222
GL0127	223
GL0129	223
GL0131	454
GL0165	224
GL0168	224
GL0170	225
GLV-NSPOOL	689
GLV-NSP00M	689
GLV-NSP00S	689
GLV-NSP0XL	689
GLVBNSPOOL	689
GLVBNSP00M	689
GLVBNSP00S	689
GLVBNSP0XL	689
GMFA-50024	674
GMFA-50035	674
GMFA-50047	674
GMFA-50090	674
GMFA-50150	674
GMFB143024	674
GMFB143047	674

ART. NO.	PAGE
GMFB143090	674
GMFB143150	674
GMFC-52024	674
GMFC-52035	674
GMFC-52047	674
GMFC-52090	674
GMFC-52150	674
GMFD-12150	674
GMFD120024	674
GMFD120047	674
GMFD120090	674
GMFF-75024	674
GMFF-75037	674
GMFF-75047	674
GMFF-75090	674
GMFG-65037	674
GMFG-65047	674
G00020	228
GU0060	227
GU0061	227
GU0065	228
GU0115	227
HA0011	458
HE0011	230
HE0060	229
HE0070	229
HE0100	229
HE0118	231
HE0120	232
HE0123	230
HE0125	231
HE0127	231
HE0131	231
HE0135	231
HE0138	231
HE0200	233
HE0219	236
HE0220	236
HE0221	236
HE0222	236
HE0223	236
HE0227	234
HE0228	234
HE0231	235
HE0232	233
HE0233	235
HE0234	235
HE0238	235
HE0239	235
HE0241	234
HE0242	234
HE0248	234
HE0250	238
HIO090	240
HIO092	240
HIO110	240
HIO130	253
HIO132	252
HIO135	251
HIO136	251
HIO137	251
HIO138	251

ART. NO.	PAGE
HI0139	250
HI0143	252
HI0144	252
HI0145	253
HI0212	253
HI0215	254
HI0225	254
HI0235	255
HI0257	255
HI0291	459
HI0302	442
HI0303	259
HI0304	259
HI0305	437
HI0312	102
HI0314	101
HI0315	102
HI0316	101
HI0317	102
HI0318	101
HI0319	102
HI0333	259
HI0340	259
HI0341	260
HI0350	260
HI0351	260
HI0352	260
HI0360	261
HI0395	238
HI0405	239
HO0011	458
HY0001	239
HY0002	239
IM0025	256
IM0026	256
IN0040	305
IN0065	256
IN0088	458
IN0120	257
IP0010	258
IR0011	458
IS0122	263
IS0140	264
IS0153	500
IS0154	500
IS0156	500
IS0157	500
IS0160	501
IS0162	264
IS0167	500
IS0170	265
IS0175	265
IT0004	464
IT0011	464
KA0010	266
KE0101	269
KQ00230100	610
KQ00231000	610
KT0001	446
LA0045	211
LA0060	271
LA0075	222

ART. NO.	PAGE
LA0081	459
LA0090	271
LA0100	272
LA0110	272
LE0055	275
LE0070	218
LI0035	278
LI0060	443
LI0061	438
LI0062	454
LI0064	459
LI0090	277
LI0100	276
LI0110	276
LI0112	276
LI0140	276
LI0141	276
LI0175	277
LI0180	277
LLE-20C000	613
LU0010	278
LU0016	459
MA0011	443
MA0012	438
MA0013	454
MA0016	459
MA0025	279
MA0027	279
MA0028	279
MA0035	279
MA0036	280
MA0037	280
MA0040	281
MA0048	280
MA0050	280
MA0055	280
MA0060	281
MA0080	281
MA0081	281
MA0084	282
MA0085	282
MA0086	282
MA0087	282
MA0100	284
MA0111	443
MA0112	438
MA0116	459
MA0120	284
MA0122	285
MA0123	285
MA0125	285
MA0126	285
MA0130	286
MA0131	286
MA0149	286
MA0150	286
MA0160	286
MCE1320200	584, 679
MCE1345200	584, 679
MCE2520200	584, 679
MCE2545200	584, 679
ME0095	287

ART. NO.	PAGE
ME0111	443
ME0112	438
ME0116	460
ME0120	288
ME0121	288
ME0160	288
ME0169	288
ME0170	289
ME0175	287
ME0193	289
ME0195	289
ME0197	290
ME0213	290
ME0214	290
ME0215	290
ME0226	291
ME0227	291
ME0250	289
ME0298	294
ME0301	291
ME0302	292
ME0304	295
ME0306	293
ME0312	295
ME0314	294
ME0315	292
ME0318	293
ME0319	294
ME0320	297
ME0324	294
ME0325	294
ME0326	293
ME0329	295
ME0330	296
ME0334	293
ME0337	292
ME0339	293
ME0350	297
ME0355	298
ME0376	262
ME0390	298
ME0454	210
ME0455	211
ME0457	210
ME0478	300
ME0490	301
ME0492	303
ME0493	301
ME0494	302
ME0495	302
ME0496	302
ME0503	302
ME0513	306
ME0514	301
ME0515	306
ME0550	131
ME0551	131
ME0552	131
ME0553	131
ME0558	131
ME0590	303
ME0605	306

ART. NO.	PAGE
ME0665	296
ME0680	269
ME0736	123
ME0790	306
MFQ-85T037	675
MFQ-85T047	675
MFQ-85T090	675
MFQ-85T150	675
MGT3210X50	676
MGT3216X50	676
MGT3222X80	676
MGT3225100	676
MGT3225X60	676
MGT3226X60	676
MGT3228100	676
MGT3228X60	676
MGT3230100	676
MGT3230X70	676
MGT3230X77	676
MGT3233X94	676
MGT3235150	676
MGT3240150	676
MGT3243123	676
MGT3253145	676
MI0020	265
MO0021	443
MO0022	438
MO0024	460
MO0025	307
MO0050	307
MO0070	307
MU0020	308
MU0111	465
MU0112	464
MU0113	465
MU0114	464
NA0024	309
NA0026	309
NA0047	310
NA0110	309
NA0112	309
NA0116	310
NA0117	310
NA0135	310
NE0025	90
NE0035	196
NE0045	195
NE0048	196
NE0050	468
NE0064	460
NH201G-06T	607
NH2100-01C	607
NH2500-03L	607
NH2500-06T	607
NH2500-15L	607
NI0020	313
NI0035	313
NI0062	314
NI0071	460
NI0121	444
NI0122	439
NI0123	455

ART. NO.	PAGE
NIO126	460
NIO132	311
NIO138	312
NIO139	312
NIO150	312
NIO179	312
NIO180	313
NIO192	454
NIO270	318
NIO273	319
NIO335	319
NIO343	320
NIO345	320
NIO348	320
NY13020500	583, 679
NY13021000	583, 679
NY13041000	583, 679
NY13045200	583, 679
NY25020200	583, 679
NY25021000	583, 679
NY25041000	583, 679
NY25045200	583, 679
NY47020100	677
NY47045100	677
NYL1320200	583, 679
NYL1321000	583, 679
NYL1341000	583, 679
NYL1345200	583, 679
NYL2520200	583, 679
NYL2521000	583, 679
NYL2541000	679
NYL2541000	583, 679
NYL2545200	679
NYL2545200	583, 679
NYL4720100	677
NYL4720100	582
NYL4745100	677
NYL4745100	582
NYP2545200	679
NYP3045200	679
OC0010	321
OR0020	323
OR0021	324
OR0022	324
OR0035	324
OR0055	324
OR0057	442
OR0058	437
OR0060	431
OR0063	458
OS0056	460
PA0025	326
PA0066	460
PA0095	327
PA0099	453
PA0100	453
PA0101	453
PA0102	453
PA0103	453
PA0112	327
PA0113	327
PA0114	327

ART. NO.	PAGE
PA0150	119
PC47020100	678
PCB01G-03L	608
PCB01G-06L	608
PCT0151000	691
PCT0151001	691
PCT0501000	691
PCT0501002	691
PCT0502000	691
PCT0502002	691
PE0070	328
PE0092	328
PE0095	328
PE0096	328
PE0097	329
PE0099	329
PE0100	329
PE0102	329
PE0120	330
PE0125	330
PE0160	117
PE0165	116
PES1320200	585, 680
PES1345200	585, 680
PES2520200	585, 680
PES252250S	585, 680
PES2545200	585, 680
PES254550S	585, 680
PES4702000	678
PES4702001	678
PF001000-2	685
PF10010001	685
PFXL0110-1	685
PFXL0110-2	685
PHMER/1000	659
PHMER/2000	659
PHMER/5003	659
PHMER/5004	659
PHMERO/100	659
PHMERO/250	659
PHMERO0/50	659
PIO010	376
PIO050	343
PIO061	343
PIO100	378
PIO121	377
PIO123	377
PIO124	377
PIO125	378
PIO126	378
PIO127	377
PIO132	378
PIO150	379
PIL0030120	686
PIL0041020	686
PL0005	444
PL0006	439
PL0008	462
PL0010	389
PL0030	389
PL0049	389
PL0050	389

ART. NO.	PAGE
PL0051	391
PL0055	390
PL0056	390
PL0057	390
PL0058	390
PL0059	390
PL0060	391
PL0070	391
PL0071	391
PL0072	392
PL0073	392
PL0105	443
PL0106	438
PL0108	459
PL0114	273
PL0115	273
PL0120	273
PL0135	273
PL0140	274
PL0145	274
PL0150	274
PL0151	274
PL0155	275
PLUNGER-10	587
PLUNGER-60	587
PMR00/1000	660
PMR00/2000	660
PMR00/5003	660
PMR00/5004	660
PMR000/100	660
PMR000/250	660
PMR0000/50	660
PMRCAL1000	661
PMRCAL2000	661
P00025	344
P00030	344
P00035	344
P00045	345
P00050	345
P00060	345
P00065	346
P00066	346
P00069	346
P00080	346
P00105	444
P00106	439
P00107	455
P00109	346
P00111	461
P00112	347
P00120	357
P00125	347
P00130	358
P00131	358
P00150	359
P00160	347
P00163	347
P00165	348
P00166	348
P00167	348
P00168	348
P00170	349

ART. NO.	PAGE
P00171	349
P00173	357
P00175	349
P00180	350
P00186	349
P00190	350
P00193	350
P00199	351
P00200	351
P00201	351
P00205	351
P00206	351
P00207	351
P00214	352
P00215	352
P00216	352
P00219	353
P00220	353
P00221	354
P00230	354
P00231	353
P00232	353
P00233	354
P00234	354
P00235	353
P00240	356
P00241	355
P00242	355
P00243	357
P00247	356
P00248	356
P00256	356
P00257	357
P00258	357
P00259	355
P00260	355
P00261	355
P00262	355
P00263	359
P00266	360
P00268	360
P00269	358
P00270	358
P00271	358
P00272	359
P00273	360
P00275	360
P00276	362
P00277	362
P00279	364
P00280	361
P00281	361
P00282	361
P00283	361
P00285	365
P00287	365
P00288	360
P00289	362
P00290	365
P00293	362
P00294	362
P00309	365

ART. NO.	PAGE
P00310	366
P00321	455
P00330	366
P00331	366
P00333	367
P00335	366
P00336	367
P00337	367
P00340	364
P00350	367
P00353	368
P00355	368
P00360	368
P00363	368
P00365	368
P00369	369
P00370	369
P00372	369
P00375	370
P00380	369
P00400	363
P00401	363
P00404	363
P00410	364
P00411	363
P00415	364
PPD-90143A	686
PPD-90143E	686
PPH1320200	585, 680
PPH1345200	585, 680
PPH2520200	585, 680
PPH2545200	585, 680
PPL1320200	584, 680
PPL1321000	584, 680
PPL1341000	584, 680
PPL1345200	584, 680
PPL2520200	584, 680
PPL2521000	584, 680
PPL2541000	584, 680
PPL2545200	584, 680
PPP0110000	682
PPP0120000	682
PR0011	461
PR0025	370
PR0055	370
PR0085	376
PR0088	376
PRS500-03L	608
PRS500-10L	608
PS50010001	565
PS50020001	547
PS50030001	565
PS50040001	547
PS50050001	565
PS50060001	547
PS50070001	565
PS50080001	547
PS50090001	565
PS50100001	547
PS50110001	565
PS50120001	547
PS50130001	540

ART. NO.	PAGE
PS50140001	565
PS50150001	546
PS50160001	529
PS50170001	559
PS50180001	536
PS50190001	528
PS50200001	528
PS50210001	540
PS50220001	565
PS50230001	546
PS50240001	529
PS50250001	531
PS50260001	556
PS50270005	556
PS50300001	537
PS50310005	570
PS50330001	530
PS50340001	530
PS50350001	545
PS50360001	569
PS50370001	569
PS50380001	571
PS50390001	544
PS50400001	552
PS50420001	537
PS50430001	552
PS50440001	561
PS50450001	560
PS50470001	561
PS50480001	562
PS50500001	562
PS50510001	539
PS50520001	548
PS50530001	526
PS50540001	544
PS50550001	526
PS50560001	527
PS50570001	561
PS50580001	576
PS50590001	552
PS50600001	545
PS50610001	563
PS50620001	547
PS50630001	538
PS50640001	528
PS50650001	558
PS50660001	557
PS50670001	556
PS50690001	557
PS50700001	532
PS50710001	532
PS50720001	557
PS50730001	557
PS50740001	531
PS50750001	531
PS50760001	538
PS50770001	557
PS50790001	524
PS50800001	524
PS50810001	553
PS50830001	531
PS50840001	565

ART. NO.	PAGE
PS50850001	558
PS50860001	570
PS50870001	537
PS50880001	530
PS50890001	544
PS50900001	528
PS50910001	548
PS50920001	568
PS50930001	539
PS50940001	563
PS50950001	564
PS50960001	568
PS50970001	579
PS50980001	539
PS50990001	564
PS51000001	568
PS51020001	547
PS51030001	530
PS51040001	531
PS51050001	531
PS51060001	530
PS51070001	530
PS51080001	550
PS51090001	554
PS51100001	555
PS51110001	527
PS51120001	560
PS51130001	560
PS51140001	528
PS51150001	526
PS51160001	531
PS51170001	535
PS51180001	535
PS51190001	536
PS51200001	543
PS51210001	543
PS51220001	540
PS51230001	540
PS51240001	566
PS51250001	531
PS51260001	537
PS51270001	537
PS51280001	570
PS51290001	570
PS51300001	536
PS51320005	529
PS51330001	524
PS51340001	526
PS51350001	526
PS51360001	526
PS51370001	526
PS51380001	525
PS51390001	525
PS51400001	525
PS51410001	525
PS51420001	526
PS51430001	527
PS51440001	527
PS51450001	528
PS51450001	555
PS51460001	529
PS51470001	528

ART. NO.	PAGE
PS51480001	529
PS51490001	529
PS51500001	529
PS51510001	529
PS51520001	529
PS51530001	529
PS51540001	529
PS51550001	532
PS51560001	532
PS51570001	533
PS51580001	532
PS51590001	534
PS51600001	533
PS51610001	533
PS51620001	533
PS51630001	534
PS51640001	534
PS51650001	534
PS51660001	534
PS51670001	534
PS51680001	535
PS51690001	534
PS51700001	535
PS51710001	535
PS51720001	534
PS51730001	535
PS51740001	536
PS51770001	536
PS51780001	536
PS51790001	535
PS51800001	535
PS51810001	536
PS51820001	536
PS51830001	537
PS51840001	537
PS51850001	537
PS51860001	538
PS51880001	538
PS51890001	538
PS51910001	539
PS51920001	539
PS51930001	539
PS51940001	539
PS51950001	539
PS51960001	540
PS51970001	541
PS51980001	542
PS51990001	541
PS52000001	541
PS52010001	541
PS52020001	541
PS52030001	542
PS52070001	542
PS52080001	542
PS52090001	543
PS52100001	543
PS52110001	543
PS52120010	543
PS52130001	544
PS52140001	544
PS52180001	545
PS52200001	545

ART. NO.	PAGE
PS52220001	545
PS52240001	546
PS52250001	546
PS52260001	547
PS52280001	546
PS52290001	546
PS52300001	546
PS52310001	546
PS52320001	548
PS52330001	547
PS52340001	548
PS52350001	548
PS52360001	549
PS52370001	549
PS52380001	549
PS52390001	549
PS52400001	550
PS52410001	550
PS52420001	549
PS52430001	549
PS52440001	550
PS52450001	550
PS52460001	550
PS52470001	550
PS52480001	550
PS52490001	550
PS52500001	551
PS52510001	551
PS52520001	551
PS52530001	551
PS52540001	551
PS52550001	551
PS52570001	552
PS52580001	553
PS52590001	554
PS52600001	554
PS52610001	554
PS52620001	555
PS52630001	555
PS52640001	555
PS52650001	555
PS52660001	555
PS52670001	556
PS52680001	556
PS52690001	556
PS52700001	556
PS52710001	557
PS52730001	557
PS52740001	557
PS52750001	558
PS52760001	559
PS52770001	559
PS52780001	559
PS52790001	559
PS52800001	560
PS52810001	561
PS52820005	560
PS52840001	561
PS52850001	561
PS52860001	561
PS52870001	562
PS52880001	562

ART. NO.	PAGE
PS52890001	563
PS52900001	563
PS52910001	562
PS52920001	562
PS52930001	563
PS52940001	563
PS52950001	562
PS52960001	562
PS52970001	562
PS52980001	564
PS52990001	564
PS53000001	564
PS53020001	564
PS53030001	565
PS53040001	565
PS53050001	564
PS53060001	565
PS53070001	566
PS53080001	566
PS53090001	566
PS53100001	567
PS53110001	567
PS53120001	567
PS53130001	566
PS53140001	566
PS53170001	567
PS53180001	567
PS53190001	567
PS53200001	567
PS53210001	568
PS53220001	568
PS53230001	568
PS53240001	569
PS53250001	569
PS53280001	569
PS53300001	570
PS53320001	570
PS53330001	570
PS53340001	571
PS53350001	571
PS53360001	571
PS53370001	572
PS53380001	572
PS53390001	572
PS53400001	573
PS53410001	572
PS53420001	575
PS53430001	575
PS53440001	573
PS53450001	573
PS53460001	574
PS53470001	574
PS53480001	574
PS53500001	573
PS53510001	576
PS53520001	576
PS53540001	576
PS53550001	577
PS53560001	578
PS53570001	578
PS53580001	578
PS53590001	579

ART. NO.	PAGE
PS53600001	579
PS53610001	579
PS53620001	577
PS53630001	577
PS53640001	532
PS53650001	533
PS53660001	533
PS53670001	533
PS53680001	533
PS53690001	533
PS53700001	533
PS53710001	532
PS53720001	553
PS53730001	553
PS53740001	553
PS53750001	534
PS53760001	572
PS53770001	572
PSA01G-06T	609
PSA100-01C	609
PSA500-03L	609
PSA500-06T	609
PSC0603000	664
PSC0603001	664
PT0006	461
PTF1320200	584, 679
PTF1321000	584, 679
PTF1341000	584, 679
PTF1345200	584, 679
PTF2520200	584, 679
PTF2521000	584, 679
PTF2541000	584, 679
PTF2545200	584, 679
PTH1320200	584, 679
PTH1345200	584, 679
PTH2520200	584, 679
PTH2545200	584, 679
PU0020	125
PUC1501000	664
PUC1501001	664
PV17045200	680
PV30020200	680
PV30041000	680
PV30045200	680
PVD1320200	584, 680
PVD1321000	584, 680
PVD1341000	584, 680
PVD1345200	584, 680
PVD2520200	584, 680
PVD2521000	584, 680
PVD2545200	584, 680
PVP2520200	680
PVP2545200	680
QU0095	380
QUDISAONK2	613
QUDISENAK2	613
QUDISENNK2	613
QUEXTAOAK1	613
QUEXTCRAK1	613
QUEXTENAK1	613
QUEXTENBK1	613
QUEXTENCK1	613

ART. NO.	PAGE
QUEXTORAK1	613
RBBLSILCAP	615
RBRDSILCAP	615
RBWWSILPRE	615
RC000P1000	684
RC000P5200	684
RE0001	113
RE0002	113
RE0003	120
RE0004	196
RE0005	212
RE0006	212
RE0007	269
RE0008	158
RE0013	268
RE0015	311
RE0016	141
RE0017	141
RE0018	213
RE0020	229
RE0025	83
RE0040	305
RE0050	310
RE0057	304
RE0060	321
RE0065	187
RE0070	510
RE0078	461
RE0080	381
RE0083	381
RE0100	113
RI0025	381
RM42520060	676
RM42520075	676
RMPE125100	677
RMPE125500	677
RMPE210100	677
RMPE210500	677
RO0023	461
RO0030	381
RO0070	87
RO0071	87
RO0110	161
RO0130	337
RO0131	337
RO0150	303
RO0155	303
RO0156	304
RO0165	379
RO0190	311
RO0191	311
RR000P1000	684
RR000P5200	684
RR00PC1000	684
RR00PC5200	684
RU0021	461
RU0063	461
S11015100C	616
S20AC01000	616
S20AC0100A	616
S20AC0100R	616
SA0020	383

ART. NO.	PAGE
SA0021	383
SA0040	383
SA0042	384
SA0180	304
SA0200	384
SA0211	462
SA2200-10L	609
SAX01G-06T	608
SAX500-03L	608
SAX500-06T	608
SC10F12001	593
SC10F12005	593
SC11521006	588
SC11521071	588
SC12521007	588
SC12521047	588
SC13021008	588
SC13021063	588
SC13021078	588
SC13F13001	593
SC13F13005	593
SC13F13008	593
SC15021009	588
SC16021045	588
SC17157031	590
SC17157051	590
SC17307008	590
SC17307053	590
SC17307073	590
SC17607020	590
SC17607050	590
SC17F15001	593
SC17F15005	593
SC17F15008	593
SC17F16001	594
SC17F16005	594
SC17F16008	594
SC1F110001	593
SC1F110005	593
SC1F110008	593
SC1HT31001	596
SC1HT31002	596
SC1HT31003	596
SC1HT31011	596
SC1HT31017	596
SC1HT31022	596
SC20F17001	594
SC20F17005	594
SC20F17008	594
SC20F18001	594
SC20F18005	594
SC20F18009	594
SC21528046	590
SC21528061	590
SC22F19001	594
SC22F19005	594
SC22F19009	594
SC23028008	590
SC23028073	590
SC33024003	590
SC33024008	590
SC33024013	590

ART. NO.	PAGE
SC35159001	589
SC35309002	589
SC35309005	589
SC35309006	589
SC35609003	589
SC35F20001	594
SC35F20005	594
SC35F20008	594
SC36024005	590
SC36024010	590
SC50156011	589
SC50306003	589
SC50306008	589
SC50606065	589
SC50F22002	595
SC50F22004	595
SC51522016	589
SC51522086	589
SC53022008	589
SC53022053	589
SC53022078	589
SC53022093	589
SC53022098	589
SC54HT3301	596
SC54HT3302	596
SC54HT3305	596
SC54HT3313	596
SC54HT3319	596
SC54HT3324	596
SC56022010	589
SC56022035	589
SC56022090	589
SC5F210001	595
SC5F210005	595
SC5F210009	595
SC5HT32001	596
SC5HT32002	596
SC5HT32003	596
SC5HT32011	596
SC5HT32017	596
SC5HT32022	596
SC62F23001	595
SC62F23005	595
SC62F23010	595
SC62F23017	595
SC63026003	590
SC63026018	590
SC66026005	590
SC66026010	590
SCACF25001	595
SCACF25005	595
SCACF25008	595
SCF1525006	591
SCF1525061	591
SCF3025008	591
SCF3025028	591
SCF5025039	591
SCF6025010	591
SCMS110049	591
SCMS110050	591
SCMS110074	591
SCMS110099	591

ART. NO.	PAGE
SCMS170049	591
SCMS170050	591
SCMS170073	591
SCMS170086	591
SCMS170100	591
SCMS225021	592
SCMS225034	592
SCMS350050	592
SCMS350066	592
SCMS350094	592
SCMS350100	592
SCMS500044	592
SCMS500045	592
SCMS500046	592
SCMS500051	592
SCMS500052	592
SCMS500074	592
SCMS500075	592
SCMS624030	592
SCMS624055	592
SCMS624097	592
SCMSWAX037	593
SCMSWAX038	593
SCMSWAX044	593
SCMSWAX066	593
SCMSWAX103	593
SCW1523061	591
SCW3023008	591
SCW3023023	591
SCW3023053	591
SCW3023058	591
SCW6023065	591
SCWXHT4301	596
SCWXHT4302	596
SCWXHT4305	596
SCWXHT4313	596
SCWXHT4319	596
SCWXHT4324	596
SCX01G-06T	608
SCX02G-12A	608
SCX05G-20A	608
SCX500-03L	608
SD0010	421
SE0011	444
SE0012	439
SE0016	462
SE0025	385
SE0039	385
SE0070	385
SE0105	386
SI0012	444
SI0013	439
SI0016	462
SI0020	388
SI0025	388
SI0030	388
SI0033	388
SI0034	388
SI0040	388
SIL01G-06T	608
SIL02G-12A	608
SIL05G-20A	608

ART. NO.	PAGE
SIL100-01C	608
SIL500-03L	608
S00005	444
S00006	439
S00007	455
S00009	462
S00010	392
S00024	393
S00025	393
S00030	394
S00032	393
S00035	393
S00036	393
S00050	397
S00051	397
S00091	394
S00100	422
S00105	395
S00115	396
S00116	396
S00117	396
S00118	396
S00119	395
S00123	396
S00125	394
S00126	394
S00128	406
S00129	406
S00130	406
S00131	406
S00133	406
S00150	409
S00160	409
S00170	395
S00171	395
S00190	400
S00199	400
S00200	400
S00205	400
S00210	397
S00213	397
S00224	397
S00225	398
S00226	398
S00227	398
S00228	399
S00229	399
S00230	398
S00231	399
S00233	399
S00234	398
S00240	405
S00250	399
S00257	401
S00260	401
S00270	401
S00289	403
S00290	403
S00323	404
S00324	404
S00325	404
S00326	404

ART. NO.	PAGE
S00328	403
S00329	407
S00330	402
S00331	403
S00332	402
S00333	403
S00334	402
S00335	407
S00336	408
S00337	407
S00338	408
S00339	408
S00340	426
S00341	426
S00342	426
S00343	408
S00345	408
S00347	426
S00349	407
S00350	407
S00355	404
S00400	405
S00412	413
S00415	405
S00417	409
S00418	410
S00419	410
S00420	410
S00421	412
S00422	411
S00423	412
S00424	411
S00425	411
S00426	412
S00427	418
S00428	418
S00429	417
S00430	414
S00431	419
S00432	419
S00433	413
S00434	418
S00435	427
S00436	419
S00438	418
S00439	418
S00440	414
S00441	415
S00442	415
S00443	417
S00444	416
S00445	416
S00447	417
S00448	417
S00449	416
S00450	421
S00451	414
S00452	415
S00453	417
S00455	414
S00456	421
S00457	415

ART. NO.	PAGE
S00458	421
S00460	420
S00464	416
S00465	417
S00473	410
S00489	422
S00490	423
S00499	421
S00500	423
S00501	423
S00505	423
S00510	424
S00512	424
S00520	424
S00529	424
S00530	424
S00531	425
S00535	425
S00540	425
S00555	425
S00564	422
S00565	422
S00583	485
S00590	427
S00615	427
S00633	427
S00640	428
S00645	468
S00662	428
S00664	428
S00665	428
S00667	428
S00669	429
S00670	428
S00671	429
S00672	429
S00673	429
S00675	431
S00700	430
S00704	430
S00705	430
S00707	431
S00720	431
S00725	432
S00727	432
S00728	433
S00729	432
S00730	432
S00731	433
S00732	432
S00733	433
S00734	433
S00736	433
S00737	433
S00738	434
S00755	434
S00780	434
S00795	434
S00825	419
S00835	420
S00837	420
S00850	435

ART. NO.	PAGE
S01004	447
S01005	447
S01006	448
S01007	448
S01008	448
S01009	449
S01010	449
S01012	193
S01013	127
S01022	446
S01023	447
S01025	447
S01028	448
S01050	326
S01051	326
S01092	449
S01101	446
S01141	449
S01142	450
S01143	450
S02004	450
S02007	451
S02010	451
S02040	452
S02070	452
S02100	452
S02200	452
S03004	450
S03007	451
S03010	451
SOLVBIOTAG	587
STOPCOCKVA	611
SU0030	383
SU0040	469
SU0045	469
SU0060	469
SU0102	462
SU0103	455
SU0119	187
SU0150	188
SU0151	188
SU0153	188
SU0155	188
SU0158	188
SU0159	189
SU0161	189
SU0165	188
SU0167	188
SU0170	141
SU0171	141
TA0010	479
TA0031	463
TA0140	307
TA0141	307
TA0201	463
TB0010	480
TE0023	463
TE0050	480
TE0080	189
TE0115	481
TE0116	481
TE0120	480

ART. NO.	PAGE
TE0125	482
TE0127	482
TE0219	482
TE0220	482
TE0221	482
TE0222	483
TE0223	483
TE0225	483
TE0228	483
TE0229	483
TE0230	484
TE0234	483
TE0240	484
TE0241	484
TIO010	387
TIO080	486
TIO100	487
TIO139	485
TIO140	485
TIO220	287
TIO250	486
TIO300	486
TIO303	486
TIO325	504
TIO329	489
TIO330	489
TIO360	445
TIO366	463
TIO367	489
TLCALI2020	614
TLCGLI2020	614
TLCPLI2020	614
TMQ3216X50	676
TMQ3222X80	676
TMQ3225X60	676
TMQ3226X60	676
TMQ3228100	676
TMQ3228X60	676
TMQ3230100	676
TMQ3230X70	676
TMQ3230X77	676
TMQ3233X94	676
TMQ3235150	676
TMQ3240150	676
TMQ3243123	676
TMQ3253145	676
T00068	491
T00069	491
T00072	490
T00074	490
T00075	490
T00077	491
T00080	493
T00081	491
T00082	491
T00083	492
T00084	492
T00085	491
T00086	492
T00087	492
T00120	493
T00280	277

ART. NO.	PAGE
TP0006000S	681
TP0014004S	681
TP002500NI	681
TP005000PA	681
TP010000PX	681
TP0111000R	681
TP0114000R	681
TP0209000S	681
TP040000PX	681
TP0410000S	681
TP050000NA	681
TP050000PA	681
TP7514000S	681
TR0030	494
TR0080	494
TR0119	496
TR0120	496
TR0150	496
TR0200	496
TR0202	497
TR0215	497
TR0216	497
TR0217	497
TR0218	497
TR0240	498
TR0260	498
TR0400	502
TR0422	501
TR0423	501
TR0424	502
TR0425	501
TR0427	501
TR0444	502
TR0447	502
TU0011	445
TU0012	440
TU0016	463
TW0020	503
TW0022	503
TW0040	503
TW0060	503
TW0080	504
UR0130	505
UR0131	505
UR0133	505
VA0025	506
VA0055	506
VA0071	445
VA0072	440
VA0076	463
VA0150	506
VAMCRIM12M	615
VAMRBCAPSM	615
VAMRBSLITM	615
VAMSN12X32	616
VAWBE12X32	615
VAWSN12X32	616
VE0060	122
VE0070	124
VE0075	124
VE0100	282
VE0101	283

ART. NO.	PAGE
VE0110	300
VE0120	300
VE0160	275
VI0025	162
VI0027	162
VI0032	221
VI0070	305
VI0150	507
VI0180	507
VPPRB12X32	615
VTRAM2246P	616
VTRCR2238P	616
VTRCR2346P	616
VTRCR2346R	616
VTRCR2375P	616
VTRCR2375R	616
VTRCRIM12M	615
VTRRBCAPSM	615
VTRRBSLITM	615
VTRSN12X32	616
VTWCR12X32	615
VTWRB12X32	615
VTWSN12X32	616
WPTBSILCAP	616
XI0025	511
XI0026	511
XI0051	511
XI0052	512
XI0053	512
XI0055	511
XI0059	512
XI0079	512
XI0080	512
Y00019	257
Y00021	257
Y00022	257
Y00023	258
Y00024	258
Y00025	258
Y00027	258
Y00070	481
Y00077	454