

BIOL@GIX®

CRYO  
KING

ХИММЕД

**Manufacturer**  
and **Supplier** of  
**Laboratory** Products

V.2022

Biologix Group Limited



# Biologix Group Ltd

Biologix is specialized in the R & D and production of disposable medical detection reagents & supplies, laboratory supplies & instruments, and complete biobanking solutions. Biologix has a responsible and flexible team of major technological and managerial talents in the field of life science and medicine. Biologix is rated as a High-Tech Enterprise. Taking “Serve Human Health” as the object, Biologix’s two brands: BIOLOGIX and CryoKING enjoys international excellence and reputation from the power of the sustainable innovation and continuous improvement.

Biologix focuses on the R & D and innovation of core products, and has the standard class 100,000 clean room which are compliant with GMP standards and number of professional R & D testing laboratories which are all ISO 9001, CE, and FDA registered, and follow the strict CDC guidelines for purity and efficiency. Biologix is committed to the design and manufacture of high-quality products, enriching product lines, and strengthening the service of complete solutions.

Biologix has developed a focus on constant innovation and improvement to offer optimal products, innovative solutions, and service to about dozens of countries and regions in Europe, America, and Asia. Biologix has been an international and well-known company in the world. Biologix wishes to strengthen the cooperation with international companies in OEM service and technical cooperation hand in hand to contribute to human health.

# Ordering and Services

## Private Labeling

Biologix offers a Private Labeling Program, providing high quality, branded lab supplies at very competitive prices. Many Biologix products are currently private labeled and sold worldwide by some of the most prominent brands and distributors.

## OEM Services

Biologix also operates as an OEM provider for plastic laboratory consumables. With through our in-house molding and tooling capabilities, we can provide the exact products needed by our customers at significantly lower costs than other companies can achieve. Biologix currently supplies some of the world's top distributors with its OEM products.

## Ordering Information

### A. Free Product Samples

Let us send you a FREE sample package of our great products. Contact us today if you are interested in trying out Biologix products before you buy.

### B. Distribution

If interested in distribution opportunities, please contact us for distributor terms and pricing. We are accepting distribution opportunities worldwide. Please contact us at [Inquiry@BiologixGroup.com](mailto:Inquiry@BiologixGroup.com).

## Guaranteed Quality

## Exceptional Service

## Professional Design

## Logical Pricing

## Certifications



CE



ISO



FDA

# Contents

## General Laboratory Supplies

Centrifuge Tubes	07
Microcentrifuge Tubes	08
Centrifuge Tube Racks	09
Pipet Tips	10
Filter Tips	11,12
Rainin LTS Pipette Tips	19
Automation Tips	20
Transfer Pipets	21
Solution Basins	22
Beakers	23
Reagent Bottles	24
Test Tubes	25
Slide Storage Boxes	26
Deep Well Plates	27
Sealing Films	28
Gloves	29

## CryoKING Biobanking

Screw Cap Microtubes	31
Cryogenic Vials	32
Traditional Cryogenic Vials	33
CryoKING Cryogenic Vials	34
CryoKING Combo	35
Automated Product Series of SBS Standards	36,37
Premium Cardboard Cryogenic Boxes	38
ID-Color™ Cardboard Cryogenic Boxes	39
PC Cryogenic Boxes	40
PP Cryogenic Boxes	41
Freezer Racks	42, 43
Screw Cap Capper/Decapper&Scanners	44
Tube Handling System	45
Biobanking Management Software	46
low Temperature Freezers	47
Liquid Nitrogen Tanks	48

## Cell Culture Series

Cell Culture Flasks	50
Cell Culture Dishes	51

Cell Culture Plates	52
Serological Pipettes	53
Cell Culture Slides	54
Cell Strainers	55
Sterile Syringe Filters & Vacuum Units	56
Cell Scrapers & Lifters	57

## PCR

PCR Tubes	59
8-Strip PCR Tubes	60
PCR Plates	61,62

## Microbiology

Petri Dishes	64
Inoculating Loops & Needles	65
Cell Spreaders	66

## Drosophila

Drosophila Vials	68
Drosophila Bottles	69
Drosophila Plugs	70

## Sample Collection and Detection Products

Sample Collection and Detection Products	71
---	----

## Instruments

Liquid Handling	73,74
Collection System	75
Stirrers	76
Mixers & Rotators	77
Shakers	78
Thermocyclers	79
Centrifuges	80,81,82
Dry Bath Incubators	83,84,85
Electrophoresis	86
BluView Transilluminator	87,88



# Catalog Number Index

Cat #	Page#	Cat #	Page#	Cat #	Page#	Cat #	Page#
01-110X	77	02-3024	27	07-3060	51	20-1250	10
01-120X	77	02-6022	27	07-3100	51	20-1251	10
01-130X	77	02-7022	27	07-3150	51	21-0010	10
01-2101	73	02-8005	27	07-5001	53	21-0200	10
01-2102	73	02-9010	27	07-5002	53	21-1000	10
01-2104	73	03-1300	86	07-5005	53	21-1250	10
01-2110	73	03-2310	86	07-5010	53	23-0010	11
01-2115	73	03-3070	86	07-5025	53	23-0011	11
01-2112	73	03-3100	86	07-5050	53	23-0200	11
01-2122	73	03-4221	84	07-6006	52	23-0201	11
01-2155	73	03-4222	84	07-6012	52	23-1000	11
01-220X	74	03-6210	87	07-6024	52	23-1001	11
01-221X	74	04-0008U	24	07-6048	52	23-0010S	12
01-241X	73	04-0015U	24	07-6096	52	23-0011S	12
01-242X	73	04-0030U	24	07-8025	50	23-0021S	12
01-243X	73	04-0060U	24	07-8075	50	23-0051S	12
01-244X	73	04-0125U	24	07-8175	50	23-0101S	12
01-270X	75	04-0250U	24	07-9025	50	23-0200S	12
01-2801	75	04-0500U	24	07-9075	50	23-0201S	12
01-2805	73	04-0100U	24	07-9175	50	23-1001S	12
01-2830	73	04-1008U	24	08-PES1322R	56	25-0051	20
01-310X	76	04-1015U	24	08-PES2522R	56	25-0052	20
01-320X	76	04-1030U	24	08-PES3022R	56	25-1025	20
01-320X	76	04-1060U	24	08-PES3322S	56	25-1100	20
01-330X	76	04-1125U	24	08-PES3345S	56	25-1202	20
01-330XA	76	04-1250U	24	08-PES3322M	56	30-0135	21
01-420X	88	04-1500U	24	08-PES3345M	56	30-0135A1	21
01-621XA	78	04-1100U	24	08-CA3022R	56	30-0138	21
01-700X	79	04-2008	24	08-CA3045R	56	30-0138A1	21
01-710X	79	04-2015	24	09-PES2250	56	30-0238A1	21
01-800X	80	04-2030	24	09-PES2250F	56	41-5025	26
01-821X	80	04-2060	24	09-CA2250	56	41-5100	26
01-830X	81	04-2100	24	09-CA2250F	56	41-6025	26
01-832X	81	04-2125	24	10-0151	07	41-6100	26
01-860X	82	04-2250	24	10-0152	07	51-0500	68
01-870X	82	04-2500	24	10-0501	07	51-0501	68
01-900X	85	04-3008	24	10-0502	07	51-0505	70
01-9A0X	85	04-3015	24	10-0815	07	51-0800	68
01-910X	83	04-3030	24	10-0850	07	51-0801	68
01-920X	83	04-3060	24	10-9151	07	51-0805	70
01-930X	84	04-3100	24	10-9152	07	51-17720	69
01-950X	85	04-3125	24	10-9501	07	51-17721	69
01-960X	85	04-3250	24	10-9502	07	51-17725	70
01-970X	85	04-3500	24	10-9815	07	60-0002	59
01-980X	85	05-2720	75	10-9850	07	60-0008	60
01-990X	85	05-2721	75	12-1275	25	60-0056	61
02-0008	27	05-2791	75	12-1299	25	60-0082	59
02-0096	27	05-2792	75	12-1300	25	60-0088	60
02-1016	27	05-2793	75	12-1399	25	60-0102	59
02-1022	27	05-2797	75	12-2275	25	60-0108	60
02-1096	27	05-2798	75	15-1040	55	60-0156	61
02-1196	27	07-2101	54	15-1070	55	60-0182	59
02-2010-50	27	07-2102	54	15-1100	55	60-0188	60
02-2196	27	07-2104	54	20-0010	10	60-0202	59
02-2296	27	07-2108	54	20-0200	10	60-0208	60
		07-3035	51	20-1000	10	60-0256	61

# Catalog Number Index

Cat #	Page#	Cat #	Page#	Cat #	Page#	Cat #	Page#
60-0282	59	81-0056	31	89-910X	35	97-6115	29
60-0288	60	81-0153	31	89-915X	35	98-0113	40
60-0302	59	81-0154	31	89-920X	35	98-0200	40
60-0308	60	81-0203	31	89-921X	35	98-0213	40
60-0356	61	81-0204	31	89-922X	35	98-0313	40
60-0382	59	81-0205	31	89-923X	35	98-1213	40
60-0388	60	81-7053	32	89-950X	35	98-4127	36
60-0402	59	81-7054	32	90-1200	38	98-4227	36
60-0408	60	81-7055	32	90-1281	38	98-5227	37
60-0456	61	81-7056	32	90-1536	09	99-2215	42
60-0482	59	81-7153	32	90-1550	09	99-2216	42
60-0488	60	81-7154	32	90-2200	38	99-2220	42
61-0010	28	81-7203	32	90-2281	38	99-2224	42
61-0020	28	81-7204	32	90-2300	38	99-2225	42
61-0040	28	81-7205	32	90-2381	38	99-2230	42
61-0041	28	81-8204	32	90-5016	09	99-5216	43
61-0051	28	88-005X	34	90-5025	09	99-5220	43
61-0060	28	88-010X	34	90-5200	38	99-5224	43
61-0080	28	88-015X	34	90-5281	38	99-5225	43
61-0120	28	88-020X	34	90-8009	09	99-62XX	43
61-0152	28	88-021X	34	90-8100	39	99-7216	42
61-0210	28	88-050X	34	90-8200	39	99-7220	42
61-0303	28	88-321X	33	90-8281	39	99-7224	42
61-0304	28	88-320X	33	90-8381	39	CKS-1008	44
65-0001	65	88-350X	33	90-9009	39	CKS-1520	45
65-0002	65	88-320XS	33	90-9025	41	CKS-152X	45
65-0010	65	88-350XS	33	90-9081	41	CKS-0101	44
65-1001	66	88-403X	36	90-9100	41	CKS-1301	44
65-1010	66	88-405X	36	90-9200	41	AB23-0020S	20
66-1501	64	88-408X	36	90-9210	40	AB23-0050S	20
66-1515	64	88-410X	36	90-9250	40	AB23-0250S	20
66-1560	64	88-514X	37	90-9381	40	AT23-0020S	20
66-1701	64	88-600X	33	93-0050	23	AT23-0020CS	20
70-1180	57	88-605X	34	93-0100	23	AT23-0050S	20
70-1250	57	88-610X	34	93-0250	23	AT23-0050CS	20
70-2180	57	88-615X	34	93-0400	23	AT23-0200S	20
7101	26	88-620X	33	93-0800	23	AT23-0200CS	20
7105	26	88-620XS	33	93-1000	23	AT23-1000S	20
80-0015	08	88-621X	33	96-2216	42	AT23-1000CS	20
80-0020	08	88-650X	33	96-2220	42	AH23-0050S	20
80-0500	08	88-650XS	33	96-2224	42	AH23-0050CS	20
80-1500	08	88-720X	34	96-62XX	43	AH23-0300S	20
80-1500-S	08	88-721X	34	96-5216	43	AH23-0300CS	20
80-1501	08	88-750X	34	96-5220	43	AH23-1000S	20
80-1502	08	88-905X	34	96-7216	42	AH23-1000CS	20
80-1503	08	88-910X	34	96-7220	42	AA21-0030S	20
81-0000	31	88-915X	34	96-7224	42	AA23-0250S	20
81-0001	31	88-920X	34	97-1111	29	R23-0020	19
81-0002	31	88-921X	34	97-1112	29	R23-0021	19
81-0003	31	88-950X	34	97-1113	29	R23-0200	19
81-0004	31	89-423X	36	97-1114	29	R23-0201	19
81-0005	31	89-425X	36	97-1115	29	R23-1000	19
81-0006	31	89-428X	36	97-6111	29	R23-1001	19
81-0053	31	89-421X	36	97-6112	29		
81-0054	31	89-514X	37	97-6113	29		
81-0055	31	89-905X	35	97-6114	29		

# General Laboratory Supplies

---

The General Laboratory Supplies section includes many consumables commonly used in basic laboratory and medical procedures. From centrifuge tubes and test tubes to disposable gloves and microscope slides, many of these general laboratory supplies may have applications in multiple life science fields.

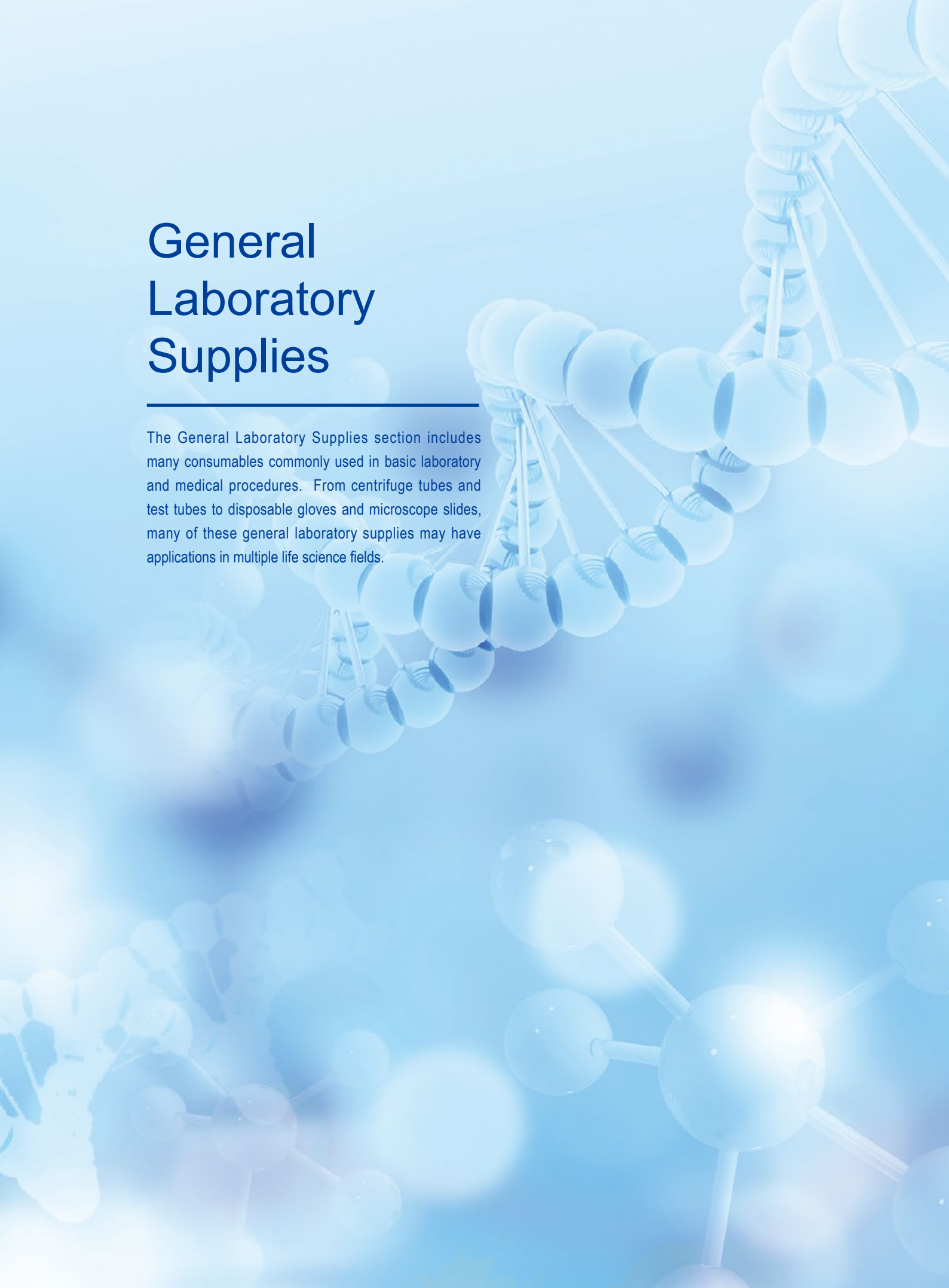



## >> Features

- Tubes: made of strong, highly transparent medical grade polypropylene
- Flat-top caps: made of medical grade polyethylene
- Plug-seal screw on caps: made of medical grade polypropylene
- 15ml and 50ml conical tubes available;
- Large white writing area for easy marking
- Double threaded design reduces cross-threading; caps are easily opened and closed
- Flat-top caps can be written on
- Gamma radiation sterilized, non-pyrogenic, RNase&DNase free
- Available in racked package (sterile) or bulk package (sterile & non-sterile)

## Specifications

- Working temperature: stable from -20°C to 121°C (except flat-top cap)
- 15ml and 50ml tubes can withstand centrifugation of 8,400 and 9,400 G respectively
- Sealing test: complies with the International Air Transport Association (IATA) Safety Standards

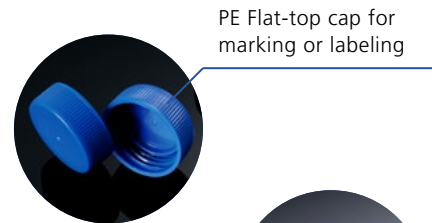

PE Flat-top cap for marking or labeling

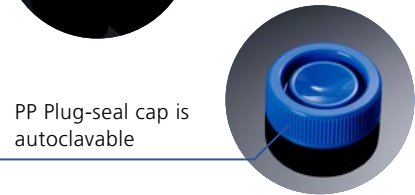

PP Plug-seal cap is autoclavable



Black graduation marks

Cat #	Volume	Caps	Sterile	Package	Unit	Total
10-9151	15ml	Flat Top	Yes	Rack	50 /Rack, 10 Racks /Case	500 /Case
10-9152	15ml	Flat Top	Yes	Bulk	25 /Bag, 20 Bags /Case	500 /Case
10-9501	50ml	Flat Top	Yes	Rack	25 /Rack, 20 Racks /Case	500 /Case
10-9502	50ml	Flat Top	Yes	Bulk	25 /Bag, 20 Bags /Case	500 /Case
10-9815	15ml	Flat Top	No	Bulk	500 /Case	500 /Case
10-9850	50ml	Flat Top	No	Bulk	500 /Case	500 /Case
10-0151	15ml	Plug Seal	Yes	Rack	50 /Rack, 10 Racks /Case	500 /Case
10-0152	15ml	Plug Seal	Yes	Bulk	25 /Bag, 20 Bags /Case	500 /Case
10-0501	50ml	Plug Seal	Yes	Rack	25 /Rack, 20 Racks /Case	500 /Case
10-0502	50ml	Plug Seal	Yes	Bulk	25 /Bag, 20 Bags /Case	500 /Case
10-0815	15ml	Plug Seal	No	Bulk	500 /Case	500 /Case
10-0850	50ml	Plug Seal	No	Bulk	500 /Case	500 /Case

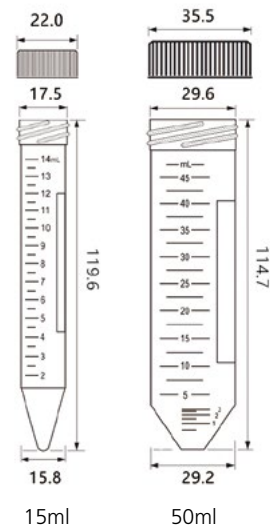

Dimensions = mm

# Microcentrifuge Tubes



## >> Features

- Made of high quality medical grade polypropylene
- Transparent tube walls permit easy viewing of contents
- Beveled lip for convenient one-handed operation
- Writing area and attached flat cap for labeling

## Specifications

- Working temperature: stable from -20°C to 121°C
- Can withstand high speed centrifugation of 20,000 G



80-0015

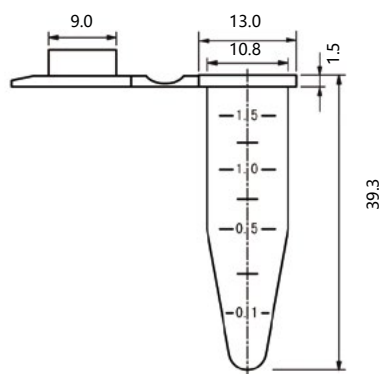

Dimensions = mm

Cat #	Volume	Color	Sterile	RNase & DNase free	Unit	Total
80-0500	0.5ml	Clear	No	Yes	500 /Bag/Pack, 10 Packs/Case	5000 /Case
80-0015	1.5ml	Clear	No	Yes	500 /Bag/Pack, 10 Packs/Case	5000 /Case
80-1500	1.5ml	Clear	No	Yes	500 /Bag/Pack, 10 Packs/Case	5000 /Case
80-1500-S	1.5ml	Clear	Yes	Yes	500 /Bag/Pack, 10 Packs/Case	5000 /Case
80-0020	2.0ml	Clear	No	Yes	500 /Bag/Pack, 10 Packs/Case	5000 /Case
80-1501*	1.5ml	Red	No	Yes	500 /Bag/Pack, 10 Packs/Case	5000 /Case
80-1502*	1.5ml	Yellow	No	Yes	500 /Bag/Pack, 10 Packs/Case	5000 /Case
80-1503*	1.5ml	Blue	No	Yes	500 /Bag/Pack, 10 Packs/Case	5000 /Case

\* Call for details



# Centrifuge Tube Racks

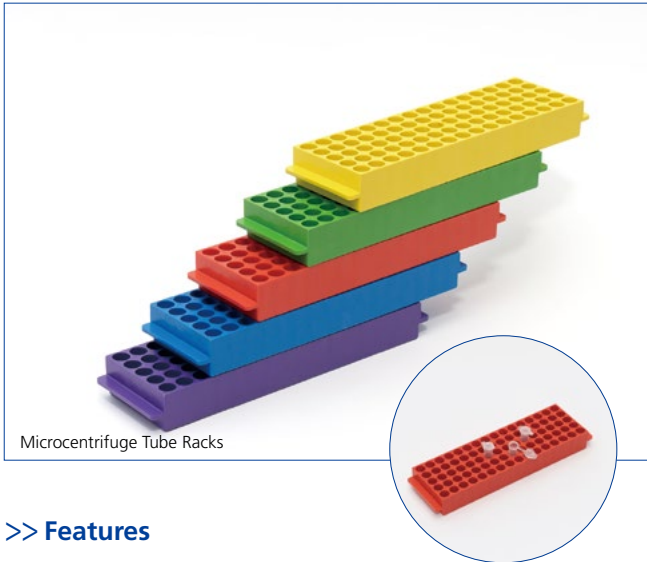

## >> Features

### Microcentrifuge Tube Racks

- Made of high strength plastic, chemically resistant to alcohols and mild organic solvents
- Writing area on side of rack for easy marking
- Handles on each end for secure handling
- 5×16 array, 80 wells, molded with a numeric grid for easy tube identification
- Fit for 1.5ml, 2.0ml microcentrifuge tubes and screw cap tubes

### PP Centrifuge Tube Racks

- Made of high quality medical grade polypropylene
- 50-well racks hold 15ml centrifuge tubes
- 25-well racks hold 50ml centrifuge tubes
- Sturdy design keeps tubes upright

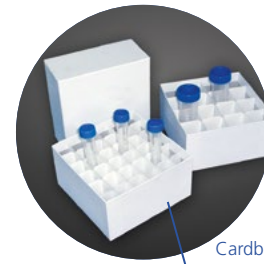

Cardboard Centrifuge Tube Rack  
Working temperature:  
from -196 °C to 121°C

### Cardboard Centrifuge Tube Racks

- Made of durable cardboard with superior white coating, chemically resistant to alcohols and mild organic solvents
- 36-well racks for 15ml centrifuge tubes, 16-well racks for 50ml centrifuge tubes
- Removable lid features a lined writing area

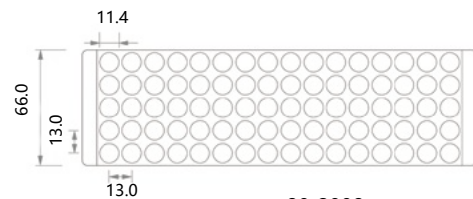
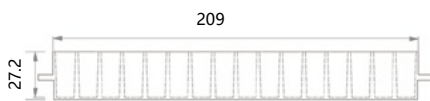

90-8009

Dimensions = mm

Cat #	Well	Color	Sterile	Unit	Total
90-8009	80-well	Assorted Colors	No	5 /Bag, 4 Bags/Case	20 /Case
90-1536	36-well	White	No	5 /Bag, 20 Bags/Case	100 /Case
90-5016	16-well	White	No	5 /Bag, 20 Bags/Case	100 /Case
90-1550	50-well	Blue	No	1 /Bag, 20 Bags/Case	20 /Case
90-5025	25-well	Blue	No	1 /Bag, 20 Bags/Case	20 /Case

# Pipet Tips



## >> Features

- Made of polypropylene, autoclavable
- Available in 10µl, 200µl and 1000µl sizes, suitable for standard manual and electronic pipettes
- 10µl and 200µl tips are graduated, 200µl tips have a beveled point design that reduces sample retention  
Extended 1000µl tips facilitate pipetting from deep or narrow containers
- RNase & DNase free, non-pyrogenic
- Available in racked package (sterile) and bulk package (non-sterile)

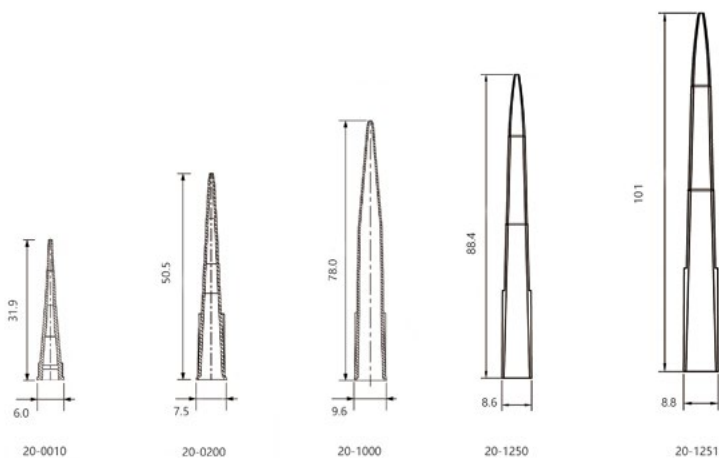

Dimensions = mm

Cat #	Volume	Color	Sterile	Unit	Total
20-0010	10µl	Natural	No	1,000 /Bag, 2 Bags /Pack, 5 Packs/Case	10000 /Case
21-0010	10µl	Natural	Yes	96 /Rack, 10 Racks/Pack, 10 Packs/Case	9600 /Case
20-0200	200µl	Yellow	No	1,000 /Bag/Pack, 10 Packs/Case	10000 /Case
21-0200	200µl	Yellow	Yes	96 /Rack, 10 Racks/Pack, 10 Packs/Case	9600 /Case
20-1000	1000µl	Blue	No	1,000 /Bag/Pack, 10 Packs/Case	10000 /Case
21-1000	1000µl	Blue	Yes	100 /Rack, 6 Racks/Pack, 10 Packs/Case	6000 /Case
20-1250	1000µl Extended	Natural	No	1,000 /Bag/Pack, 10 Packs/Case	10000 /Case
21-1250	1000µl Extended	Natural	Yes	96 /Rack, 6 Racks/Pack, 10 Packs/Case	5760 /Case
20-1251	1000µl Extra-Long	Blue	No	1,000 /Bag/Pack, 10 Packs/Case	10000 /Case





## >> Features

- Tips are made of medical grade polypropylene, and filters are made of highly hydrophobic UHMWPE
- Filters prevent cross-contamination and damage to samples, ensure accurate and precise sample aspiration, and protect the user by preventing sample liquid or vapor from entering the pipette body
- Standard filter tips and low retention filter tips available in all sizes
- Low retention treated tips undergo a coating-free treatment and will not contaminate samples
- All filter tips are autoclavable
- Available in racked package (sterile) and bulk package (non-sterile)
- RNase & DNase free, non-pyrogenic

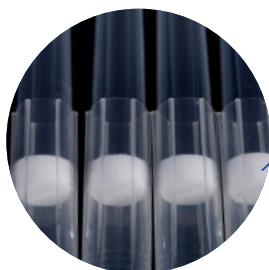

Small and uniform filter pore size ensures the accuracy and precision of sample aspiration

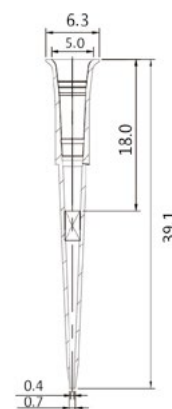

10µl Dimensions=mm

Cat #	Volume	Color	Sterile	Low Retention	Unit	Total
22-0010	10µl	Natural	No	No	1,000 /Bag, 2 Bags/Pack, 5 Packs /Case	10000 /Case
22-0011	10µl	Natural	No	Yes	1,000 /Bag, 2 Bags/Pack, 5 Packs /Case	10000 /Case
23-0010	10µl	Natural	Yes	No	96 /Rack, 10 Racks/Pack, 10 Packs/Case	9600 /Case
23-0011	10µl	Natural	Yes	Yes	96 /Rack, 10 Racks/Pack, 10 Packs/Case	9600 /Case
22-0200	200µl	Natural	No	No	1,000 /Bag/Pack, 10 Packs /Case	10000 /Case
22-0201	200µl	Natural	No	Yes	1,000 /Bag/Pack, 10 Packs /Case	10000 /Case
23-0200	200µl	Natural	Yes	No	96 /Rack, 10 Racks/Pack, 10 Packs/Case	9600 /Case
23-0201	200µl	Natural	Yes	Yes	96 /Rack, 10 Racks/Pack, 10 Packs/Case	9600 /Case
22-1000	1000µl	Natural	No	No	1,000 /Bag/Pack, 10 Packs /Case	10000 /Case
22-1001	1000µl	Natural	No	Yes	1,000 /Bag/Pack, 10 Packs /Case	10000 /Case
23-1000	1000µl	Natural	Yes	No	96 /Rack, 6 Racks/Pack, 10 Packs/Case	5760 /Case
23-1001	1000µl	Natural	Yes	Yes	96 /Rack, 6 Racks/Pack, 10 Packs/Case	5760 /Case

# Filter Tips-S Series



## >> Features

- Made in Bioclean room
- Extremely straight low retention tips ensure accurate and precise sample
- Extra-long tips: 10µl with max volume 20µl, 200µl with max volume 300µl, and 1000µl with max volume 1250µl
- Racked filter tips, sterile
- DNase & RNase free, non-pyrogenic

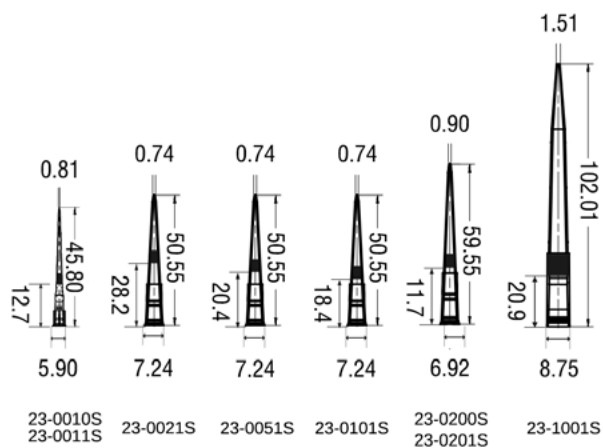

Dimensions = mm



Cat #	Volume	Color	Sterile	Unit	Total
23-0010S	10µl Extended	Natural	Yes	96 Pieces/Rack, 50 Racks/Case	4800 /Case
23-0011S	10µl Extended	Natural	Yes	96 Pieces/Rack, 50 Racks/Case	4800 /Case
23-0021S	20µl	Natural	Yes	96 Pieces/Rack, 50 Racks/Case	4800 /Case
23-0051S	50µl	Natural	Yes	96 Pieces/Rack, 50 Racks/Case	4800 /Case
23-0101S	100µl	Natural	Yes	96 Pieces/Rack, 50 Racks/Case	4800 /Case
23-0200S	200µl Extended	Natural	Yes	96 Pieces/Rack, 50 Racks/Case	4800 /Case
23-0201S	200µl Extended	Natural	Yes	96 Pieces/Rack, 50 Racks/Case	4800 /Case
23-1001S	1000µl Extended	Natural	Yes	96 Pieces/Rack, 50 Racks/Case	4800 /Case

# Pipet Tip Compatibility

Pipettor Brand/Make	Volume Range	0.5-10µl	20-0010	0.5-10µl	21-0010	1-200µl	20-0200	1-200µl	21-0200	100-1000µl	20-1000	100-1000µl	21-1000	100-1000µl	20-1250	100-1000µl	20-1251	0.5-10µl	21-1250	0.5-10µl	22-0010	0.5-10µl	22-0011	0.5-10µl	23-0010	1-200µl	23-0011	1-200µl	22-0200	1-200µl	22-0201	1-200µl	23-0200	1-200µl	23-0201	100-1000µl	22-1000	100-1000µl	22-1001	100-1000µl	23-1000	100-1000µl	23-1001						
Axygen Axytip (single channel)	0.1-2µl	✓	✓															✓	✓	✓	✓																												
	0.5-10µl	✓	✓															✓	✓	✓	✓																												
	2-20µl			✓	✓																																												
	5-50µl			✓	✓																																												
	10-100µl			✓	✓																																												
	20-200µl			✓	✓																					✓	✓	✓	✓																				
	50-250µl																																																
100-1000µl																																																	
Axygen Axytip (multichannel)	1-10µl	✓	✓															✓	✓	✓	✓																												
	5-50µl			✓	✓																																												
	20-200µl			✓	✓																				✓	✓	✓	✓																					
	50-300µl			✓	✓																																												
Axygen Axytip-16	0.2-2µl																																																
	0.5-10µl																																																
	5-50µl																																																
Biohit Proline (single channel)	0.2-10µl	✓	✓															✓	✓	✓	✓																												
	5-100µl			✓	✓																																												
	10-250µl			✓	✓																				✓	✓	✓	✓																					
	10-500µl					✓	✓	✓	✓	✓																																							
	50-1000µl					✓	✓	✓	✓	✓																																							
Biohit Proline (multichannel)	0.2-10µl	✓	✓															✓	✓	✓	✓																												
	5-100µl			✓	✓																					✓	✓	✓	✓																				
	25-250µl			✓	✓																					✓	✓	✓	✓																				
Biohit e-Line (single channel)	1-10µl	✓	✓															✓	✓	✓	✓																												
	5-120µl			✓	✓																																												
	10-300µl			✓	✓																																												
	50-1000µl					✓	✓	✓	✓	✓																																							
Biohit e-Line (multichannel)	0.2-10µl	✓	✓															✓	✓	✓	✓																												
	5-120µl			✓	✓																																												
	10-300µl			✓	✓																																												
Biohit m-Line (single channel)	0.5-10µl																																																
	2-20µl			✓	✓																																												
	10-100µl			✓	✓																																												

# Pipet Tip Compatibility

	0.5-10µl	0.5-10µl	1-200µl	1-200µl	100-1000µl	100-1000µl	100-1000µl	100-1000µl	100-1000µl	100-1000µl	0.5-10µl	0.5-10µl	0.5-10µl	0.5-10µl	1-200µl	1-200µl	1-200µl	1-200µl	100-1000µl	100-1000µl	100-1000µl	100-1000µl	Volume/Biologix Tip	Volume Range	Pipettor Brand/Make
			✓	✓											✓	✓	✓	✓					20-200µl	Biohit m-Line (multichannel)	
					✓	✓	✓	✓											✓	✓	✓		100-1000µl		
✓	✓									✓	✓	✓	✓										0.5-10µl		
		✓	✓												✓	✓	✓	✓					5-100µl		
		✓	✓												✓	✓	✓	✓					30-300µl		
✓	✓									✓	✓	✓	✓										0.2-2µl	Capp Aero (multichannel)	
✓	✓									✓	✓	✓	✓										0.5-10µl		
		✓	✓																				5-50µl		
		✓	✓												✓	✓	✓	✓					10-100µl		
		✓	✓												✓	✓	✓	✓					25-200µl		
				✓	✓	✓	✓	✓							✓	✓	✓	✓					50-300µl		
				✓	✓	✓	✓	✓											✓	✓	✓		100-1000µl		
																							0.2-2µl	384 Format (multichannel)	
																							0.5-10µl		
																							5-50µl		
✓	✓									✓	✓	✓	✓										0.1-1µl	BrandTech Transferpette (single channel)	
✓	✓									✓	✓	✓	✓										0.5-10µl		
		✓	✓																				2-20µl		
		✓	✓																				2-20µl		
		✓	✓																				5-50µl		
		✓	✓												✓	✓	✓	✓					10-100µl		
		✓	✓												✓	✓	✓	✓					20-200µl		
		✓	✓												✓	✓	✓	✓					25-250µl		
				✓	✓	✓	✓	✓											✓	✓	✓		100-1000µl		
✓	✓									✓	✓	✓	✓										0.5-10µl	BrandTech Transferpette (multichannel)	
		✓	✓																				2-20µl		
		✓	✓																				2.5-25µl		
		✓	✓																				5-50µl		
		✓	✓																				10-100µl		
		✓	✓																				20-200µl		
		✓	✓																				30-300µl		
✓	✓									✓	✓	✓	✓										0.5-10µl	Eppendorf Electronic	
		✓	✓																				5-100µl		
		✓	✓											✓	✓	✓	✓						2-200µl		
				✓	✓	✓	✓	✓											✓	✓	✓		50-1000µl		

# Pipet Tip Compatibility

Pipettor Brand/Make Volume Range	Volume/Biologix Tip																																												
	0.5-10µl	20-0010	0.5-10µl	21-0010	1-200µl	20-0200	1-200µl	21-0200	100-1000µl	20-1000	100-1000µl	21-1000	100-1000µl	20-1250	100-1000µl	20-1251	0.5-10µl	21-1250	0.5-10µl	22-0010	0.5-10µl	22-0011	0.5-10µl	23-0010	1-200µl	23-0011	1-200µl	22-0200	1-200µl	23-0201	1-200µl	23-0200	100-1000µl	23-0201	100-1000µl	22-1000	100-1000µl	22-1001	100-1000µl	23-1000	100-1000µl	23-1001			
Labnet Labpette (single channel)	0.1-2µl	✓	✓													✓	✓	✓	✓																										
	0.5-10µl	✓	✓														✓	✓	✓	✓																									
	2-20µl				✓	✓																																							
	10-100µl				✓	✓																																							
	20-200µl				✓	✓																				✓	✓	✓	✓																
Labnet Labpette (multichannel)	1-10µl	✓	✓														✓	✓	✓	✓																									
	5-50µl				✓	✓																																							
	20-200µl				✓	✓																				✓	✓	✓	✓																
	50-300µl				✓	✓																				✓	✓	✓	✓																
Labnet BioPette E (single channel)	0.5-10µl	✓	✓														✓	✓	✓	✓																									
	2-20µl	✓	✓														✓	✓	✓	✓																									
	10-200µl				✓	✓																				✓	✓	✓	✓																
	100-1000µl							✓	✓	✓	✓	✓																											✓	✓	✓				
Labnet BioPette E (multichannel)	0.5-10µl	✓	✓														✓	✓	✓	✓																									
	2-20µl	✓	✓														✓	✓	✓	✓																									
	10-200µl				✓	✓																				✓	✓	✓	✓																
	100-1000µl							✓	✓	✓	✓	✓																												✓	✓	✓			
MatrixImpact/ Impact <sup>s</sup> (s/mc)	2-125µl				✓	✓																																							
	5-250µl																									✓	✓	✓	✓																
	15-1250µl													✓	✓	✓																							✓	✓	✓				
Nichiryo/Oxford Benchmate	0.5-10µl	✓	✓														✓	✓	✓	✓																									
	2-20µl				✓	✓																																							
	10-50µl				✓	✓																																							
	10-100µl																																												
	40-200µl																																												
	100-1000µl																																												
Rainin EDP3 (single channel)	E-MIC-10,0.5-10µl	✓	✓														✓	✓	✓	✓																									
	E2-25,2.5-25µl				✓	✓																																							
	E2-100,10-100µl				✓	✓																																							
	E2-250,25-250µl				✓	✓																				✓	✓	✓	✓																
E2-1000,100-1000µl							✓	✓	✓	✓	✓																												✓	✓	✓				

# Pipet Tip Compatibility

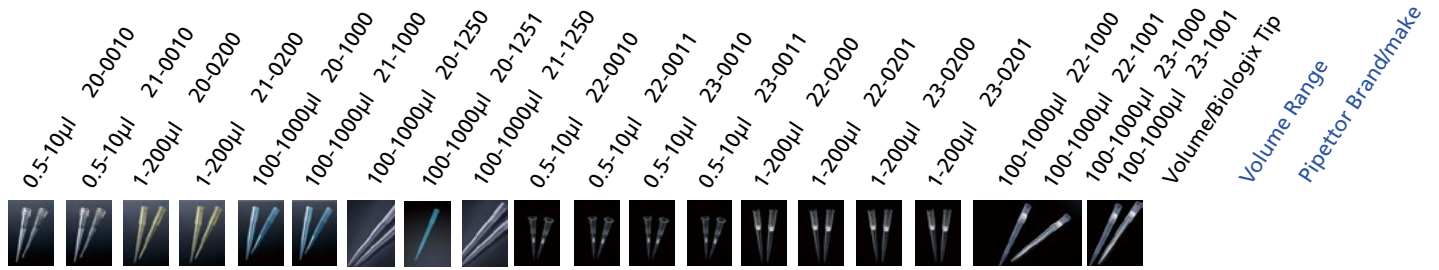

0.5-10µl	0.5-10µl 20-0010	1-200µl 21-0010	1-200µl 20-0200	100-1000µl 21-0200	100-1000µl 20-1000	100-1000µl 21-1000	100-1000µl 20-1250	100-1000µl 20-1251	0.5-10µl 21-1250	0.5-10µl 22-0010	0.5-10µl 22-0011	0.5-10µl 23-0010	1-200µl 23-0011	1-200µl 22-0200	1-200µl 22-0201	1-200µl 23-0200	100-1000µl 23-0201	100-1000µl 22-1000	100-1000µl 22-1001	100-1000µl 23-1000	23-1001	Volume/BioLogix Tip	Volume Range	Pipettor Brand/Make	
✓	✓								✓	✓	✓	✓												0.1-10µl	Eppendorf Reference (single channel) & (multichannel)
		✓	✓																					2-20µl	
		✓	✓																					10-100µl	
		✓	✓										✓	✓	✓	✓								20-200µl	
				✓	✓	✓	✓	✓					✓	✓	✓	✓	✓	✓	✓					100-1000µl	
✓	✓								✓	✓	✓	✓												0.1-2.5µl	Eppendorf Research (single channel)
✓	✓								✓	✓	✓	✓												0.5-10µl	
		✓	✓																					2-20µl	
		✓	✓																					10-100µl	
		✓	✓											✓	✓	✓	✓							25-200µl	
				✓	✓	✓	✓	✓																100-1000µl	
✓	✓								✓	✓	✓	✓												0.5-10µl	Eppendorf Research (multichannel)
																								5-100µl	
		✓	✓																					50-100µl	
		✓	✓											✓	✓	✓	✓							20-300µl	
		✓	✓	✓	✓									✓	✓	✓	✓							30-300µl	
		✓	✓	✓	✓																			50-1200µl	
✓	✓								✓	✓	✓	✓												0.2-10µl	Thermo Scientific Finnpipette (single channel)
✓	✓								✓	✓	✓	✓												0.5-10µl	
		✓	✓																					5-40µl	
		✓	✓											✓	✓	✓	✓							40-200µl	
				✓	✓	✓	✓	✓																100-1000µl	
				✓	✓	✓	✓	✓																200-1000µl	
		✓	✓																					5-50µl	Thermo Scientific Finnpipette (multichannel)
		✓	✓											✓	✓	✓	✓							50-300µl	
✓	✓								✓	✓	✓	✓												P2, 0.1-2µl	Gilson Pipetman (single channel)
✓	✓								✓	✓	✓	✓												P10, 0.2-10µl	
		✓	✓																					P20, 2-20µl	
		✓	✓																					P100, 10-100µl	
		✓	✓											✓	✓	✓	✓							P200, 20-200µl	
				✓	✓	✓	✓	✓																P1000, 100-1000µl	
		✓	✓											✓	✓	✓	✓							P200-M8, 20-200µl (m/ch)	

# Pipet Tip Compatibility

Pipettor Brand/Make		Volume Range	0.5-10µl	0.5-10µl	1-200µl	1-200µl	100-1000µl	100-1000µl	100-1000µl	100-1000µl	100-1000µl	100-1000µl	0.5-10µl	0.5-10µl	0.5-10µl	0.5-10µl	1-200µl	1-200µl	1-200µl	1-200µl	100-1000µl	100-1000µl	100-1000µl	100-1000µl	100-1000µl	100-1000µl	100-1000µl	100-1000µl	100-1000µl			
		Volume/Biologix Tip	20-0010	21-0010	20-0200	21-0200	20-1000	21-1000	20-1250	21-1250	22-0010	22-0011	23-0010	23-0011	22-0200	22-0201	23-0200	23-0201	23-0201	23-0201	100-1000µl	100-1000µl	22-1000	22-1001	23-1000	23-1001	23-1001	23-1001	23-1001			
Rainin EDP3 (multichannel)	EP-M8-10, 0.5-10µl		✓	✓									✓	✓	✓	✓																
	EP-M8-250, 10-250µl				✓	✓											✓	✓	✓	✓												
Rainin Latch Mode	R2, 0.1-2µl		✓	✓									✓	✓	✓	✓																
	R10, 0.2-10µl		✓	✓									✓	✓	✓	✓																
	R20, 2-20µl				✓	✓																										
	R100, 10-100µl				✓	✓																										
	R200, 20-200µl				✓	✓											✓	✓	✓	✓												
	R1000, 100-1000µl						✓	✓	✓	✓	✓																✓	✓	✓			
Socorex Calibra/Accura (single channel)	0.1-2µl		✓	✓									✓	✓	✓	✓																
	0.2-2µl		✓	✓									✓	✓	✓	✓																
	0.5-10µl		✓	✓									✓	✓	✓	✓																
	1-10µl		✓	✓									✓	✓	✓	✓																
	2-20µl				✓	✓																										
	10-100µl				✓	✓																										
	20-200µl				✓	✓											✓	✓	✓	✓												
100-1000µl						✓	✓	✓	✓	✓																✓	✓	✓				
Socorex Calibra/Accura (multichannel)	1-10µl		✓	✓									✓	✓	✓	✓																
	5-50µl				✓	✓											✓	✓	✓	✓												
	10-100µl				✓	✓											✓	✓	✓	✓												
	20-200µl				✓	✓											✓	✓	✓	✓												
	50-200µl				✓	✓											✓	✓	✓	✓												
VWR and VWR Signature (single channel)	0.1-2µl		✓	✓									✓	✓	✓	✓																
	0.5-10µl		✓	✓									✓	✓	✓	✓																
	2-20µl				✓	✓																										
	5-50µl				✓	✓																										
	10-100µl				✓	✓																										
	20-200µl				✓	✓											✓	✓	✓	✓												
	50-250µl				✓	✓											✓	✓	✓	✓												
100-1000µl						✓	✓	✓	✓	✓																✓	✓	✓				
VWR and VWR Signature (multichannel)	1-10µl		✓	✓									✓	✓	✓	✓																
	5-50µl				✓	✓																										
	20-200µl				✓	✓											✓	✓	✓	✓												
	50-300µl				✓	✓											✓	✓	✓	✓												



# Pipet Tip Compatibility

Pipette Brand		Eppendorf Research Plus					Gilson Pipetman(PG)					Gilson Pipetman(PN)					Gilson Pipetman(PL)									
Model / Range		0.1-2.5ul	0.5-10ul	2-20ul	10-100ul	20-200ul	100-1000ul	P2, 0.2-2ul	P10, 1-10ul	P20, 2-20ul	P100, 10-100ul	P200, 20-200ul	P1000, 100-1000ul	P2, 0.2-2ul	P10, 1-10ul	P20, 2-20ul	P100, 10-100ul	P200, 20-200ul	P1000, 100-1000ul	P2, 0.2-2ul	P10, 1-10ul	P20, 2-20ul	P100, 10-100ul	P200, 20-200ul	P1000, 100-1000ul	
Volume	Product No.	Universal Fit Filter Tips																								
0.5-10ul	23-0010S	✓	✓					✓	✓					✓	✓					✓	✓					
	23-0011S	✓	✓					✓	✓					✓	✓					✓	✓					
1-20ul	23-0020S			✓					✓							✓						✓				
	23-0021S			✓					✓							✓						✓				
1-50ul	23-0050S				✓				✓	✓						✓	✓					✓	✓			
	23-0051S				✓				✓	✓						✓	✓					✓	✓			
1-100ul	23-0100S				✓				✓	✓						✓	✓					✓	✓			
	23-0101S				✓				✓	✓						✓	✓					✓	✓			
1-300ul	23-0200S					✓				✓						✓						✓		✓		
	23-0201S					✓				✓						✓						✓		✓		
100-1000ul	23-1000S						✓					✓					✓					✓		✓		
	23-1001S						✓					✓					✓					✓		✓		

Pipette Brand		Thermo Finnpiquette (F1)								Thermo Finnpiquette (F2)								Thermo Finnpiquette (F3)																
Model / Range		0.2-2ul	1-10ul	1-10ul(µTip)	2-20ul	2-20ul(µTip)	5-50ul	5-50ul(µTip)	10-100ul	20-200ul	30-300ul	100-1000ul	0.2-2ul(µTip)	1-10ul	1-10ul(µTip)	2-20ul	2-20ul(µTip)	5-50ul	5-50ul(µTip)	10-100ul	20-200ul	100-1000ul	0.2-2ul	1-10ul	1-10ul(µTip)	2-20ul	2-20ul(µTip)	5-50ul	5-50ul(µTip)	10-100ul	20-200ul	100-1000ul		
Volume	Product No.	Universal Fit Filter Tips																																
0.5-10ul	23-0010S	✓	✓											✓									✓	✓										
	23-0011S	✓	✓											✓									✓	✓										
1-20ul	23-0020S				✓										✓										✓									
	23-0021S				✓										✓										✓									
1-50ul	23-0050S					✓			✓	✓						✓	✓						✓	✓				✓	✓					
	23-0051S					✓			✓	✓						✓	✓						✓	✓				✓	✓					
1-100ul	23-0100S					✓			✓	✓						✓	✓						✓	✓				✓	✓					
	23-0101S					✓			✓	✓						✓	✓						✓	✓				✓	✓					
1-300ul	23-0200S										✓						✓						✓			✓			✓		✓			
	23-0201S										✓						✓						✓			✓			✓		✓			
100-1000ul	23-1000S										✓							✓					✓			✓			✓		✓			
	23-1001S										✓							✓					✓			✓			✓		✓			

Pipette Brand		BIOHIT Proline								BIOHIT Proline (Plus)								BRAND																	
Model / Range		0.1-2.5ul	0.5-10ul	2-20ul	5-50ul	10-100ul	20-200ul	50-300ul	100-1000ul	0.1-3ul	0.5-10ul	2-20ul	5-50ul	10-100ul	20-200ul	30-300ul	100-1000ul	0.1-1ul	0.1-2.5ul	0.5-10ul	2-20ul	5-50ul	10-100ul	20-200ul	30-300ul	100-1000ul	0.1-1ul	0.1-2.5ul	0.5-10ul	2-20ul	5-50ul	10-100ul	20-200ul	30-300ul	100-1000ul
Volume	Product No.	Universal Fit Filter Tips																																	
0.5-10ul	23-0010S	✓	✓								✓	✓							✓	✓					✓	✓									
	23-0011S	✓	✓								✓	✓								✓	✓					✓	✓								
1-20ul	23-0020S			✓									✓											✓											
	23-0021S			✓									✓											✓											
1-50ul	23-0050S				✓	✓	✓	✓					✓	✓	✓	✓								✓	✓			✓	✓						
	23-0051S				✓	✓	✓	✓					✓	✓	✓	✓								✓	✓			✓	✓						
1-100ul	23-0100S					✓	✓	✓					✓	✓	✓	✓								✓	✓			✓	✓						
	23-0101S					✓	✓	✓					✓	✓	✓	✓								✓	✓			✓	✓						
1-300ul	23-0200S						✓	✓						✓	✓									✓			✓		✓		✓				
	23-0201S						✓	✓						✓	✓									✓			✓		✓		✓				
100-1000ul	23-1000S								✓								✓							✓			✓		✓		✓				
	23-1001S								✓								✓							✓			✓		✓		✓				

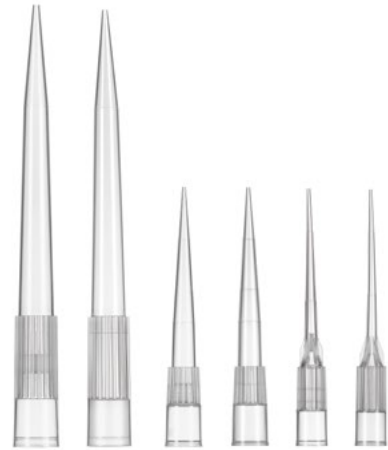
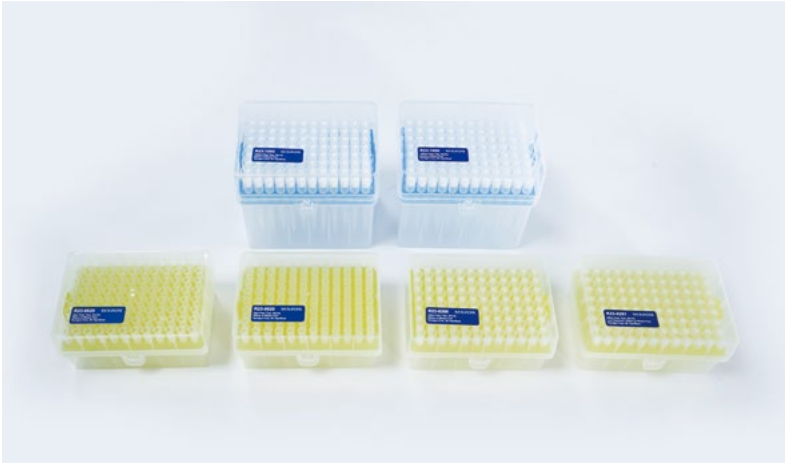

## >> Features

- Tips are made of medical grade polypropylene, and filters are made of highly hydrophobic UHMWPE
- 20µl, 200µl, and 1000µl tips
- Filters prevent cross-contamination and damage to samples, ensure accurate and precise sample aspiration, and protect the user by preventing sample liquid or vapor from entering the pipette body
- Low-retention tips undergo a coating-free treatment and will not contaminate samples.
- User-friendly labels on tip racks enable convenient usage
- DNase & RNase Free, non-pyrogen
- Sterile SAL 10<sup>-6</sup>

User-friendly labels on tip racks enable convenient usage



Cat #	Description	Unit
R23-0020	20µl tip, rack, with filter, sterile	96 Tips/Rack, 50 Racks/Case
R23-0021	20µl tip, rack, sterile, with filter, low retention	96 Tips/Rack, 50 Racks/Case
R23-0200	200µl tip, rack, with filter, sterile	96 Tips/Rack, 50 Racks/Case
R23-0201	200µl tip, rack, sterile, with filter, low retention	96 Tips/Rack, 50 Racks/Case
R23-1000	1000µl tip, rack, with filter, sterile	96 Tips/Rack, 50 Racks/Case
R23-1001	1000µl tip, rack, sterile, with filter, low retention	96 Tips/Rack, 50 Racks/Case

Non-filtered tips also available.

# Automation Tips



## >> Features

- Made of medical grade medical grade polypropylene /black conductive medical grade polypropylene
- Compatible with Beckman, Tecan, Hamilton, and Agilent workstations
- Clear/black conductive tips, filtered/non-filtered tips, sterile/non-sterile tips  
low-retention/non low-retention tips available
- DNase & RNase Free, non-pyrogen
- Electron beam sterilization, SAL 10<sup>-6</sup>



Cat #	Volume	Matched Workstations	Features	Length mm	Unit
AB23-0020S	20µl	Beckman FX/NX	Clear, filtered, sterile, green racks	Standard (38.20)	96 Tips/Rack, 10 Racks/Pack, 5 Packs/Case
AB23-0050S	50µl	Beckman FX/NX	Clear, filtered, sterile, blue racks	Standard (51.20)	96 Tips/Rack, 10 Racks/Pack, 5 Packs/Case
AB23-0250S	250µl	Beckman FX/NX	Clear, filtered, sterile, purple racks	Standard (51.20)	96 Tips/Rack, 10 Racks/Pack, 5 Packs/Case
AT23-0020S	20µl	Tecan Genesis Freedom/ Freedom Evo	Clear, filtered, sterile	Standard (35.35)	96 Tips/Rack, 24 Racks/Case
AT23-0020CS	20µl	Tecan Genesis Freedom/ Freedom Evo	Conductive, filtered, sterile	Standard (35.35)	96 Tips/Rack, 24 Racks/Case
AT23-0050S	50µl	Tecan Genesis Freedom/ Freedom Evo	Clear, filtered, sterile	Standard (58)	96 Tips/Rack, 24 Racks/Case
AT23-0050CS	50µl	Tecan Genesis Freedom/ Freedom Evo	Conductive, filtered, sterile	Standard (58)	96 Tips/Rack, 24 Racks/Case
AT23-0200S	200µl	Tecan Genesis Freedom/ Freedom Evo	Clear, filtered, sterile	Standard (58.5)	96 Tips/Rack, 24 Racks/Case
AT23-0200CS	200µl	Tecan Genesis Freedom/ Freedom Evo	Conductive, filtered, sterile	Standard (58.5)	96 Tips/Rack, 24 Racks/Case
AT23-1000S	1000µl	Tecan Genesis Freedom/ Freedom Evo	Clear, filtered, sterile	Standard (95.5)	96 Tips/Rack, 16 Racks/Case
AT23-1000CS	1000µl	Tecan Genesis Freedom/ Freedom Evo	Conductive, filtered, sterile	Standard (95.5)	96 Tips/Rack, 16 Racks/Case
AH23-0050S	50µl	Hamilton Star/Starlet/Nimbus	Clear, filtered, sterile	Standard (50.4)	96 Tips/Rack, 24 Racks/Case
AH23-0050CS	50µl	Hamilton Star/Starlet/Nimbus	Conductive, filtered, sterile	Standard (50.4)	96 Tips/Rack, 24 Racks/Case
AH23-0300S	300µl	Hamilton Star/Starlet/Nimbus	Clear, filtered, sterile	Standard (60)	96 Tips/Rack, 24 Racks/Case
AH23-0300CS	300µl	Hamilton Star/Starlet/Nimbus	Conductive, filtered, sterile	Standard (60)	96 Tips/Rack, 24 Racks/Case
AH23-1000S	1000µl	Hamilton Star/Starlet/Nimbus	Clear, filtered, sterile	Standard (95)	96 Tips/Rack, 16 Racks/Case
AH23-1000CS	1000µl	Hamilton Star/Starlet/Nimbus	Conductive, filtered, sterile	Standard (95)	96 Tips/Rack, 16 Racks/Case
AA21-0030S	30µl	Agilent	Clear, sterilized	Standard (26.04)	384 Tips/Rack, 10 Racks/Pack, 5 Packs/Case
AA23-0250S	250µl	Agilent	Clear, filtered, sterilized	Standard (55.50)	96 Tips/Rack, 10 Racks/Pack, 5 Packs/Case



## >> Features

- Polyethylene pipettes will not shatter or break
- An excellent alternative to Pasteur pipettes and rubber bulbs
- Evenly distributed thickness ensures uniform suction force
- Gamma radiation sterilized option available
- Available wrapped individually (sterile) or in bulk package (non-sterile)

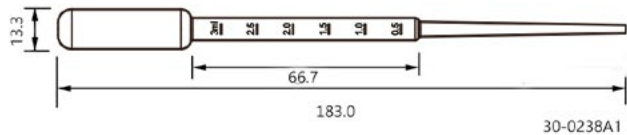
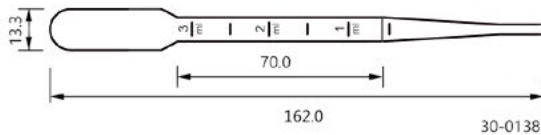
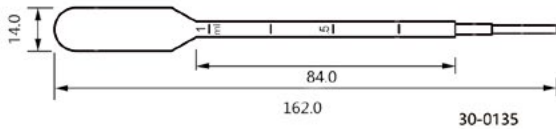
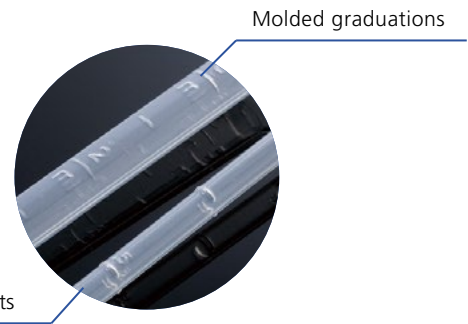

Dimensions = mm

Cat #	Length	Graduated To	Sterile	Package	Unit	Total
30-0135	162.0mm	1ml	No	Bulk	500 /Pack, 4 Packs/Case	2000 /Case
30-0135A1	162.0mm	1ml	Yes	Individually Wrapped	500 /Pack, 4 Packs/Case	2000 /Case
30-0138	162.0mm	3ml	No	Bulk	500 /Pack, 4 Packs/Case	2000 /Case
30-0138A1	162.0mm	3ml	Yes	Individually Wrapped	500 /Pack, 4 Packs/Case	2000 /Case
30-0238A1	183.0mm	3ml	Yes	Individually Wrapped	500 /Pack, 4 Packs/Case	2000 /Case

# Solution Basins



## >> Features

- Made of PVC, polystyrene (PS), or strong polypropylene (PP)
- PVC basins have transparent walls to permit easy viewing of contents
- Polypropylene basins are chemically resistant to alcohols and mild organic solvents
- PS one-channel basins are available in three sizes: 25ml, 55ml, and 100ml; 25ml and 55ml basins have a V-shaped bottom design
- PVC one-channel basins have a capacity of 55ml and a V-shaped bottom design
- PP 12-channel basins are double sided: the 12-channel side has a capacity of 5ml per channel; the other side (single-channel) has a capacity of 50ml
- PP 12-channel basins are available in assorted colors: clear, blue, green, pink, and yellow
- PS basins are individually packaged (sterile); PVC and PP basins are bulk packaged (non-sterile)

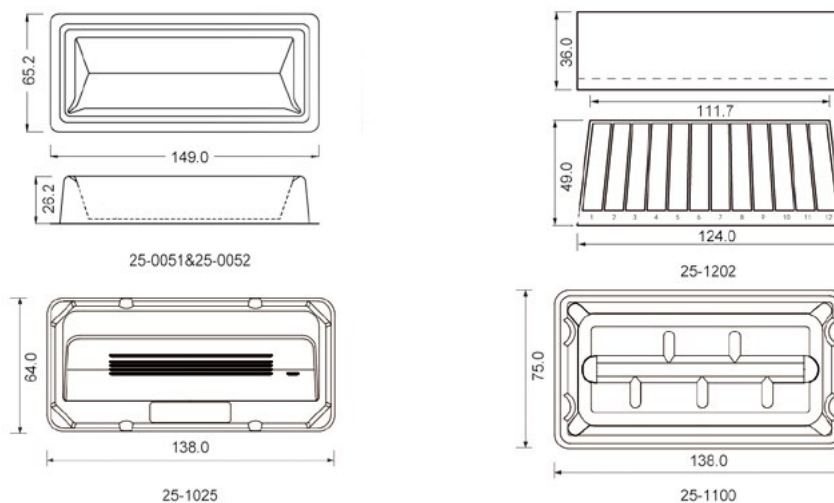

Dimensions = mm

Cat #	Volume	Material	Color	Sterile	Package	Unit	Total
25-1025	25ml	PS	White	Yes	Individually Wrapped	1 /Bag, 100 Bags/Case	100 /Case
25-1202	50ml	PP	Assorted Colors	No	Bulk	25 /Bag, 4 Bags/Case	100 /Case
25-0052	55ml	PVC	Clear	No	Bulk	100 /Bag, 8 Bags/Case	800 /Case
25-0051	55ml	PS	White	Yes	Individually Wrapped	1 /Bag, 100 Bags/Case	100 /Case
25-1100	100ml	PS	White	Yes	Individually Wrapped	1 /Bag, 50 Bags/Case	50 /Case



## >> Features

- Made of strong, medical grade polypropylene, autoclavable
- Tri-corner design provides three dripless pouring spouts
- Six different sizes meet different needs

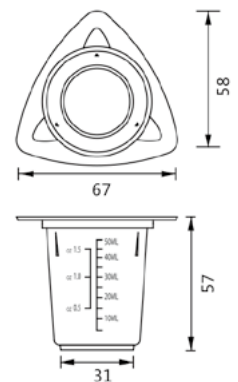
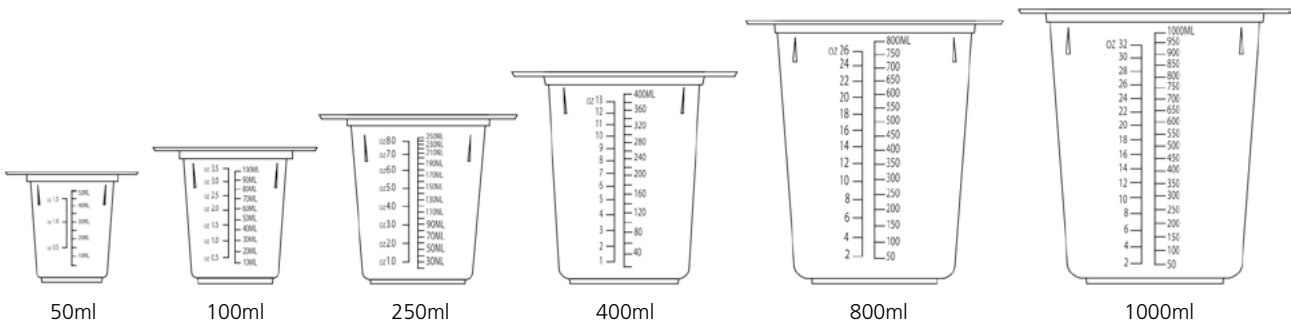

Cat #	Volume	Sterile	Unit	Total
93-0050	50ml	No	25 Pieces/Sleeve, 4 Sleeves/Case	100 /Case
93-0100	100ml	No	25 Pieces/Sleeve, 4 Sleeves/Case	100 /Case
93-0250	250ml	No	25 Pieces/Sleeve, 4 Sleeves/Case	100 /Case
93-0400	400ml	No	25 Pieces/Sleeve, 4 Sleeves/Case	100 /Case
93-0800	800ml	No	25 Pieces/Sleeve, 4 Sleeves/Case	100 /Case
93-1000	1,000ml	No	25 Pieces/Sleeve, 4 Sleeves/Case	100 /Case

Dimensions = mm



# Reagent Bottles



## >> Features

- Made of durable medical grade polypropylene or high-density polyethylene
- Uniform wall thickness and strength, impact-resistant, great chemical resistance to most acid, alkali, and alcohol
- Polypropylene bottles are autoclavable
- Wide-mouth design enables the superior sealing performance, and the convenience for filling liquid
- Lineless caps provide the ultimate in leakproof protection without the use of liner that can wrinkle, cause leaks, or contaminate your reagents
- Amber/brown bottles reduce UV light transmissions to protect light-sensitive liquids; Clear/natural bottles are convenient to observe inner items
- Various volumes are available: 8ml, 15ml, 30ml, 60ml, 125ml, 250ml, 500ml, and 1000ml
- DNase & RNase free, non-pyrogenic
- Sterile bottles also available

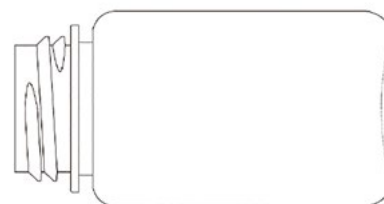

Cat #	Color	Cat #	Color	Volume	Material	Sterile	Unit
04-0008U	Clear	04-1008U	Amber	8ml	PP	No	100 /Bag, 10 Bags/Case
04-0015U	Clear	04-1015U	Amber	15ml	PP	No	100 /Bag, 10 Bags/Case
04-0030U	Clear	04-1030U	Amber	30ml	PP	No	100 /Bag, 10 Bags/Case
04-0060U	Clear	04-1060U	Amber	60ml	PP	No	50 /Bag, 10 Bags/Case
04-0125U	Clear	04-1125U	Amber	125ml	PP	No	25 /Bag, 10 Bags/Case
04-0250U	Clear	04-1250U	Amber	250ml	PP	No	20 /Bag, 10 Bags/Case
04-0500U	Clear	04-1500U	Amber	500ml	PP	No	10 /Bag, 10 Bags/Case
04-0100U	Clear	04-1100U	Amber	1000ml	PP	No	5 /Bag, 20 Bags/Case
04-2008	Natural	04-3008	Brown	8ml	Bottles: HDPE, caps: PP	No	1000 /Case
04-2015	Natural	04-3015	Brown	15ml	Bottles: HDPE, caps: PP	No	1000 /Case
04-2030	Natural	04-3030	Brown	30ml	Bottles: HDPE, caps: PP	No	400 /Case
04-2060	Natural	04-3060	Brown	60ml	Bottles: HDPE, caps: PP	No	650 /Case
04-2125	Natural	04-3125	Brown	125ml	Bottles: HDPE, caps: PP	No	350 /Case
04-2250	Natural	04-3250	Brown	250ml	Bottles: HDPE, caps: PP	No	200 /Case
04-2500	Natural	04-3500	Brown	500ml	Bottles: HDPE, caps: PP	No	100 /Case
04-2100	Natural	04-3100	Brown	1000ml	Bottles: HDPE, caps: PP	No	50 /Case





PS



PP

## >> Features

- Tubes: made of medical grade polystyrene or polypropylene
- Caps: made of medical grade polyethylene
- Tubes are available in two sizes: 12 × 75mm and 13 × 100mm

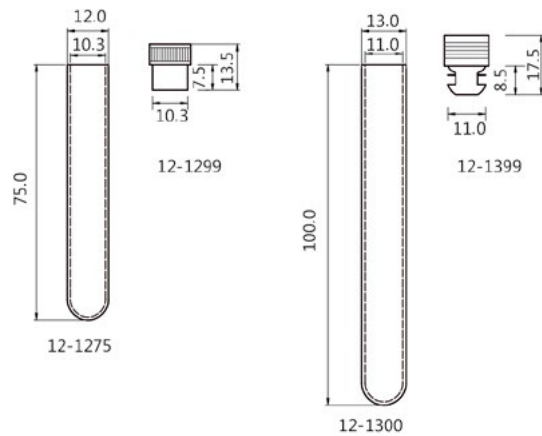

Dimensions = mm

Cat #	Description	Size(mm)	Material	Color	Volume	Sterile	Unit	Total
12-1275	Tube	12x75	PS	Clear	5ml	No	500 /Bag, 4 Bags/Case	2000 /Case
12-2275	Tube	12x75	PP	Clear	5ml	No	500 /Bag, 4 Bags/Case	2000 /Case
12-1300	Tube	13x100	PS	Clear	8ml	No	250 /Bag, 8 Bags/Case	2000 /Case
12-1299	Cap	12x13.5	PE	Blue	-	No	1,000 /Bag, 2 Bags/Case	2000 /Case
12-1399	Cap	13x17.5	PE	Red	-	No	1,000 /Bag, 2 Bags/Case	2000 /Case

# Slide Storage Boxes

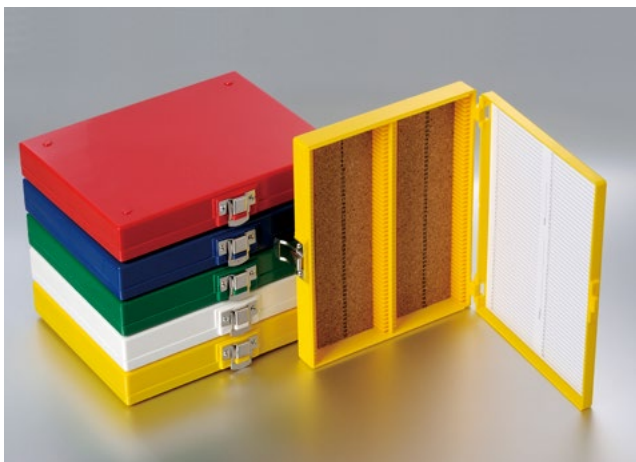

## >> Features

### Microscope Slides

- Made of high quality, highly transparent glass
- Slide surface highly polished  
Ground edges prevent chipping and personal injury
- Slides with frosted area are convenient for labeling and storage  
Slides without frosted area have a larger usable surface area

### Slide Storage Boxes

- Made of strong ABS material
- Available in 25-place or 100-place sizes
- Traditional cork or foam lining available
- 5 assorted colors available: red, yellow, green, blue, and white
- Store 25mm x 75mm microscope slides
- Each slot is numbered to correspond to the slide inventory sheet inside the lid
- 100-place slide boxes are secured with a rust-resistant clasp and hinge pin

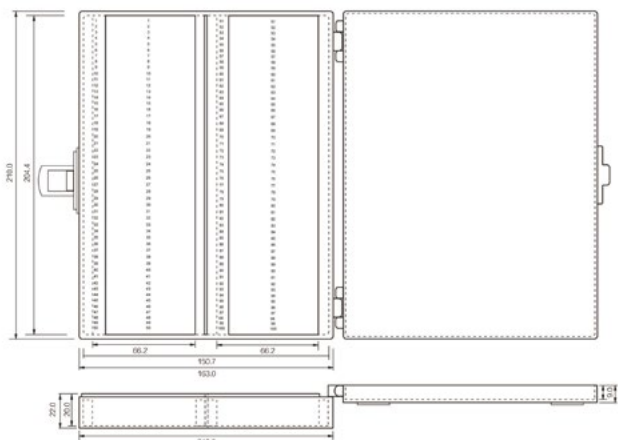

41-5100

Dimensions = mm

## Microscope Slides

Cat #	Material	Type	Size (mm)	Sterile	Unit	Total
7101	Clear Glass	Plain Slides	25.4 x 76.2	No	72 /Pack, 50 Packs/Case	3600 /Case
7105	Clear Glass	Single Frosted End	25.4 x 76.2	No	72 /Pack, 50 Packs/Case	3600 /Case

## Slide Storage Boxes

Cat #	Place	Lining	Color	Sterile	Unit	Total
41-5025	25-place	Foam	Assorted	No	5 /Bag, 4 Bags/Case	20 /Case
41-6025	25-place	Cork	Assorted	No	5 /Bag, 4 Bags/Case	20 /Case
41-5100	100-place	Foam	Assorted	No	5 /Bag, 6 Bags/Case	30 /Case
41-6100	100-place	Cork	Assorted	No	5 /Bag, 6 Bags/Case	30 /Case

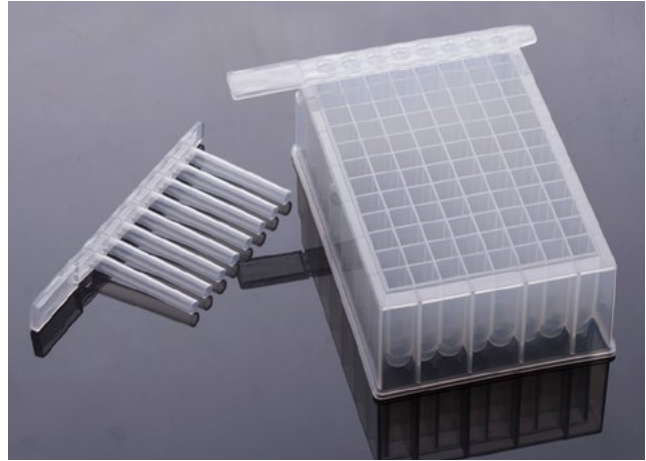

## >> Features

- Made of medical grade polypropylene, autoclavable
- Chemically resistant to alcohols and mild organic solvents
- 0.5ml, 1.0ml, 1.6ml, 2.2ml and 10ml volumes available
- Square and round wells, V and U bottom available
- DNase & RNase free, pyrogen free
- Can be sealed with sealing films or silicone sealing mats
- Confirms with SBS standards for automation
- Compatible with automated nucleic acid extraction equipment
- Sterilized, individual wrapped, and with lid type optional

Can be sealed with sealing film or silicone covers

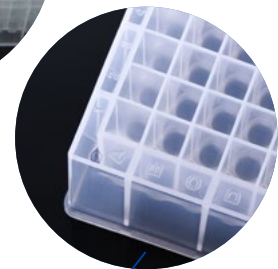

Molded alphanumeric labeling

Cat #	Volume	Description	Cap	Sterile	Unit
02-8005	0.5ml	Square 96 wells, V bottom, KingFisher Flex system	No	No	10 Pieces/Pack, 100 Pieces/Case
02-2010-50	1.0ml	Round 96 wells, U bottom,	No	No	10 Pieces/Pack, 50 Pieces/Case
02-1016	1.6ml	Square 96 wells, U bottom	No	No	24 Pieces/Pack, 96 Pieces/Case
02-1022	2.2ml	Square 96 wells, U bottom	No	No	24 Pieces/Pack, 96 Pieces/Case
02-6022	2.2ml	Square 96 wells, U bottom, profile concave	No	No	24 Pieces/Pack, 96 Pieces/Case
02-7022	2.2ml	Square 96 wells, V bottom, KingFisher Flex system	No	No	10 Pieces/Pack, 50 Pieces/Case
02-9010	10ml	Square 24 wells, V bottom, KingFisher Flex system	No	No	10 Pieces/Pack, 50 Pieces/Case
02-0096	/	96-well magnet set	/	No	2 Pieces/Pack, 50 Pieces/Case
02-0008	/	8-strip magnet set	/	No	2 Pieces/Pack, 100 Pieces/Case
02-1096	/	96 square silicone sealing mats, for 96 square deep well plates	/	No	10 Pieces/Pack, 50 Pieces/Case
02-1196	/	96 square silicone sealing mats, can be punctured, for 96 square deep well plates	/	No	10 Pieces/Pack, 50 Pieces/Case
02-2196	/	96 round silicone sealing mats, can be punctured, for 1.0ml plates	/	No	10 Pieces/Pack, 50 Pieces/Case
02-2296	/	96 round silicone sealing mats, can be punctured, for 2.0ml plates	/	No	10 Pieces/Pack, 50 Pieces/Case
02-3024	/	24 square silicone sealing mats, for 24 square deep well plates 10ml	/	No	10 Pieces/Pack, 50 Pieces/Case

\* Sterilized, individual wrapped, and with lid type optional.

# Sealing Films



## >> Features

- Made of High quality polypropylene, transparent polyester, hard polyester, impermeable aluminum foil, vinyl
- Well with not only PCR, qPCR, ELISA, inoculation and fluorescence experiment but also general and high throughput operation
- Applied to ELISA, inoculation, sample storage and microorganism cultivation sterile/ non-sterile
- Multiple temperature ranges are available, -80°C , -70°C , -40°C , -20°C , +80°C , 90°C , +100°C , +120°C
- Colored sealers with five options are available, green/purple/orange/red/blue
- Film-sealing paddle and plate roller are optional

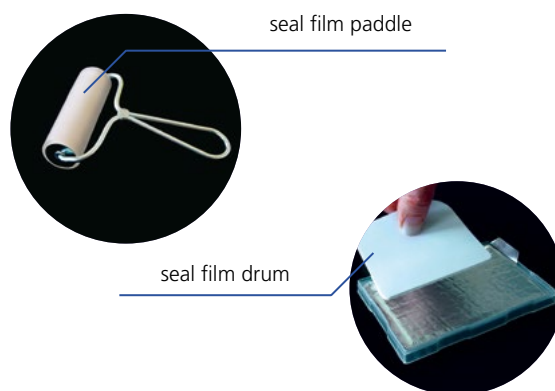

Cat#	Material	Temperature range	Application	Sterile	Unit	Total
61-0010	Polypropylene	-40°C ~ +120°C	ELISA, inoculation	No	100 Pieces/Box	100 /Case
61-0020	Impermeable aluminum foil	-80°C ~+120°C	PCR, cold storage of sample	No	100 Pieces/Box	100 /Case
61-0040	Hard polyester	-40°C ~ +120°C	PCR, qPCR and sample storage	No	100 Pieces/Box	100 /Case
61-0041	Hard polyester	-40°C ~+120°C	PCR, qPCR and sample storage	No	100 pieces/Box	100 /Case
61-0051	Thick porous hydrophobic rayon	-20°C ~+80°C	biological culture	Yes	50 Pieces/Box	50 /Case
61-0060	Thick vinyl	-40°C ~ +90°C	automatic sampling	No	100 Pieces/Box	100 /Case
61-0080	DMSO resistant sealing foil	-80°C ~+120°C	PCR, photosensitive test and mechanical operation	No	100 Pieces/Box	100 /Case
61-0120	Hard polyester	-40°C ~ +120°C	ELISA, inoculation	Yes	2 Rolls/Box, 100 Pieces/Roll, equip with dispenser	200 /Case
61-0152	Thick porous hydrophobic rayon	-20°C ~+80°C	biological culture	Yes	2 Rolls/Box, 50 Pieces/Roll, equip with dispenser	100 /Case
61-0210	Polyolefin	-70°C ~ +100°C	qPCR, sample storage and protein crystallization	No	100 Pieces/Box	100 /Case
61-0303	Transparent polyester	-40°C ~+120°C	PCR, qPCR and sample storage	No	400 Pieces/Box	400 /Case
61-0304	Aluminum foil	-80°C ~ +120°C	PCR, sample storage photosensitive test, automatic operation	No	300 Strip/Box	300 /Case



Latex



Nitrile

## >> Features

- Available in powder free latex and powder free nitrile
- Textured fingertips for an improved grip  
Beaded cuff design helps users don gloves efficiently
- Non-sterile

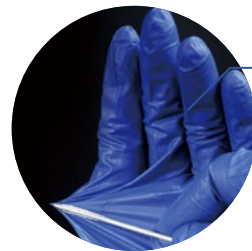

Nitrile material promotes better puncture



Ambidextrous

Cat #	Material	Size	Color	Unit	Total
97-1111	Latex	XS	Natural Off-White	100 /Pack, 10 Packs/Case	1000 /Case
97-1112	Latex	S	Natural Off-White	100 /Pack, 10 Packs/Case	1000 /Case
97-1113	Latex	M	Natural Off-White	100 /Pack, 10 Packs/Case	1000 /Case
97-1114	Latex	L	Natural Off-White	100 /Pack, 10 Packs/Case	1000 /Case
97-1115	Latex	XL	Natural Off-White	100 /Pack, 10 Packs/Case	1000 /Case
97-6111	Nitrile	XS	Blue	100 /Pack, 10 Packs/Case	1000 /Case
97-6112	Nitrile	S	Blue	100 /Pack, 10 Packs/Case	1000 /Case
97-6113	Nitrile	M	Blue	100 /Pack, 10 Packs/Case	1000 /Case
97-6114	Nitrile	L	Blue	100 /Pack, 10 Packs/Case	1000 /Case
97-6115	Nitrile	XL	Blue	100 /Pack, 10 Packs/Case	1000 /Case



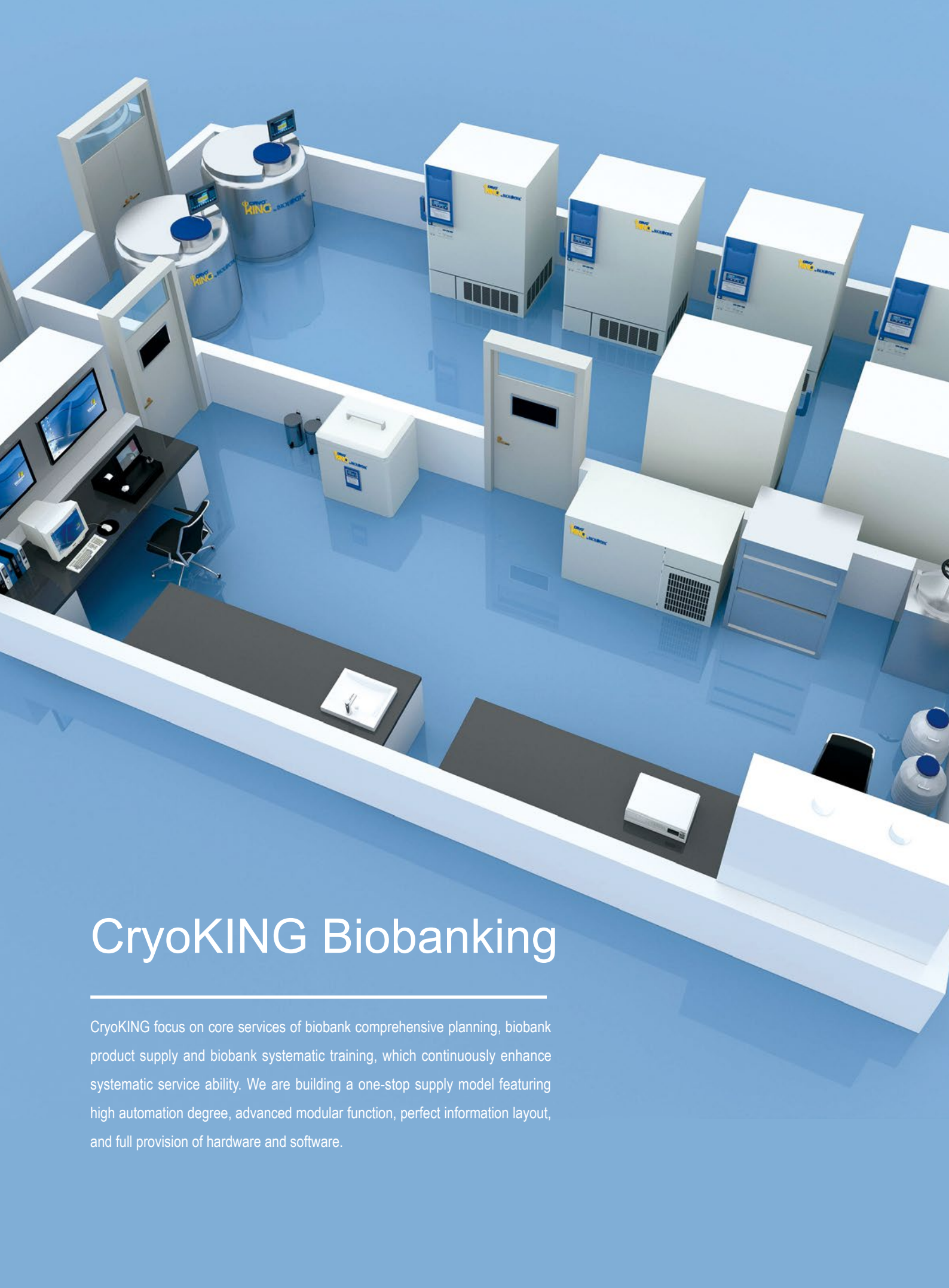

# CryoKING Biobanking

---

CryoKING focus on core services of biobank comprehensive planning, biobank product supply and biobank systematic training, which continuously enhance systematic service ability. We are building a one-stop supply model featuring high automation degree, advanced modular function, perfect information layout, and full provision of hardware and software.



## >> Features

- Made of medical grade polypropylene
- Can be repeatedly frozen and thawed
- Universal screw threads for use
- Tubes fit most common rotors
- Tubes fit standard 1-inch and 2-inch
- Autoclavable to 121°C and freezable to -86°C

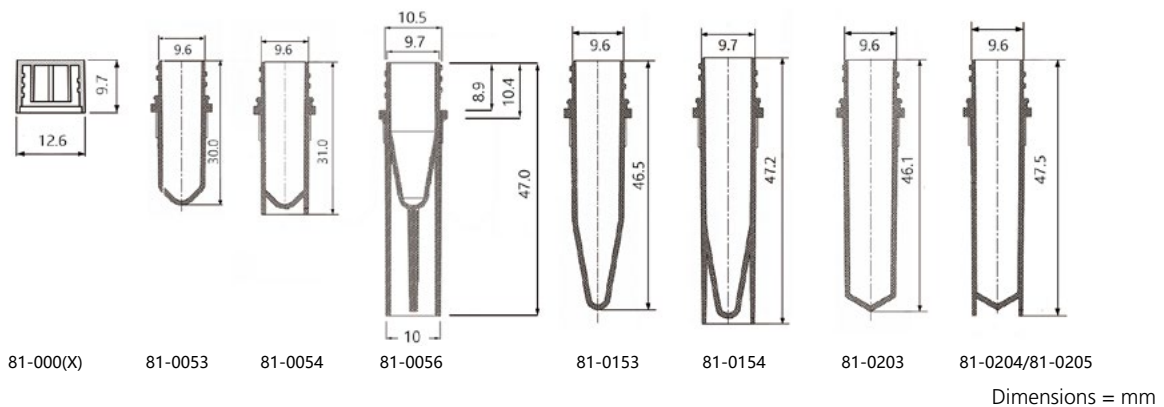

Cat#	Type	Volume	Height	Color	Bottom	Sterile	Unit	Total
81-0053	Tubes	0.5ml	30.0	Clear	Conical	No	500 /Bag/Pack, 10 Packs/Case	5000 /Case
81-0054	Tubes	0.5ml	31.0	Clear	Self-Standing	No	500 /Bag/Pack, 10 Packs/Case	5000 /Case
81-0055	Tubes	0.5ml	47.5	Brown	Self-Standing	No	500 /Bag/Pack, 10 Packs/Case	5000 /Case
81-0056	Tubes	0.5ml	47.5	Clear	Self-Standing	No	500 /Bag/Pack, 10 Packs/Case	5000 /Case
81-0153	Tubes	1.5ml	46.5	Clear	Conical	No	500 /Bag/Pack, 10 Packs/Case	5000 /Case
81-0154	Tubes	1.5ml	47.5	Clear	Self-Standing	No	500 /Bag/Pack, 10 Packs/Case	5000 /Case
81-0203	Tubes	2.0ml	46.1	Clear	Conical	No	500 /Bag/Pack, 10 Packs/Case	5000 /Case
81-0204	Tubes	2.0ml	47.5	Clear	Self-Standing	No	500 /Bag/Pack, 10 Packs/Case	5000 /Case
81-0205	Tubes	2.0ml	47.5	Brown	Self-Standing	No	500 /Bag/Pack, 10 Packs/Case	5000 /Case
81-0000	Caps	-	9.7	Clear	-	No	500 /Bag/Pack, 10 Packs/Case	5000 /Case
81-0001*	Caps	-	9.7	Pink	-	No	500 /Bag/Pack, 10 Packs/Case	5000 /Case
81-0002*	Caps	-	9.7	Green	-	No	500 /Bag/Pack, 10 Packs/Case	5000 /Case
81-0003*	Caps	-	9.7	Blue	-	No	500 /Bag/Pack, 10 Packs/Case	5000 /Case
81-0004*	Caps	-	9.7	Yellow	-	No	500 /Bag/Pack, 10 Packs/Case	5000 /Case
81-0005*	Caps	-	9.7	Assorted	-	No	500 /Bag/Pack, 10 Packs/Case	5000 /Case
81-0006	Caps	-	9.7	Brown	-	No	500 /Bag/Pack, 10 Packs/Case	5000 /Case

\* Call for details.



# Cryogenic Vials



81-8204

## >> Features

- Made of medical grade polypropylene
- Autoclavable
- Can be repeatedly frozen and thawed
- Universal screw threads
- Vials fit standard 1-inch and 2-inch freezer boxes
- Gamma radiation sterilized
- DNase & RNase free, endotoxin free, and human DNA free
- 81-8204 2ml self-standing vials have a white writing area and black graduations
- Autoclavable to 121 °C and freezable to -86 °C

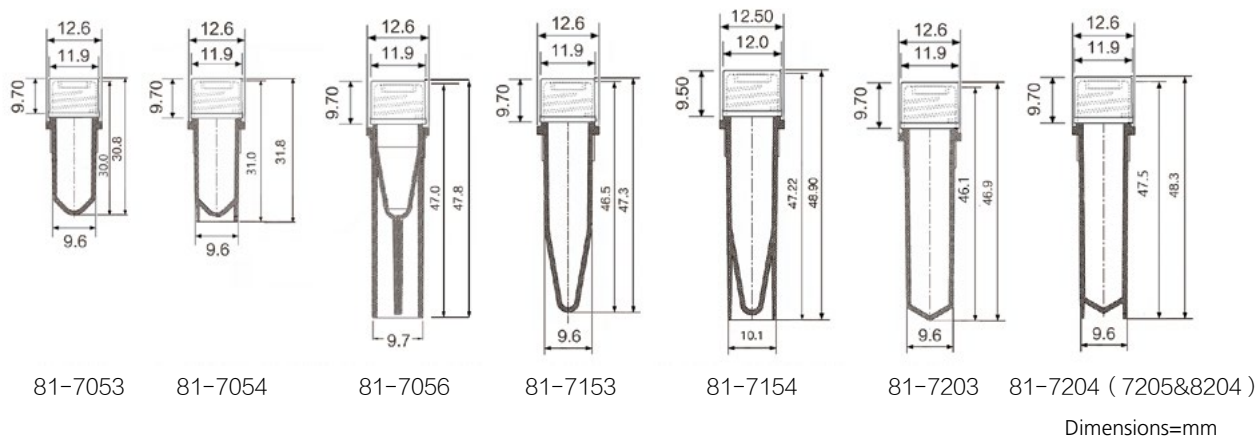

Cat #	Volume	Color	Height	Bottom	Writing Area	Sterile	Unit	Total
81-7053*	0.5ml	Clear	30.0	Conical	No	Yes	50 /Bag, 10 Bags/Pack, 4 Packs/Case	2000 /Case
81-7054	0.5ml	Clear	31.0	Self-Standing	No	Yes	50 /Bag, 10 Bags/Pack, 4 Packs/Case	2000 /Case
81-7055	0.5ml	Brown	47.5	Self-Standing	No	Yes	50 /Bag, 10 Bags/Pack, 4 Packs/Case	2000 /Case
81-7056	0.5ml	Clear	47.5	Self-Standing	No	Yes	50 /Bag, 10 Bags/Pack, 4 Packs/Case	2000 /Case
81-7153	1.5ml	Clear	46.5	Conical	No	Yes	50 /Bag, 10 Bags/Pack, 4 Packs/Case	2000 /Case
81-7154	1.5ml	Clear	47.5	Self-Standing	No	Yes	50 /Bag, 10 Bags/Pack, 4 Packs/Case	2000 /Case
81-7203	2.0ml	Clear	46.1	Conical	No	Yes	50 /Bag, 10 Bags/Pack, 4 Packs/Case	2000 /Case
81-7204	2.0ml	Clear	47.5	Self-Standing	No	Yes	50 /Bag, 10 Bags/Pack, 4 Packs/Case	2000 /Case
81-7205	2.0ml	Brown	47.5	Self-Standing	No	Yes	50 /Bag, 10 Bags/Pack, 4 Packs/Case	2000 /Case
81-8204	2.0ml	Clear	47.5	Self-Standing	Yes	Yes	50 /Bag, 10 Bags/Pack, 4 Packs/Case	2000 /Case

\* Call for details.



## >> Features

- Made of medical grade polypropylene; Autoclavable; and can be repeatedly frozen and thawed
- 5ml vials are available with external screw threads, and 2ml vials are available with both external and internal screw threads. External thread screw vials' caps have no O-ring, which reduces the possibility of contamination
- Fit 9x9 (81-well) standard cryogenic boxes
- Tubes with black graduation printing and white writing area
- Gamma radiations sterilized, RNase and DNase free, endotoxin free and foreign DNA free
- Pre-set 1D barcodes and numbers on sides for immediate scanning

## Specifications

- Working temperature: stable from -196°C to 121°C
- Suitable for liquid nitrogen freezing(vapor phase)



88-320S

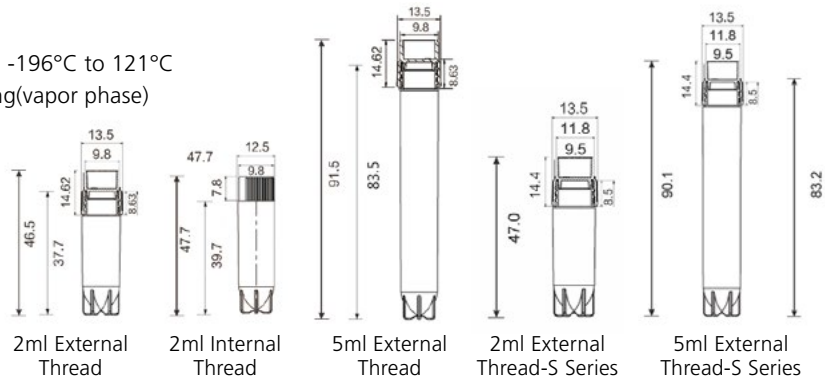

Dimensions=mm

Cat #	Type	Thread Type	Volume	Bottom	Side Barcode	Writing Area	Sterile	Unit	Total
88-321X	Tubes	Internal	2ml	Self-Standing	No	Yes	Yes	25 Sets/Bag, 40 Bags/Case	1000 Sets/Case
88-320X	Tubes	External	2ml	Self-Standing	No	Yes	Yes	25 Sets/Bag, 40 Bags/Case	1000 Sets/Case
88-350X	Tubes	External	5ml	Self-Standing	No	Yes	Yes	25 Sets/Bag, 40 Bags/Case	1000 Sets/Case
88-621X	Tubes	Internal	2ml	Self-Standing	Yes	Yes	Yes	25 Sets/Bag, 40 Bags/Case	1000 Sets/Case
88-620X	Tubes	External	2ml	Self-Standing	Yes	Yes	Yes	25 Sets/Bag, 40 Bags/Case	1000 Sets/Case
88-650X	Tubes	External	5ml	Self-Standing	Yes	Yes	Yes	25 Sets/Bag, 40 Bags/Case	1000 Sets/Case
88-600X	Markers	-	-	-	-	-	-	100 Sets/Bag, 30 Bags/Case	3000 Sets/Case
88-320XS	Tubes	External	2ml	Self-Standing	No	Yes	Yes	25 Sets/Bag, 40 Bags/Case	1000 Sets/Case
88-350XS	Tubes	External	5ml	Self-Standing	No	Yes	Yes	25 Sets/Bag, 40 Bags/Case	1000 Sets/Case
88-620XS	Tubes	External	2ml	Self-Standing	Yes	Yes	Yes	25 Sets/Bag, 40 Bags/Case	1000 Sets/Case
88-650XS	Tubes	External	5ml	Self-Standing	Yes	Yes	Yes	25 Sets/Bag, 40 Bags/Case	1000 Sets/Case

X—Color of Caps : 0—White, 1—Red, 2—Green, 3—Blue, 4—Yellow, 5—Purple, 7—Clear

80-6006—Assorted Color

# CryoKING Cryogenic Vials



## >> Features

- Made of medical grade polypropylene, can be repeatedly frozen and thawed
- Vials have a white writing area and black graduations; 6 different colored caps are available
- Vials with pre-set Datamatrix 2D barcodes are available, and the 2D barcodes can be customized
- Use the microscopic imaging technique to pre-set 2D barcodes
- Gamma radiation sterilized, DNase & RNase free, endotoxin free, foreign DNA free
- Pre-set 1D barcodes and human readable numbers on sides for visual identification, and can be read by various scanners

## Specifications

- Working temperature: stable from -196°C to 121°C
- Suitable for liquid nitrogen freezing(vapor phase)

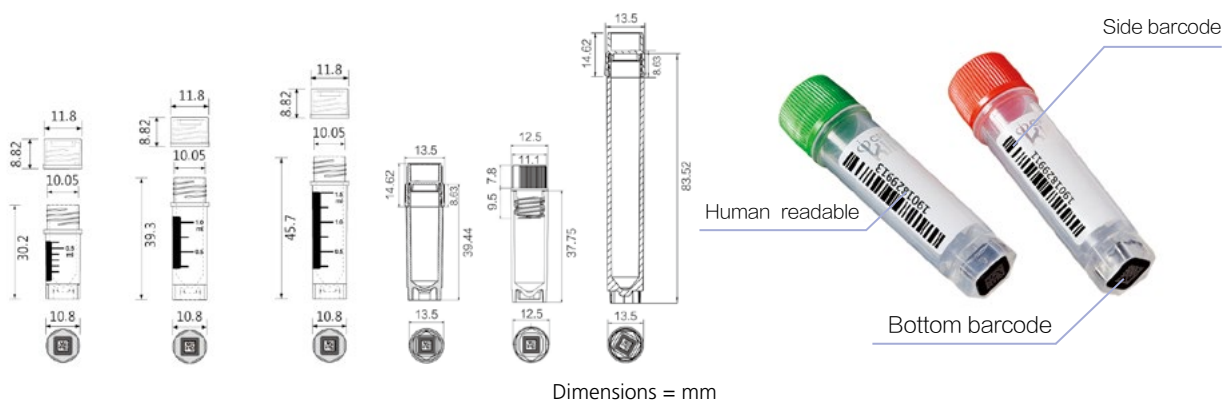

Cat #	Cat# (Upgraded, with Side Barcode)	Thread Type	Volume	Bottom	Bottom Barcode	Writing Area	Sterile	Unit	Total
88-005X	88-605X	External	0.5ml	Self-Standing	No	Yes	Yes	25 Sets/Bag, 40 Bags/Case	1000 Sets/Case
88-010X	88-610X	External	1.0ml	Self-Standing	No	Yes	Yes	25 Sets/Bag, 40 Bags/Case	1000 Sets/Case
88-015X	88-615X	External	1.5ml	Self-Standing	No	Yes	Yes	25 Sets/Bag, 40 Bags/Case	1000 Sets/Case
88-020X	88-720X	External	2.0ml	Self-Standing	No	Yes	Yes	25 Sets/Bag, 40 Bags/Case	1000 Sets/Case
88-021X	88-721X	Internal	2.0ml	Self-Standing	No	Yes	Yes	25 Sets/Bag, 40 Bags/Case	1000 Sets/Case
88-050X	88-750X	External	5.0ml	Self-Standing	No	Yes	Yes	25 Sets/Bag, 40 Bags/Case	1000 Sets/Case
-	88-905X	External	0.5ml	Self-Standing	Yes	Yes	Yes	25 Sets/Bag, 40 Bags/Case	1000 Sets/Case
-	88-910X	External	1.0ml	Self-Standing	Yes	Yes	Yes	25 Sets/Bag, 40 Bags/Case	1000 Sets/Case
-	88-915X	External	1.5ml	Self-Standing	Yes	Yes	Yes	25 Sets/Bag, 40 Bags/Case	1000 Sets/Case
-	88-920X	External	2.0ml	Self-Standing	Yes	Yes	Yes	25 Sets/Bag, 40 Bags/Case	1000 Sets/Case
-	88-921X	Internal	2.0ml	Self-Standing	Yes	Yes	Yes	25 Sets/Bag, 40 Bags/Case	1000 Sets/Case
-	88-950X	External	5.0ml	Self-Standing	Yes	Yes	Yes	25 Sets/Bag, 40 Bags/Case	1000 Sets/Case

X--Cap Color : 0-White,1-Red,2-Green,3-Blue,4-Yellow,5-Purple, 7-Clear

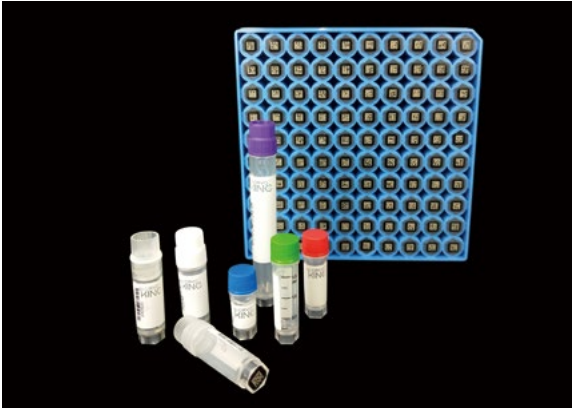

## >> Features

- All you need in one package:
  - CryoKING Vials with pre-set 2D barcodes
  - Pre-assembled inside the CryoKING Boxes
  - Pre-sterilized
- Certified: foreign DNA free, DNase & RNase free, endotoxin free
- Rapidly scans and identifies an entire box full of vials
- Pre-set 1D barcodes and numbers on side for immediate scanning or visual identification.

## Specifications

- Working temperature: stable from -196°C to 121°C
- Suitable for liquid nitrogen freezing(vapor phase)

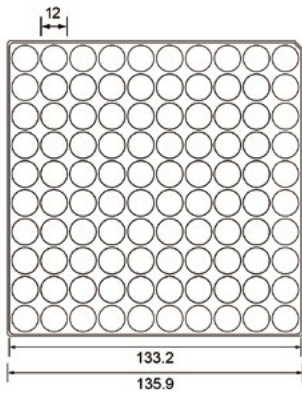

89-905X/89-910X/89-915X

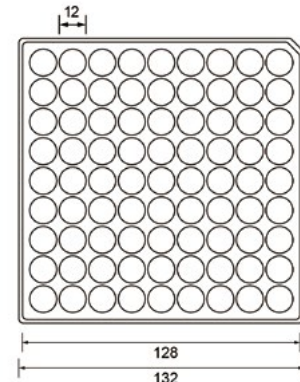
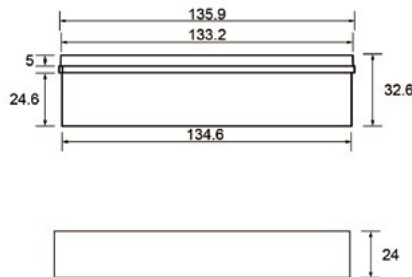

89-920X/89-921X/89-950X

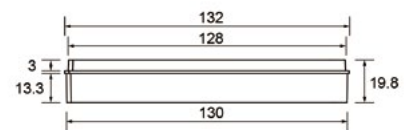

Dimensions = mm

Cat #	Volume	Bottom barcode	Side Code	Wells	Thread Type	Dimensions(mm)	Unit	Total
89-905X	0.5ml Vials + 1 inBox	Yes	Yes	100-well	External	133x133x36	6 Bags/Pack, 2 Packs/Case	12 Bags/Case
89-910X	1.0ml Vials + 2 inBox	Yes	Yes	100-well	External	133x133x52	6 Bags/Pack, 2 Packs/Case	12 Bags/Case
89-915X	1.5ml Vials + 2 inBox	Yes	Yes	100-well	External	133x133x52	6 Bags/Pack, 2 Packs/Case	12 Bags/Case
89-922X	2.0ml Vials + 2 inBox	Yes	Yes	100-well	External	136x136x52	6 Bags/Pack, 2 Packs/Case	12 Bags/Case
89-923X	2.0ml Vials + 2 inBox	Yes	Yes	100-well	Internal	136x136x52	6 Bags/Pack, 2 Packs/Case	12 Bags/Case
89-920X	2.0ml Vials + 2 inBox	Yes	Yes	81-well	External	133x133x52	6 Bags/Pack, 2 Packs/Case	12 Bags/Case
89-921X	2.0ml Vials + 2 inBox	Yes	Yes	81-well	Internal	133x133x52	6 Bags/Pack, 2 Packs/Case	12 Bags/Case
89-950X	5.0ml Vials + 3.75 inBox	Yes	Yes	81-well	External	133x133x95	6 Bags/Pack, 2 Packs/Case	12 Bags/Case

X--Cap Color : 0-White,1-Red,2-Green,3-Blue,4-Yellow,5-Purple, 7-Clear



# Automated Product Series of SBS Standards-Internal Thread

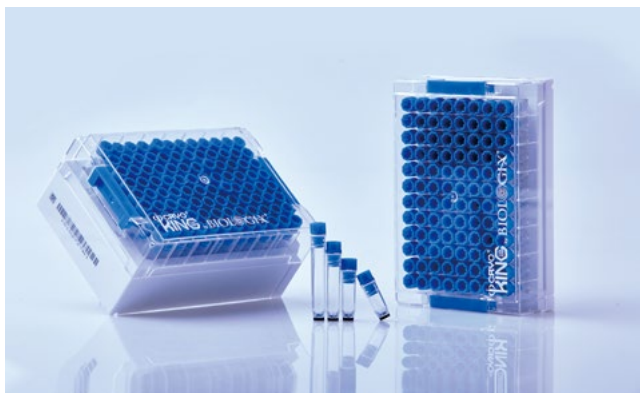

## >> Features

- 2D barcodes on 96-well format cryogenic vials are easy to be read
- 2D barcode and human-readable numbers on the side of SBS format racks; 2D barcode at the bottom of racks, cryogenic vials and racks can be traced at the same time
- Simple and powerful mechanical locking function, slide the buttons on both sides to unlock
- Laser etched 2D barcodes, resistant to DMSO and other organic solvents
- SBS format rack fits 96-well format cryogenic vials perfectly for automatic operations

## Specifications

- Working temperature: stable from -196°C to 121°C
- Suitable for liquid nitrogen freezing(vapor phase)



## 96-well SBS Cryogenic Vials

Cat #	Thread Type	Volume	Bottom	Bottom Barcode	Writing Area	Sterile	Unit	Total
88-403X	Internal	300µl	Self-Standing	Yes	No	Yes	96 Sets/Bag, 10 Bags/Pack, 2 Packs/Case	1920 Sets/Case
88-405X	Internal	500µl	Self-Standing	Yes	No	Yes	96 Sets/Bag, 10 Bags/Pack, 2 Packs/Case	1920 Sets/Case
88-408X	Internal	750µl	Self-Standing	Yes	No	Yes	96 Sets/Bag, 10 Bags/Pack, 2 Packs/Case	1920 Sets/Case
88-410X	Internal	1000µl	Self-Standing	Yes	No	Yes	96 Sets/Bag, 10 Bags/Pack, 2 Packs/Case	1920 Sets/Case

X--Cap Color : 0-White, 1-Red, 2-Green, 3-Blue, 4-Yellow, 5-Purple

## SBS Format Cryogenic Racks

Cat #	Vial Volume	Wells	Color	Dimensions(mm)	Unit	Total
98-4127	300µl & 500µl	96-well, square	White	128x85x35	10 /Pack , 2 Packs/Case	20 /Case
98-4227	750µl & 1000µl	96-well, square	White	128x85x54	10 /Pack , 2 Packs/Case	20 /Case

## SBS Format Combo

Cat #	Description	Bottom Barcode	Side Barcode	Wells	Dimensions(mm)	Unit
89-423X	300µl Vials+Rack	Yes	No	96-well, square	128x85x35	1 Set/Bag , 10 Bags/Pack , 2 Packs/Case
89-425X	500µl Vials+Rack	Yes	No	96-well, square	128x85x35	1 Set/Bag , 10 Bags/Pack , 2 Packs/Case
89-428X	750µl Vials+Rack	Yes	No	96-well, square	128x85x54	1 Set/Bag , 10 Bags/Pack , 2 Packs/Case
89-421X	1000µl Vials+Rack	Yes	No	96-well, square	128x85x54	1 Set/Bag , 10 Bags/Pack , 2 Packs/Case

X--Cap Color : 0-White , 1-Red , 2-Green , 3-Blue , 4-Yellow , 5-Purple

# Automated Products Series of SBS Standards-External Thread



## >> Features

- Vials: Made of medical grade polypropylene, 2-Color injection molding technique. Four codes on one vial: Bottom: Laser etched 2D code and human-readable codes; Side: Laser etched 1D barcode and human-readable codes.
- Racks: Side: Laser etched 1D barcode, 2D code, and human-readable codes; Bottom: 2D code. Pre-set alphanumeric marks for sample identification. Can be used with CKS-1301 CryoKING scanner to manager samples.
- 100,000 grade clean room enables safe vials.
- Gamma radiations sterilized; DNase & RNase free, endotoxin free, foreign DNA free.
- Stable from -196°C to 121°C, can be stored in vapor phase liquid nitrogen.
- Compatible with Micronic cappers & decappers and sample management system.



Cat #	Description	Unit
88-514X	CryoKING SBS vials, 1.4ml, external thread; Self-Standing; 2-color injection molding technique; Laser-etched 4 codes. Sterile.	96 Sets/Bag, 10 Bags/Pack, 2 Packs/Cas
98-5227	CryoKING SBS format racks, available for 1.4ml external vials; 96-well; Square holes, White; Dimensions(mm): 128x85x56. Non sterile.	10 /Pack, 2 Packs/Case
89-514X	CryoKING SBS Combo, 1.4ml Vials + Rack. Dimensions(mm): 128x85x56. Sterile.	1 Set/Bag, 10 Bags/Pack, 2 Packs/Case

X—Cap Color: 1—Sky blue, 2—Lime green, 3—Biologix blue, 5—Lavender purple



# Premium Cardboard Cryogenic Boxes



## >> Features

- Made of durable cardboard with superior white outer coating
- Chemically resistant to alcohols and mild organic solvents
- Five assorted colors available: white, yellow, pink, blue, and green
- White Premium Cardboard Freezer Boxes have a glossy coating, other colors have a matte coating
- Water resistant coating for improved durability
- Superior white 90-1281 & 90-1200 cardboard cryogenic boxes without outer coating are also available
- Holds 0.5ml, 1.5ml, 2.0ml, 5ml and 10ml microtubes and 15ml or 50ml Centrifuge Tubes

## Specifications

- Working temperature: stable from -196°C to 121°C
- Suitable for liquid nitrogen freezing

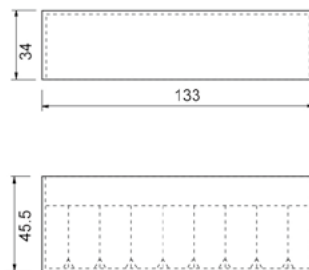
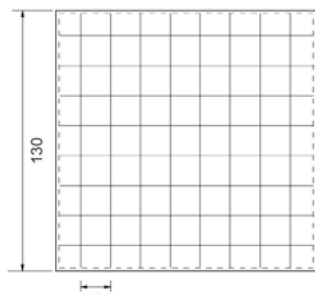

90-2281

Dimensions = mm

Cat #	Height	Wells	Description	Dimensions (mm)	Unit	Total
90-1200	2 in	100-well	Superior white without outer coating	132 x 132 x 53	5 /Bag, 20 Bags/Case	100 /Case
90-1281	2 in	81-well	Superior white without outer coating	132 x 132 x 53	5 /Bag, 20 Bags/Case	100 /Case
90-1300	3 in	100-well	Superior white without outer coating	133 x 133 x 76	5 /Bag, 20 Bags/Case	100 /Case
90-1381	3 in	81-well	Superior white without outer coating	133 x 133 x 76	5 /Bag, 20 Bags/Case	100 /Case
90-2281	2 in	81-well	White coating, plastic coating	133 x 133 x 52	5 /Bag, 20 Bags/Case	100 /Case
90-2200	2 in	100-well	White coating, plastic coating	133 x 133 x 52	5 /Bag, 20 Bags/Case	100 /Case
90-5281	2 in	81-well	Rainbow outer coating, matte coating	133 x 133 x 52	5 /Bag, 20 Bags/Case	100 /Case
90-5200	2 in	100-well	Rainbow outer coating, matte coating	133 x 133 x 52	5 /Bag, 20 Bags/Case	100 /Case
90-2381	3 in	81-well	White coating, plastic coating	133 x 133 x 76	5 /Bag, 20 Bags/Case	100 /Case
90-2300	3 in	100-well	White coating, plastic coating	133 x 133 x 76	5 /Bag, 20 Bags/Case	100 /Case

# ID-Color™ Cardboard Cryogenic Boxes



## >> Features

- Made of durable cardboard with a waterproof coating and polypropylene dividers
- Connected lid design ensures that lids are never misplaced or mixed up
- Alphanumeric labeling featured on the lid, bottom, and four sides enables quick and easy identification of samples
- Holds 0.5ml/1.5ml/2.0ml/5.0ml microtubes and cryogenic vials

## Specifications

- Suitable for liquid nitrogen freezing (after adding vent holes, and using cardboard dividers)

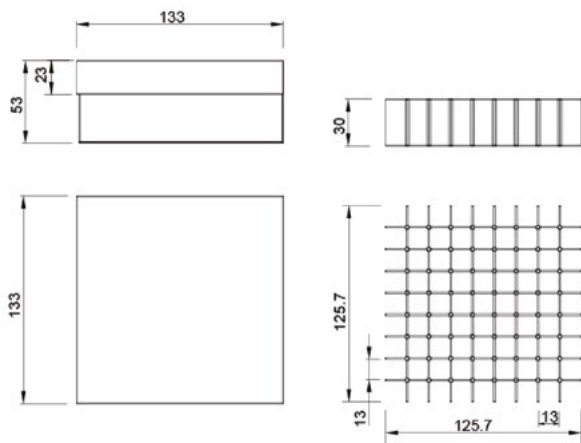

90-8281

Dimensions = mm

Post-style dividers

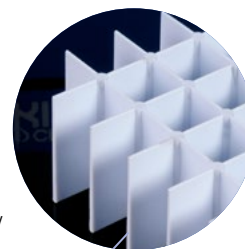
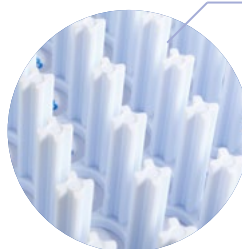

Straight grid divider design, resistant to low temperature

Cat #	Height	Well	Divider Material	Dimensions (mm)	Unit	Total
90-8100	1in	100-well	PP	133 x 133 x 36	5 /Bag, 4 Bags/Case	20 /Case
90-8281	2in	81-well	PP	133 x 133 x 52	5 /Bag, 4 Bags/Case	20 /Case
90-8200	2in	100-well	PP	133 x 133 x 52	5 /Bag, 4 Bags/Case	20 /Case
90-8381	3.75in	81-well	PP	133 x 133 x 95	5 /Bag, 4 Bags/Case	20 /Case

# PC Cryogenic Boxes

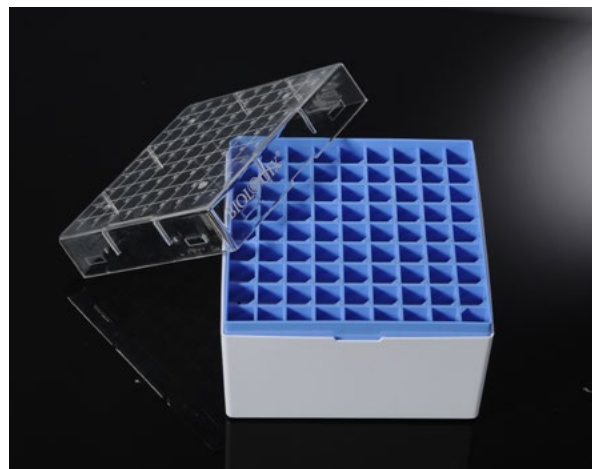

## >> Features

- Made of tough polycarbonate, chemically resistant to alcohols and mild organic solvents
- Can be repeatedly frozen and thawed
- 5x5 (25-well), 9x9 (81-well), or 10x10 (100-well) boxes available
- Compatible with 0.5ml, 1.5ml, 2.0ml or 5.0ml microtubes and cryogenic vials
- Numbered grids for sample identification
- Drain holes and air vents minimize condensation
- Five assorted colors available

## Specifications

- Suitable for storage in freezers or liquid nitrogen
- Temperature range: stable from -196°C to 121°C

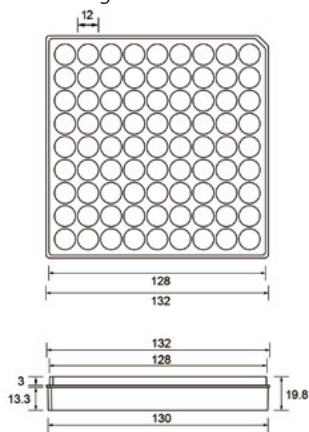
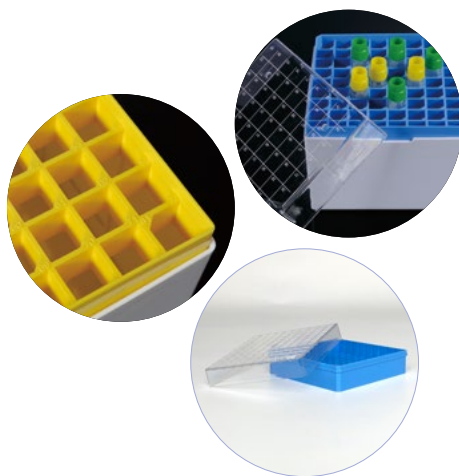

90-9009/90-9381/98-0313/98-1213

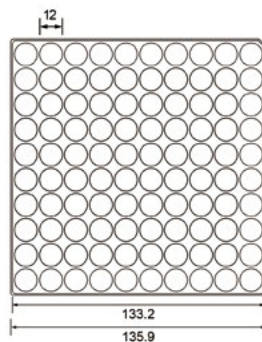

98-0113/98-0213/90-9210/98-0200

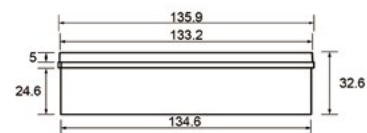

Cat #	Height	Wells	Color	Dimensions (mm)	Unit	Total
90-9009	2 in	81-well	Assorted Colors	133x133x52	5 /Bag, 4 Bags/Case	20 /Case
90-9210	2 in	100-well	Assorted Colors	133x133x52	5 /Bag, 4 Bags/Case	20 /Case
90-9250	2 in	25-well	Assorted Colors	75x75x52	5 /Bag, 6 Bags/Case	30 /Case
90-9381	3.75 in	81-well	Assorted Colors	133x133x95	5 /Bag, 4 Bags/Case	20 /Case
98-0113	1 in	100-well	Blue	133x133x36	3 /Bag, 4 Bags/Case	12 /Case
98-0200	2 in	100-well	Blue	136x136x52	3 /Bag, 4 Bags/Case	12 /Case
98-0213	2 in	100-well	Blue	133x133x52	3 /Bag, 4 Bags/Case	12 /Case
98-0313	3.75 in	81-well	Blue	133x133x95	3 /Bag, 4 Bags/Case	12 /Case
98-1213	2 in	81-well	Blue	133x133x52	3 /Bag, 4 Bags/Case	12 /Case

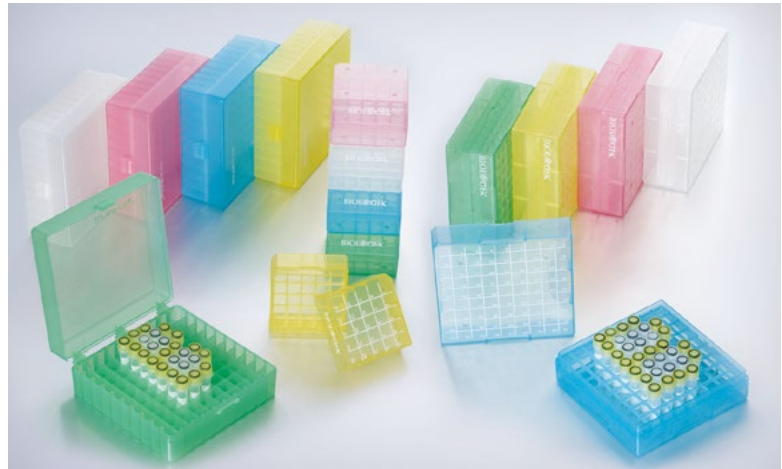
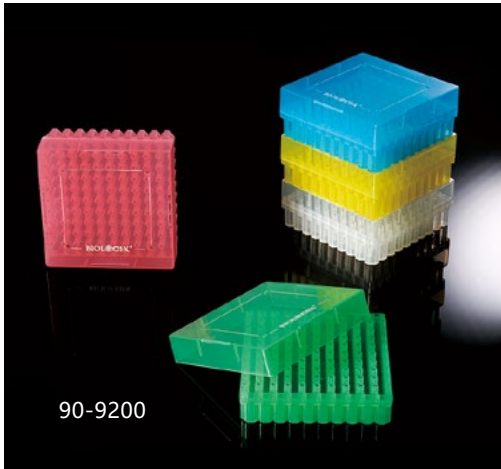

## >> Features

- Made of polypropylene, chemically resistant to alcohols and mild organic solvents
- Can be repeatedly frozen and thawed
- 5x5 (25-well), 9x9 (81-well), or 10x10 (100-well) boxes available
- Compatible with 0.5ml, 1.5ml or 2.0ml microtubes and cryogenic vials
- Numbered grids for sample identification
- Drain holes and air vents minimize condensation
- Five assorted colors available

## Specifications

- Suitable for storage in freezers
- Temperature range: stable from -86°C to 121°C

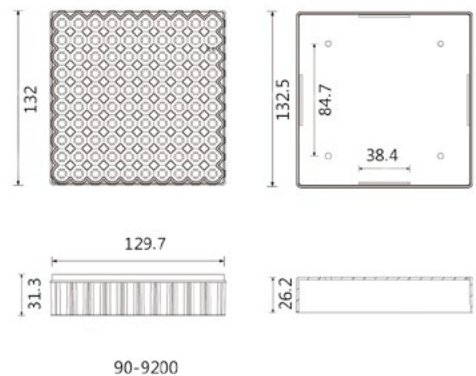

90-9200

Dimensions = mm



Number grid for sample identification



Convenient sample organization

Cat #	Height	Wells	Color	Dimensions (mm)	Unit	Total
90-9025	2 in	25-well	Assorted Colors	75 x 75 x 52	5 /Bag, 6 Bags/Case	30 /Case
90-9081	2 in	81-well	Assorted Colors	133 x 133 x 52	5 /Bag, 4 Bags/Case	20 /Case
90-9100	2 in	100-well	Assorted Colors	141 x 154 x 55	5 /Bag, 4 Bags/Case	20 /Case
90-9200	2 in	100-well	Assorted Colors	133 x 133 x 52	5 /Bag, 4 Bags/Case	20 /Case



# Freezer Racks



## Sliding Drawer Freezer Racks

- Made of corrosion-resistant stainless steel or aluminium alloy
- Ideal for storage of 1 inch and 2 inch standard size cryogenic boxes
- Fits most standard upright freezers
- Sliding Drawer Freezer Racks include folded rails to reduce frost
- Flanging design reduces scratching
- Handle design enables easy removal from the shelf
- Colored labels for drawer/sample identification
- Can be customized

Cat #	Material	Description	Capacity (D x H Configuration)	Dimensions(mm) (D x W x H)	Storage box size (mm)
99-7216	Stainless steel	Sliding Drawer Freezer Racks	4 x 4	564 x 141 x 229	133 x 133 x 52
99-7220	Stainless steel	Sliding Drawer Freezer Racks	4 x 5	564 x 141 x 285	133 x 133 x 52
99-7224	Stainless steel	Sliding Drawer Freezer Racks	4 x 6	564 x 141 x 341	133 x 133 x 52
96-7216	Aluminium alloy	Sliding Drawer Freezer Racks	4 x 4	564 x 141 x 231	133 x 133 x 52
96-7220	Aluminium alloy	Sliding Drawer Freezer Racks	4 x 5	564 x 141 x 288.5	133 x 133 x 52
96-7224	Aluminium alloy	Sliding Drawer Freezer Racks	4 x 6	564 x 141 x 346	133 x 133 x 52



## Frame Type Freezer Racks

- Made of corrosion-resistant stainless steel or aluminium alloy
- Ideal for storage of 1 inch and 2 inch standard size cryogenic boxes
- Fits most standard upright freezers
- Simple structure and lightweight design helps manage cryogenic boxes efficiently
- Can be customized

Cat #	Material	Description	Capacity (D x H Configuration)	Dimensions (mm) (D x W x H)	Storage box size (mm)
96-2216	Aluminium alloy	Frame Type Freezer Racks	4 x 4	552 x 137 x 228	133 x 133 x 52
96-2220	Aluminium alloy	Frame Type Freezer Racks	4 x 5	552 x 137 x 284	133 x 133 x 52
96-2224	Aluminium alloy	Frame Type Freezer Racks	4 x 6	552 x 137 x 340	133 x 133 x 52
99-2215	Stainless steel	Frame Type Freezer Racks	3 x 5	422 x 137 x 284	133 x 133 x 52
99-2216	Stainless steel	Frame Type Freezer Racks	4 x 4	560 x 137 x 229	133 x 133 x 52
99-2220	Stainless steel	Frame Type Freezer Racks	4 x 5	560 x 137 x 284	133 x 133 x 52
99-2224	Stainless steel	Frame Type Freezer Racks	4 x 6	560 x 137 x 339	133 x 133 x 52
99-2225	Stainless steel	Frame Type Freezer Racks	5 x 5	680 x 137 x 284	133 x 133 x 52
99-2230	Stainless steel	Frame Type Freezer Racks	5 x 6	696 x 137 x 342	133 x 133 x 52



## Side Access Drawer Freezer Racks

- Made of corrosion-resistant stainless steel
- Ideal for storage of 1 inch and 2 inch standard size cryogenic boxes
- Fits most standard upright freezers
- Can be customized

Cat #	Material	Description	Capacity (D x H Configuration)	Dimensions(mm) (D x W x H)	Storage box size (mm)
99-5216	Stainless steel	Side Access Drawer Freezer Racks	4 x 4	560 x 140 x 240	133 x 133 x 52
99-5220	Stainless steel	Side Access Drawer Freezer Racks	4 x 5	560 x 140 x 300	133 x 133 x 52
99-5225	Stainless steel	Side Access Drawer Freezer Racks	5 x 5	685 x 140 x 293	133 x 133 x 52
99-5224	Stainless steel	Side Access Drawer Freezer Racks	4 x 6	560 x 140 x 360	133 x 133 x 52



## Vertical Type Freezer Racks

- Made of corrosion-resistant stainless steel or aluminium alloy
- Ideal for storage of 1 inch and 2 inch standard size cryogenic boxes
- Fits most standard upright freezers
- Especially suitable for liquid nitrogen freezing
- Can be customized

Cat #	Material	Description	Capacity (D x H Configuration)	Dimensions (mm) (D x W x H)	Storage box size (mm)
99-62XX	Stainless steel	Vertical Type	1 x X	* x 140 x 140	133 x 133 x 52
96-62XX	Aluminium alloy	Vertical Type	1 x X	* x 139 x 140	133 x 133 x 52
X ( Capacity /L ) 06, 07, 08, 09, 10, 11, 12, 13			* ( Depth /mm ) 338, 394, 450, 506, 562, 618, 674, 730		

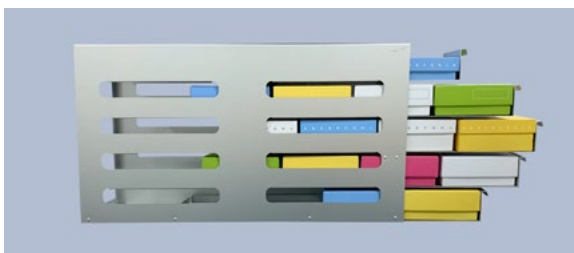

## Sliding Side Drawer Freezer Racks

- Made of high-performance aluminum alloy
- Light weight, convenient operation, and elegant appearance
- Ideal for storage of 1 inch and 2 inch cryogenic boxes and standard freezers
- Handle design enables easy removal from the shelf
- Flanging design reduces scratching
- Can be customized

Cat #	Material	Description	Capacity (D x H Configuration)	Dimensions (mm) (D x W x H)	Storage box size (mm)
96-5216	Aluminium alloy	Sliding Side Drawer Freezer Racks	4 x 4	564 x 141 x 240.2	133 x 133 x 52
96-5220	Aluminium alloy	Sliding Side Drawer Freezer Racks	4 x 5	564 x 141 x 300	133 x 133 x 52



# 8-Channel Screw Cap Capper/Decapper & Scanners



8-Channel

## 8-Channel Screw Cap Capper/Decapper

- Easy-to-use design: Caps or decaps 8 tubes in an individual line  
Convenient operation: Improves processing throughput of manual procedures with automated column-wise decapping and capping in just three seconds
- Optimal torque level: Ensures reproducibility by capping/ decapping all tubes to the optimal torque level
- Ergonomic design: Allows anyone in the lab to cap or decap tubes with a light weight, easy-to-use and ergonomic design
- Extra-long standby time: Enhances the convenience of actual operation
- Low noise: Enables the capping /decapping noise less than 5 decibels

Cat#	Lithium battery capacity	Continual operation	Standby time	8-Channel screw cap capping/Decapping	External dimension(L*W*H)
CKS-1008	5500MA	8H	30 Days	3S	95mm*46mm*255mm



## CryoKING Handheld Scanner

- Infrared scanning individual cryogenic vials to identify barcodes and 2D barcodes accurately
- Ergonomic handheld design
- Compatible with CryoKING Crown biobanking management software
- Collect sample information rapidly and accurately



## CryoKING Scanner-3.0

- Scans one rack in less than 1 second
- Advanced error handling options
- Operates down to -20°C
- Compatible with most cryogenic boxes of major brands
- Project based workflow for easy rack type changes
- Detects missing tubes
- Advanced error handling options

Cat #	Description	Scan Type
CKS-0101	Wired Handheld Scanner Gun	Individual Vial
CKS-1301	AC 100-240V/50Hz/60Hz	Entire Box

# CryoKING Tube Handling System



## >> Features

- Re-array, reformat or cherry pick tubes
- Weigh tubes (tare & gross weights)
- Detect volume with the LevelCheck
- 2D Barcode decoding
- LIMS integration ready
- Work list based operation
- Efficient for both small and large projects
- Label printer and applicator option
- Designed for continuous use and unattended operation
- Encoder based robotics and precision bearings provide the highest reliability
- Integration software toolkits available

## Ordering Information

- Electrical: 110–220 VAC 50/60Hz
- Operating Environment: 10°C to 40°C , 10–90% RH [Standard]; –4°C to 40°C , 10–90% RH [Cold Room Model]
- System Requirements: Windows 10, 8, 7 – 2 GB RAM Recommended – USB 2.0 ports

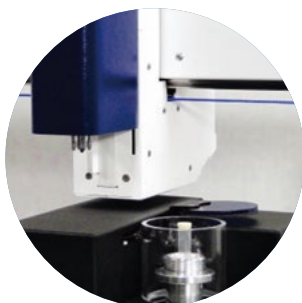

Weigh Tubes

Re-array, reformat tubes



Label Printing and Application

Decode 2D barcodes



Cat #	Capacity	Modules	Dimensions (mm)	Weight
CKS-1520	20 SBS Racks	Standard: Re-array, reformat tubes; Decode 2D barcodes, weigh tubes	72 x 53 x 40 cm	27 kg
CKS-152X	20 SBS Racks	Optional: Level check, DMSO hydration check, label, enclosure	Depend on modules	Depend on modules

# Biobanking Management Software

The CryoKING Crown Biobanking Management Software integrates everything from sample management and storage to packaging and transport into one comprehensive management program. It is the tool of choice for streamlined scientific research and biobanking management.

## >> Features

- Can be accessed through the CryoKING Cloud service, or hosted locally for use on a laboratory's own LAN
- Designed for use with industry-standard equipment and procedures
- Easy-to-use interface allows users to upload and import existing sample data
- Compatible with CryoKING Scanner-1.0 and Scanner-3.0 for entire box of individual 2D-barcoded cryogenic vials
- Currently available in English and Simplified Chinese (more languages coming soon)

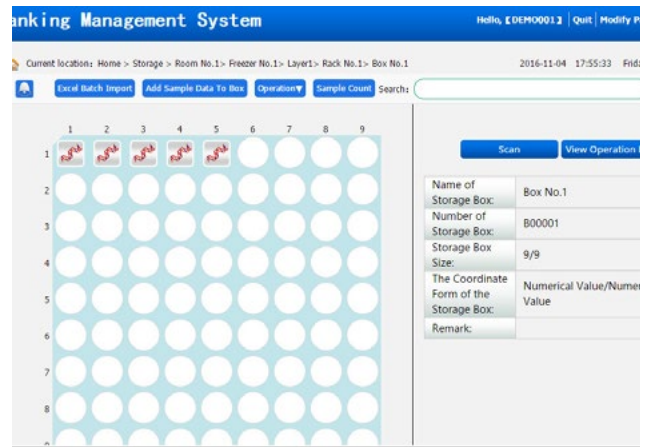
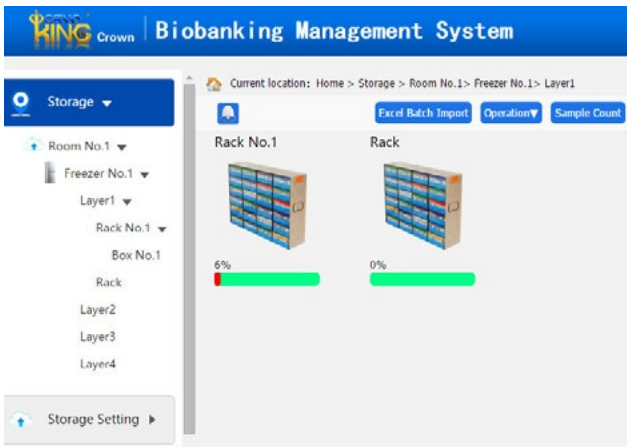

1. Our products (including freezer racks, cryogenic boxes, and cryogenic vials, with more to come) are designed with to be compatible with standard-size equipment and to be suitable for the storage of many types of samples.

2. The Crown visual interface displays a visual representation of every level of a lab's sample storage from freezers to individual samples, allowing users to review their sample storage status at a glance.

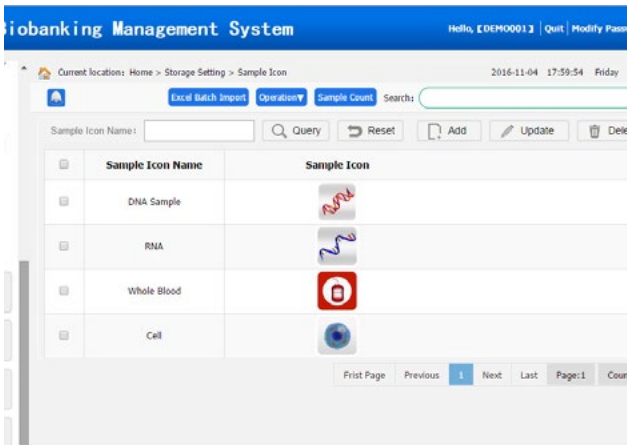

3. Icons and templates can be customized to suit each lab's needs, and custom images can be uploaded for use as icons.

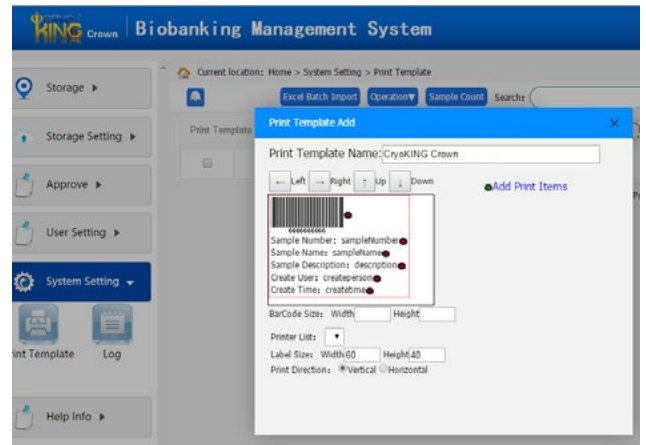

4. Transition seamlessly from your previous system by importing your data into the Crown system using Excel or CSV files.

# Low Temperature Freezers



Suitable for blood banks, hospitals, sanitation and antiepidemic stations and clinics, electronic industries, university laboratories, military industries, pelagic fishery companies, and drugstores.

-164°C Ecryo Freezer

-152°C /-135°C /-105°C Cryo Freezer

-86°C Ultra Low Freezer

-86°C Ultra Low Freezer

-40°C Ultra Low Freezer

-25°C Medical Freezer

Combined Refrigerator &Freezer

2 ~ 8°C Medical Refrigerator

4°C Blood Bank Refrigerator



# Liquid Nitrogen Tanks



Made of high quality stainless steel or durable aluminum; intelligent monitoring system and multi alarms to ensure the safety of samples. Different types can be chosen according to different storage requirements.

Filling Series

Transport Series

Air Transport Series

Special Transport Series

Static Storage Series

Biobank Series

Portable Dewar Series

Laboratory Series





# Cell Culture Series

---

Cell culture involves sampling cells from an organism, placing these cells in an in vitro environment, and observing the growth, reproduction, aging or other processes of the cells. Cell culture has become an important practice in life science research, and plays a central role in the development of the biotechnology industry.

The Biologix Cell Culture Series offers a range of safe and reliable basic supplies for cell transfer, filtering, and other applications.





# Cell Culture Flasks



## >> Features

- Made of high quality medical grade polystyrene
- Available flask sizes include surface areas of 25 cm<sup>2</sup>, 75 cm<sup>2</sup>, or 175 cm<sup>2</sup>
- Plug cap and filter cap options available for all flask sizes
- Plug caps completely isolate the culture from the outside environment
- Filter caps prevent cross-contamination while meeting the requirements for gas exchange
- Short, wide, angled neck design for easy access
- Gamma radiation sterilized
- Non-pyrogenic, non-cytotoxic
- DNase & RNase free, human DNA free

Suitable for open culture conditions, effectively preventing cross-contamination while meeting therequirements for gas exchange in cell and tissue culture

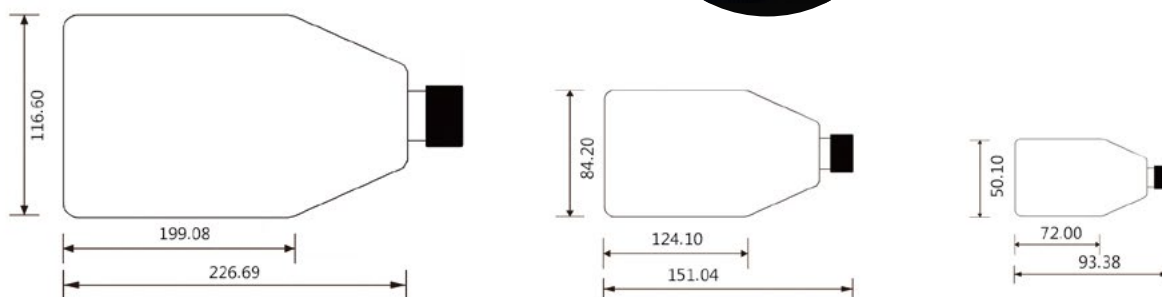

Dimensions = mm

Cat #	Cap Type	Culture Area	Working Volume	Total Volume	Surface Treatment	Sterile	Unit	Total
07-8025	Filter	25cm <sup>2</sup>	7ml	60 ml	Yes	Yes	5 /Bag, 40 Bags/Case	200 /Case
07-8075	Filter	75cm <sup>2</sup>	25ml	250ml	Yes	Yes	5 /Bag, 20 Bags/Case	100 /Case
07-8175	Filter	175cm <sup>2</sup>	50ml	650ml	Yes	Yes	5 /Bag, 8 Bags/Case	40 /Case
07-9025	Plug	25cm <sup>2</sup>	7ml	60ml	Yes	Yes	5 /Bag, 40 Bags/Case	200 /Case
07-9075	Plug	75cm <sup>2</sup>	25ml	250ml	Yes	Yes	5 /Bag, 20 Bags/Case	100 /Case
07-9175	Plug	175cm <sup>2</sup>	50ml	650ml	Yes	Yes	5 /Bag, 8 Bags/Case	40 /Case

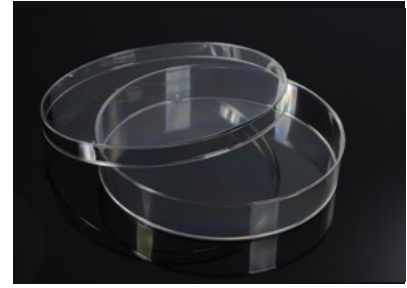
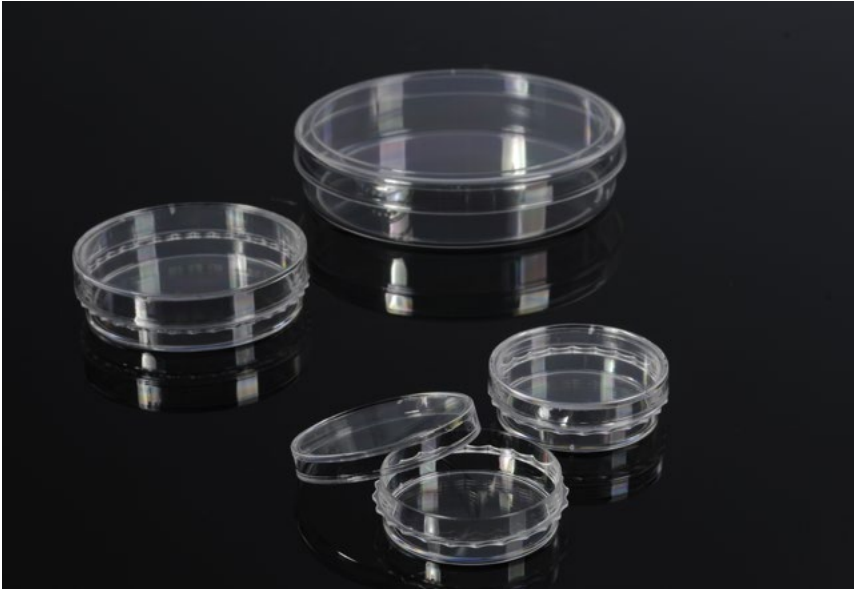

## >> Features

- Made of high quality medical grade polystyrene
- Lid design promotes effective gas exchange
- External grip for easier handling (07-3035 and 07-3060)
- Raised edges for convenient stacking
- Vacuum plasma surface treatment ensures excellent cell adhesion
- Smooth, transparent materials facilitate observation of cells through a microscope
- Electron beam sterilized
- Non-pyrogenic, non-cytotoxic
- DNase & RNase free, human DNA free

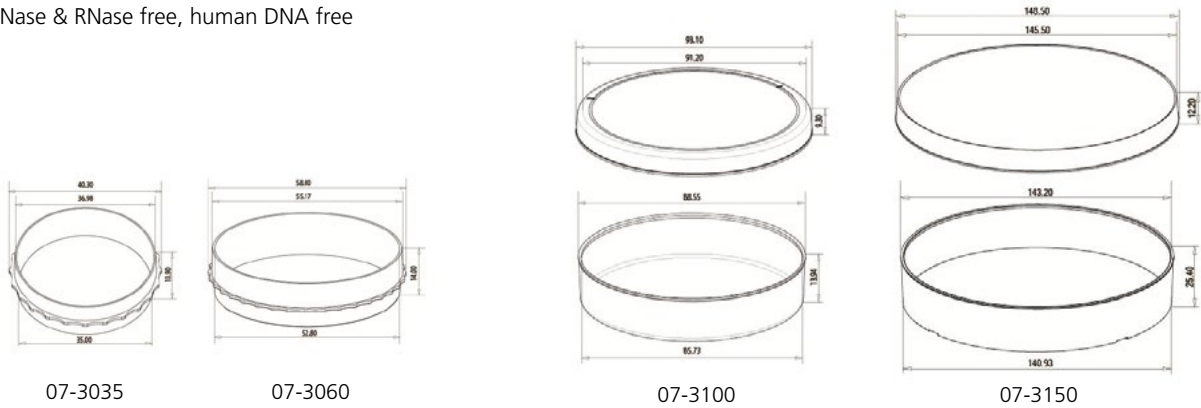

Dimensions = mm

Cat #	Dish style DxH(mm)	Internal Dimensions D x H (mm)	Culture Area	Working Volume	External Grip	Sterile	Unit
07-3035	35.00 x 10.00	34.30 x 9.30	9.40cm <sup>2</sup>	3.00ml	Yes	Yes	10 /Bag, 500 /Case
07-3060	60.00 x 15.00	52.80 x 12.80	21.50cm <sup>2</sup>	5.00ml	Yes	Yes	10 /Bag, 500 /Case
07-3100	90.00 x 20.00	86.26 x 17.70	57.50cm <sup>2</sup>	12.50ml	No	Yes	10 /Bag, 200 /Case
07-3150	150.00 x 25.00	140.20 x 23.30	148.00cm <sup>2</sup>	35.00ml	No	Yes	10 /Bag, 120 /Case

# Cell Culture Plates



## >> Features

- Constructed of prime virgin polystyrene
- Plate cover design minimizes the risk of cross contamination
- Thin-walled well bottoms increase thermal consistency, reducing the edge effect
- Flat well bottoms provide excellent clarity for microscopic examination of samples
- Raised well rim design around each well enables secure sealing and safeguards against evaporation
- Gamma radiation sterilized
- Non-pyrogenic, non-cytotoxic
- DNase & RNase free, human DNA free

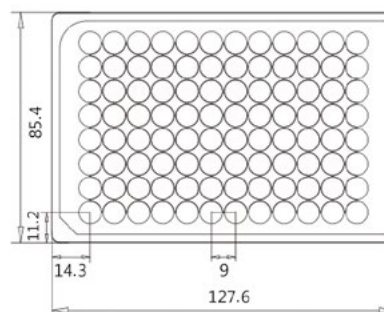
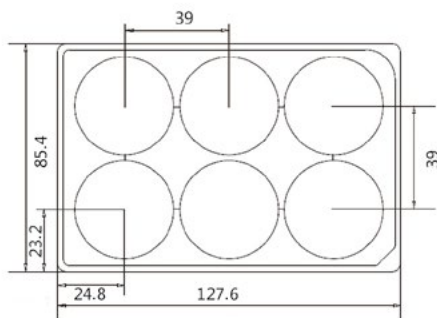

Dimensions = mm

Cat #	Wells	External Dimensions W x L x H (mm)	Well Dimensions D x H (mm)	Culture Area	Working Volume	Sterile	Unit
07-6006	6-well	85.40 x 127.60 x 20.20	35.00 x 17.50	9.6cm <sup>2</sup>	3ml	Yes	1 /Bag, 50 Bags/Case
07-6012	12-well	85.40 x 127.60 x 20.20	21.90 x 17.50	3.8cm <sup>2</sup>	2ml	Yes	1 /Bag, 50 Bags/Case
07-6024	24-well	85.40 x 127.60 x 20.20	15.50 x 17.50	1.9cm <sup>2</sup>	1ml	Yes	1 /Bag, 50 Bags/Case
07-6048	48-well	85.40 x 127.60 x 20.20	9.75 x 17.50	0.75cm <sup>2</sup>	0.5ml	Yes	1 /Bag, 50 Bags/Case
07-6096	96-well	85.40 x 127.60 x 14.40	6.50 x 10.80	0.33cm <sup>2</sup>	0.2ml	Yes	1 /Bag, 50 Bags/Case

# Serological Pipettes

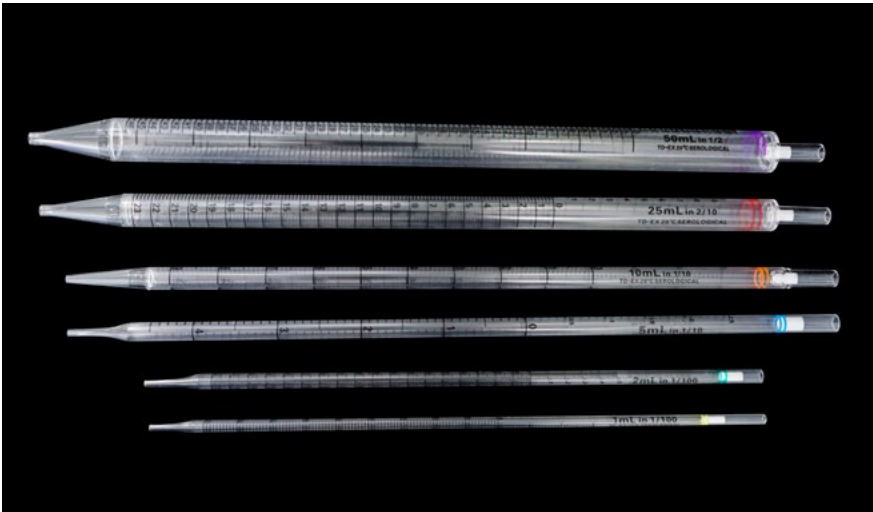

## >> Features

- Constructed of highly transparent prime virgin polystyrene
- Available in 1ml, 2ml, 5ml, 10ml, 25ml, 50ml volumes
- Each volume labeled with a different color for ease of use
- Ascending and descending graduations
- Filter at the top of each pipette prevents damage to pipettors
- Electron beam sterilized
- Non-pyrogenic, non-cytotoxic
- DNase & RNase free, human DNA free

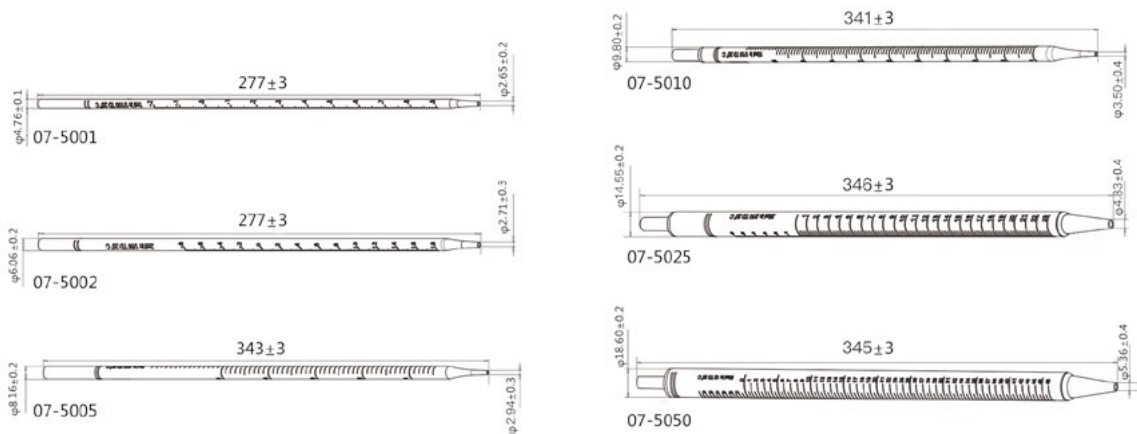

Dimensions = mm

Cat #	Working Volume	Color	Sterile	Unit	Total
07-5001	1.00ml	Yellow	Yes	1 /Bag, 200 Bags/Pack, 4 Packs/Case	800 /Case
07-5002	2.00ml	Green	Yes	1 /Bag, 150 Bags/Pack, 4 Packs/Case	600 /Case
07-5005	5.00ml	Blue	Yes	1 /Bag, 100 Bags/Pack, 4 Packs/Case	400 /Case
07-5010	10.00ml	Orange	Yes	1 /Bag, 100 Bags/Pack, 4 Packs/Case	400 /Case
07-5025	25.00ml	Red	Yes	1 /Bag, 50 Bags/Pack, 4 Packs/Case	200 /Case
07-5050	50.00ml	Purple	Yes	1 /Bag, 40 Bags/Pack, 4 Packs/Case	160 /Case

# Cell Culture Slides

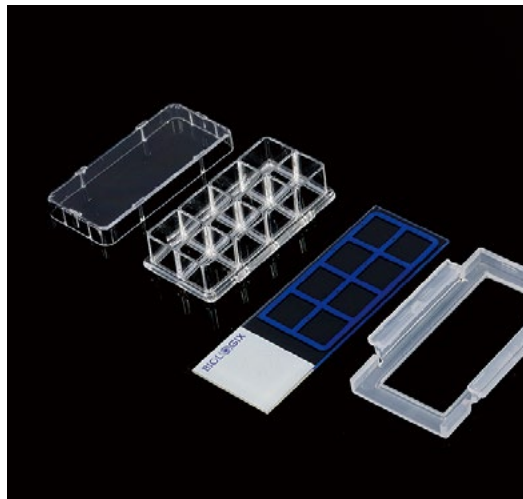

## >> Features

- Easy-to-open, highly transparent slide chambers
- Chamber numbering for convenient sample identification
- Polystyrene chamber piece available with 1, 2, 4, or 8 wells
- Packing trays can be used as incubation racks in CO<sub>2</sub> incubators
- Slide and chamber apparatus can be easily disassembled without damaging samples
- EO Sterilized

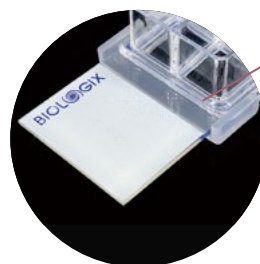
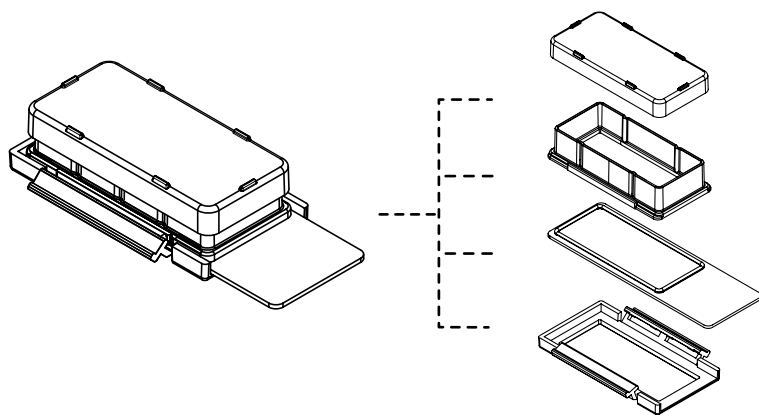

Easy-to-open,  
highly transparent  
slide chambers

Cat #	Material Chamber/Slide/Holder	Wells	Color	Growth Area	Working	Sterile	Unit	Total
07-2101	PS /Glass/PP	1-well	Clear	9.40cm <sup>2</sup>	2.50-5.50ml	Yes	6 /Pack, 2 Packs/Case	12 /Case
07-2102	PS /Glass/PP	2-well	Clear	4.55cm <sup>2</sup>	1.20-2.50ml	Yes	6 /Pack, 2 Packs/Case	12 /Case
07-2104	PS /Glass/PP	4-well	Clear	2.13cm <sup>2</sup>	0.50-1.30ml	Yes	6 /Pack, 2 Packs/Case	12 /Case
07-2108	PS /Glass/PP	8-well	Clear	0.98cm <sup>2</sup>	0.20-0.60ml	Yes	6 /Pack, 2 Packs/Case	12 /Case





## >> Features

- Made of sturdy polypropylene and strong nylon mesh
- Three different pore sizes available: 40µm, 70µm, or 100µm
- Strainers are color-coded according to pore size for convenience
- Fits perfectly into Biologix 50ml Centrifuge Tubes
- Gamma radiation sterilized, non-pyrogenic

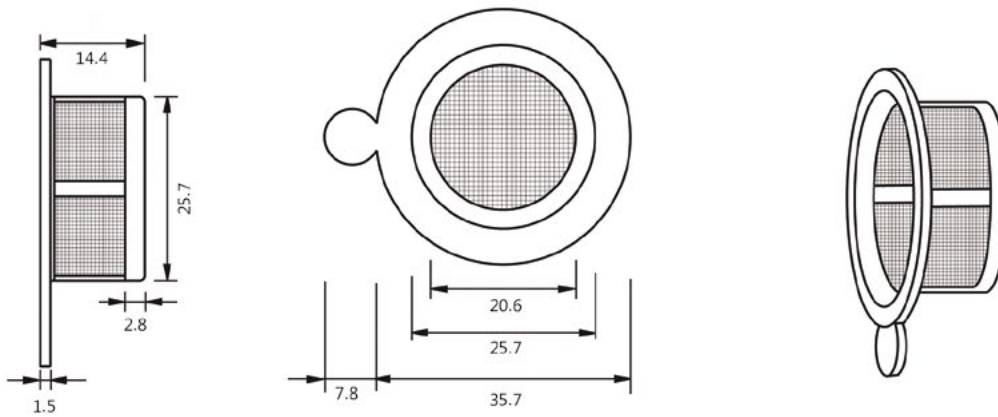

Dimensions = mm

Cat #	Size	Color	Sterile	Package	Unit	Total
15-1040	40µm	Purple	Yes	Individual	1 /Bag, 100 Bags/Case	100 /Case
15-1070	70µm	Orange	Yes	Individual	1 /Bag, 100 Bags/Case	100 /Case
15-1100	100µm	Green	Yes	Individual	1 /Bag, 100 Bags/Case	100 /Case



# Sterile Syringe Filters & Vacuum Units



## >> Features

- Syringe filters are suitable for 1ml~150ml liquid or solution, vacuum units are suitable for 150ml~2L liquid or solution
- Single Use and Gamma Ray pre-sterilized
- Sterile graded 0.2um membrane: LRV > 7 for *Brevundimonas diminuta*, ATCC 19146.
- Non-pyrogenic, low extractables and surfactant-free ensures purity of filtrate.
- Extreme-low Protein Binding <1.5% (PES)
- Excellent Throughput, for faster filtration and more process volume.

Cat #	Description	Unit
08-PES1322R	Syringe filters. Membrane: PES, pore size: 0.22µm, diameter:13mm. Female luer lock + male luer slip. Extreme-low protein binding. Individually packed	100 /Pack, 8 Packs/Case
08-PES2522R	Syringe filters. Membrane: PES, pore size: 0.22µm, diameter:25mm. Female luer lock + male luer slip. Extreme-low protein binding. Individually packed	100 /Pack, 4 Packs/Case
08-PES3022R	Syringe filters. Membrane: PES, pore size: 0.22µm, diameter:30mm. Female luer lock + male luer slip. Extreme-low protein binding. Individually packed	100 /Pack, 4 Packs/Case
08-PES3322S	Syringe filters. Membrane: PES, pore size: 0.22µm, diameter:33mm. Double luer lock. Extreme-low protein binding. Individually packed	100 /Pack, 4 Packs/Case
08-PES3345S	Syringe filters. Membrane: PES, pore size: 0.45µm, diameter:33mm. Double luer lock. Extreme-low protein binding. Individually packed	100 /Pack, 4 Packs/Case
08-PES3322M	Syringe filters. Membrane: PES, pore size: 0.22µm, diameter:33mm. Female luer lock + male luer slip. High pressure resistance. Individually packed	100 /Pack, 4 Packs/Case
08-PES3345M	Syringe filters. Membrane: PES, pore size: 0.45µm, diameter:33mm. Female luer lock + male luer slip. High pressure resistance. Individually packed	100 /Pack, 4 Packs/Case
08-CA3022R	Syringe filters. Membrane: CA, pore size: 0.22µm, diameter:30mm. Female luer lock + male luer slip. High biocompatibility. Individually packed	100 /Pack, 4 Packs/Case
08-CA3045R	Syringe filters. Membrane: CA, pore size: 0.45µm, diameter:30mm. Female luer lock + male luer slip. High biocompatibility. Individually packed	100 /Pack, 4 Packs/Case
09-PES2250	Vacuum filtration unit. Membrane: PES, pore size: 0.22µm, diameter:90mm, funnel volume: 500ml, receiver volume: 500ml	12 /Case
09-PES2250F	Vacuum filtration unit-funnel. Membrane: PES, pore size: 0.22µm, diameter:90mm, funnel volume: 500ml	24 /Case
09-CA2250	Vacuum filtration unit. Membrane: CA, pore size: 0.22µm, diameter:90mm, funnel volume: 500ml, receiver volume: 500ml	12 /Case
09-CA2250F	Vacuum filtration unit-funnel. Membrane: CA, pore size: 0.22µm, diameter:90mm, funnel volume: 500ml.	24 /Case

# Cell Scrapers & Lifters



## >> Features

### Cell Scrapers

- Made of polyethylene
- Available in two sizes: 18cm or 25cm in length,
- Pivoting blade makes precise cutting and scraping movements
- Gamma radiation sterilized, non-pyrogenic

### Cell Lifters

- Made of polyethylene
- One-piece design and chiseled blade provide improved control while minimizing damage to cells
- Gamma radiation sterilized, non-pyrogenic

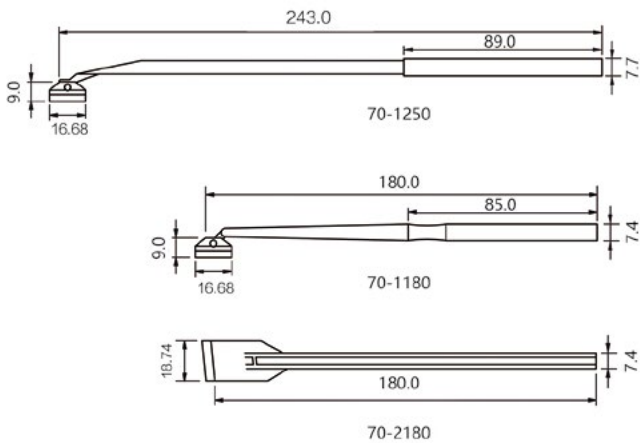

Dimensions = mm

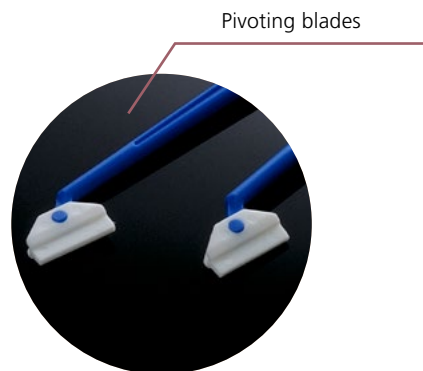

Cat #	Name	Handle Length	Sterile	Package	Unit	Total
70-2180	Cell Lifter	18cm	Yes	Individual	1 /Bag, 100 Bags/Case	100 /Case
70-1180	Cell Scraper	18cm	Yes	Individual	1 /Bag, 100 Bags/Case	100 /Case
70-1250	Cell Scraper	24.3cm	Yes	Individual	1 /Bag, 200 Bags/Case	200 /Case



## PCR Series

---

PCR (polymerase chain reaction) is a technique used in molecular biology to amplify a segment of DNA, and is commonly used in both clinical and research laboratories for many applications, including DNA sequencing, diagnosis of hereditary diseases, and more. The Biologix PCR Series includes a variety of PCR tubes and plates suitable for standard PCR experiments.



## >> Features

- Made of high quality medical grade polypropylene
- Ultra thin-wall tubes provide faster heating and cooling
- High degree of transparency allows for easy observation of samples
- Available with domed caps or flat caps
- Domed caps ensure efficient heat transfer
- Flat caps are ideal for Real-Time PCR (qPCR)
- Unique cap design prevents opening during cycling and incubation stages
- DNase, RNase, and endotoxin free

## Specifications

- Fits most standard thermocyclers
- Can withstand centrifugation of up to 6,000 RCF

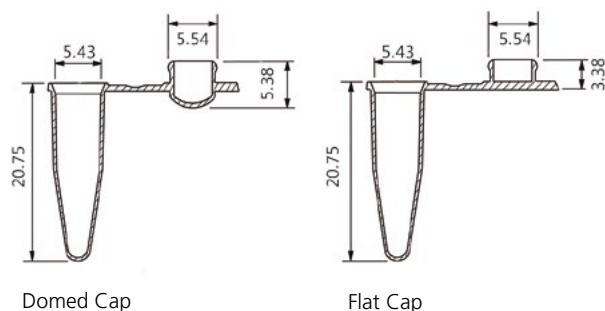

Dimensions = mm

Cat #	Volume	Color	Cap	Sterile	Unit	Total
60-0082	0.2ml	Clear	Flat-top	No	1,000 /Bag/Pack, 10 Packs/Case	10000 /Case
60-0182*	0.2ml	Pink	Flat-top	No	1,000 /Bag/Pack, 10 Packs/Case	10000 /Case
60-0282*	0.2ml	Green	Flat-top	No	1,000 /Bag/Pack, 10 Packs/Case	10000 /Case
60-0382*	0.2ml	Blue	Flat-top	No	1,000 /Bag/Pack, 10 Packs/Case	10000 /Case
60-0482*	0.2ml	Yellow	Flat-top	No	1,000 /Bag/Pack, 10 Packs/Case	10000 /Case
60-0002	0.2ml	Clear	Dome-shaped	No	1,000 /Bag/Pack, 10 Packs/Case	10000 /Case
60-0102*	0.2ml	Pink	Dome-shaped	No	1,000 /Bag/Pack, 10 Packs/Case	10000 /Case
60-0202*	0.2ml	Green	Dome-shaped	No	1,000 /Bag/Pack, 10 Packs/Case	10000 /Case
60-0302*	0.2ml	Blue	Dome-shaped	No	1,000 /Bag/Pack, 10 Packs/Case	10000 /Case
60-0402*	0.2m	Yellow	Dome-shaped	No	1,000 /Bag/Pack, 10 Packs/Case	10000 /Case

\* Call for details.

# 8-Strip PCR Tubes

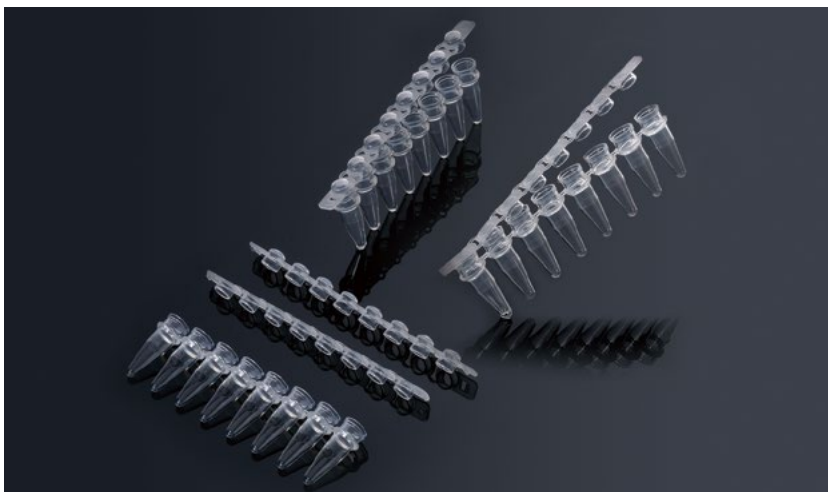

## >> Features

- Made of high quality medical grade polypropylene
- Ultra thin-wall tubes provide faster heating and cooling
- High degree of transparency allows for easy observation of samples
- Available with domed caps or flat caps
- Domed caps ensure efficient heat transfer
- Flat caps are ideal for Real-Time PCR (qPCR)
- Unique cap design prevents opening during cycling and incubation stages
- DNase, RNase, and endotoxin free

## Specifications

- Fits most standard thermocyclers
- Can withstand centrifugation of up to 6,000 RCF
- Packaged in resealable bags

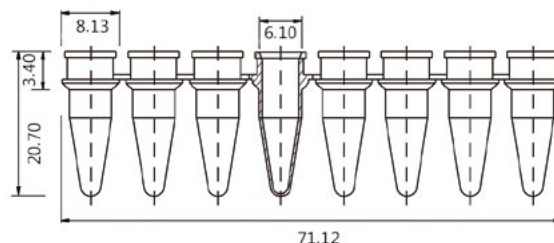

Dimensions = mm

Cat#	Volume	Color	Cap Type	Sterile	Unit
60-0088	0.2ml	Clear	Flat	No	125 Strip Tubes+125 Strip Caps/Bag/Pack, 10 Packs/Case; 1250 sets/Case
60-0188*	0.2ml	Pink	Flat	No	125 Strip Tubes+125 Strip Caps/Bag/Pack, 10 Packs/Case; 1250 sets/Case
60-0288*	0.2ml	Green	Flat	No	125 Strip Tubes+125 Strip Caps/Bag/Pack, 10 Packs/Case; 1250 sets/Case
60-0388*	0.2ml	Blue	Flat	No	125 Strip Tubes+125 Strip Caps/Bag/Pack, 10 Packs/Case; 1250 sets/Case
60-0488*	0.2ml	Yellow	Flat	No	125 Strip Tubes+125 Strip Caps/Bag/Pack, 10 Packs/Case; 1250 sets/Case
60-0008	0.2ml	Clear	Domed	No	125 Strip Tubes+125 Strip Caps/Bag/Pack, 10 Packs/Case; 1250 sets/Case
60-0108*	0.2ml	Pink	Domed	No	125 Strip Tubes+125 Strip Caps/Bag/Pack, 10 Packs/Case; 1250 sets/Case
60-0208*	0.2ml	Green	Domed	No	125 Strip Tubes+125 Strip Caps/Bag/Pack, 10 Packs/Case; 1250 sets/Case
60-0308*	0.2ml	Blue	Domed	No	125 Strip Tubes+125 Strip Caps/Bag/Pack, 10 Packs/Case; 1250 sets/Case
60-0408*	0.2ml	Yellow	Domed	No	125 Strip Tubes+125 Strip Caps/Bag/Pack, 10 Packs/Case; 1250 sets/Case

\* Call for details.



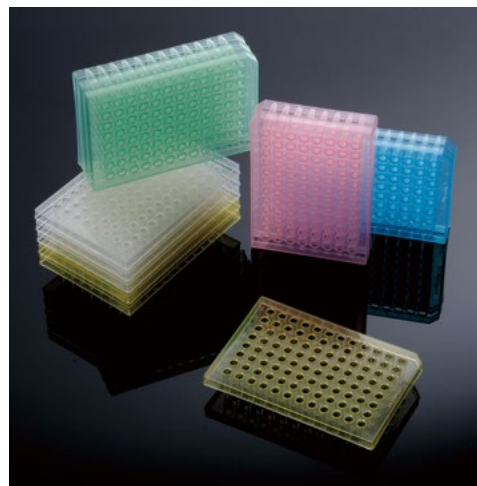

## >> Features

- Made of high quality medical grade polypropylene
- Ultra-thin tube walls with uniform thickness for accelerated heat transfer, shorter cycle times, and more consistent results
- Alphanumeric well labeling for convenient identification
- DNase, RNase, and endotoxin free

## Specifications

- Fits most standard thermocyclers
- Can withstand centrifugation of up to 6,000 RCF



Half-skirted plates are easy to insert and remove

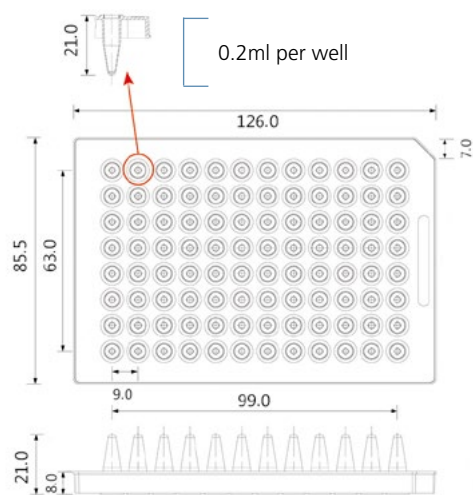

Dimensions = mm

Cat #	Well	Skirt	Color	Sterile	Unit	Total
60-0056	96-well	Half-Skirted	Clear	No	5 /Bag, 5 Bags /Pack, 4 Packs/Case	100 /Case
60-0156*	96-well	Half-Skirted	Pink	No	5 /Bag, 5 Bags /Pack, 4 Packs/Case	100 /Case
60-0256*	96-well	Half-Skirted	Green	No	5 /Bag, 5 Bags /Pack, 4 Packs/Case	100 /Case
60-0356*	96-well	Half-Skirted	Blue	No	5 /Bag, 5 Bags /Pack, 4 Packs/Case	100 /Case
60-0456*	96-well	Half-Skirted	Yellow	No	5 /Bag, 5 Bags /Pack, 4 Packs/Case	100 /Case

\* Call for details.

# PCR Plate Compatibility

## Biologix Plates ▶

60-0056  
(Half-Skirted)

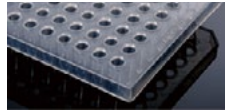

Brand	Model	
<b>Real Time PCR Thermal Cyclers</b>		
Applied Biosystems	7000	✓
	7300	✓
	7500	✓
	7700	✓
	7900HT	✓
	StepOne	
BioRad	iCycler	✓
	MyiQ	
	iQ5	✓
Eppendorf	MasterCycler ep Realplex	
MJ Research	Opticon	
	Opticon 2	
	Chromo 4	
	MX-4000	
	MX-3000	
Techne	Quantica	
<b>PCR Thermal Cyclers</b>		
Applied Biosystems	Veriti	✓
	9600	✓
	9700	✓
	7800FAST	
	2720	✓
Biometra	Uno	✓
	Uno II	✓
	T1 Thermal Cycler	✓
	Tgradient	✓
	Trobot	✓
BioRad	iCycler	✓
MyCycler		✓
Corbett Research	PalmCycler 96	✓
	PalmCycler 384	
Eppendorf	Mastercycler	✓
	Mastercycler ep	✓
	Mastercycler M384	
Flexi	Gene	✓
	Genius	✓

## Biologix Plates ▶

60-0056  
(Half-Skirted)

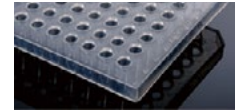

Brand	Model	
Ericom	Single Block	✓
	Twin Block	✓
	Deltacycler I	✓
ThermoHybaid	PCR Sprint	✓
	PCR Express	✓
	Multiblock System	✓
	Touchdown	✓
	Omnigene	✓
	Omn-E	✓
	pxe	✓
	px2	✓
MJ Research	PTC-100	✓
	PTC-200	✓
	PTC-225 Tetrad	✓
	Dyad/Disciple	✓
MWG	Primus 96	✓
	Primus 384	
Stratagene	Robocycler	
TaKaRa	TP240	
	TP3000	✓
Techne	Touchgene Gradient (TC512)	✓
	Genius (TC412)	✓
	Touchgene X	✓
<b>Sequencers</b>		
Applied Biosystems	3100	✓
	3130	✓
	3700	✓
	3730/3730x	✓

This chart is intended only as a general guide. Compatibility may vary based on your particular configuration and features. For further help with product selection, please contact us.

FOR TECHNICAL INFORMATION, VISIT [WWW.BIOLOGIXGROUP.COM](http://WWW.BIOLOGIXGROUP.COM)

# Microbiology Series

---

Microbiology is the study of microbial morphology, physiology, biochemistry, genetic variation, and more. It plays an important role in the study of genetic engineering, as well as disease control and prevention. Our Microbiology Series of products covers all your basic microbiology supply needs.



# Petri Dishes

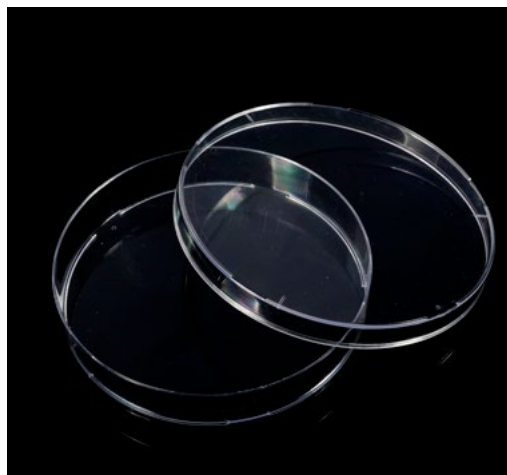

## >> Features

- Made of medical grade polystyrene
- Highly transparent for microscopic analysis
- Three sizes available: 60mm, 90mm, or 150mm in diameter
- 66-1701 fit automatic systems
- Vented lid for better gas exchange
- Dishes are stackable
- EO Sterile

Vents for gas exchange

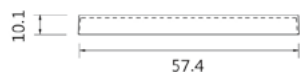
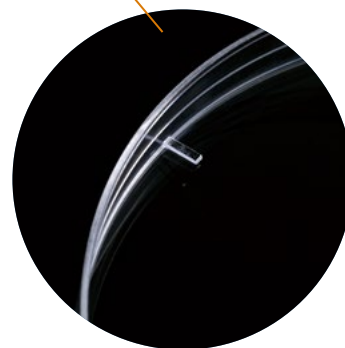

66-1560

66-1501

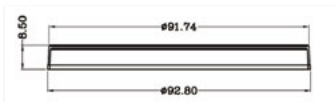

66-1701

Dimensions = mm

Cat #	Size (mm)	Color	Sterile	Unit	Total
66-1560	60x15	Clear	Yes	10 /Bag, 50 Bags/Case	500 /Case
66-1501	90x15	Clear	Yes	10 /Bag, 50 Bags/Case	500 /Case
66-1701	90x17	Clear	Yes	10 /Bag, 50 Bags/Case	500 /Case
66-1515	150x15	Clear	Yes	10 /Bag, 20 Bags/Case	200 /Case



# Inoculating Loops & Needles



## >> Features

- Made of medical grade polystyrene
- Loops available in 1 $\mu$ L and 10 $\mu$ L sizes
- The opposite end of each loop can be used as a needle
- Needles are suitable for removal of single-colony specimens
- Gamma radiation sterilized, non-pyrogenic
- Packaged in resealable bags

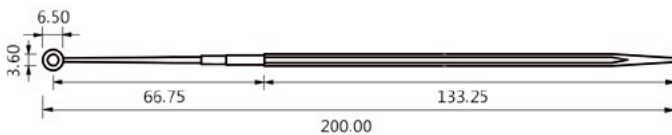

65-0010

Can be used as needles

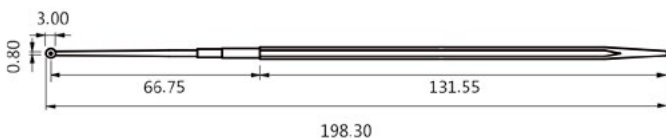

65-0001

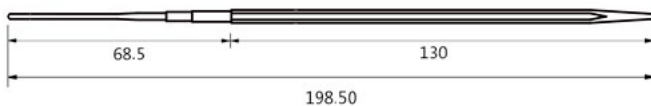

65-0002

Dimensions = mm

Cat #	Size	Description	Color	Sterile	Unit	Total
65-0001	1 $\mu$ L	Loops	Blue	Yes	25 /Bag, 40 Bags/Case	1000 /Case
65-0010	10 $\mu$ L	Loops	Orange	Yes	25 /Bag, 40 Bags/Case	1000 /Case
65-0002	-	Needles	Yellow	Yes	25 /Bag, 40 Bags/Case	1000 /Case



# Cell Spreaders

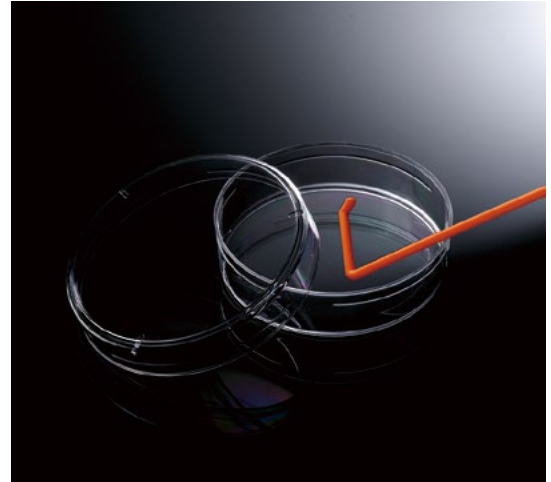
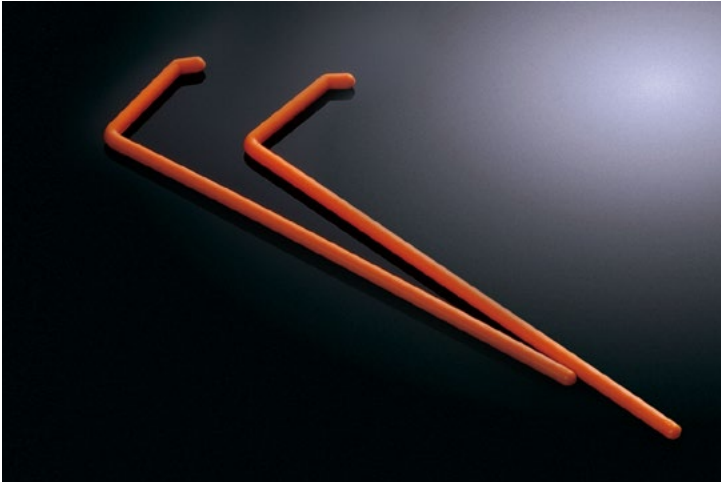

## >> Features

- Polystyrene
- Smooth surface quality and angled end reduce the risk of damaging the culture medium
- L-shape allows application on the entire Culture Dish or plate surface
- Two package options: individually wrapped (sterile), or 10 per bag (sterile, resealable)
- Gamma radiation sterilized



Individually plastic packaging



Zip-seal packaging

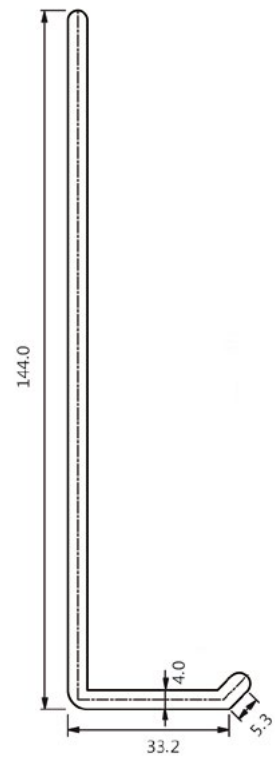

Dimensions = mm

Cat #	Color	Sterile	Unit	Total
65-1001	Orange	Yes	1 /Bag, 500 Bags/Case	500 /Case
65-1010	Orange	Yes	10 /Bag, 50 Bags/Case	500 /Case

A close-up photograph of a scientist in a laboratory setting. The scientist is wearing a white lab coat, a light blue hairnet, a white surgical mask, and white gloves. They are holding a test tube with a blue cap. The background is a blurred laboratory environment.

## Drosophila Culture

---

Drosophila Culture is the culture of *Drosophila melanogaster* fruit flies, which is a common practice in the fields of genetics and developmental biology, due to the convenience of raising *D. melanogaster*, its rapid breeding rate, and the ease with which its morphology can be identified. Our Drosophila Culture Series includes vials, bottles, and foam plugs in bulk or tray packaging.

# Drosophila Vials



## >> Features

- Made of premium grade polystyrene
- Glass-like clarity for sample observation
- Disposable vials are a safe and cost-effective alternative to glass vials
- Narrow or wide vials available
- Both narrow and wide vials are available in bulk or tray packaging
- Tray packs are great for quick, effortless filling of vials



51-0500



51-0800

Dimensions = mm

Your can put your logo here



Cat #	Description	Dimensions (mm)	Sterile	Packaging	Unit	Total
51-0500	Narrow	25 x 95	No	Bulk	25 /Bag, 20 Bags/Case	500 /Case
51-0501	Narrow	25 x 95	No	Tray	100 /Tray, 5 Trays/Case	500 /Case
51-0800	Wide	28.5 x 95	No	Bulk	25 /Bag, 20 Bags/Case	500 /Case
51-0801	Wide	28.5 x 95	No	Tray	100 /Tray, 5 Trays/Case	500 /Case



>> **Features**

- Made of clear polypropylene
- Autoclavable
- Transparent bottle with square bottom
- Firm, stiff neck for easier handling

Molded graduations

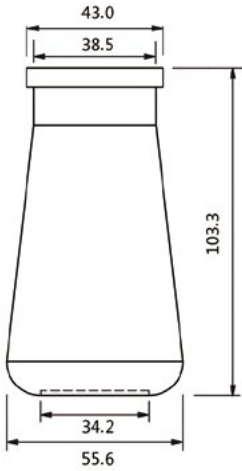

Dimensions = mm

Cat #	Sterile	Packaging	Unit	Total
51-17720	No	Bulk	200 /Bag, 1 Bag/Case	200 /Case
51-17721	No	Tray	25 /Tray, 8 Trays/Case	200 /Case

# Drosophila Plugs

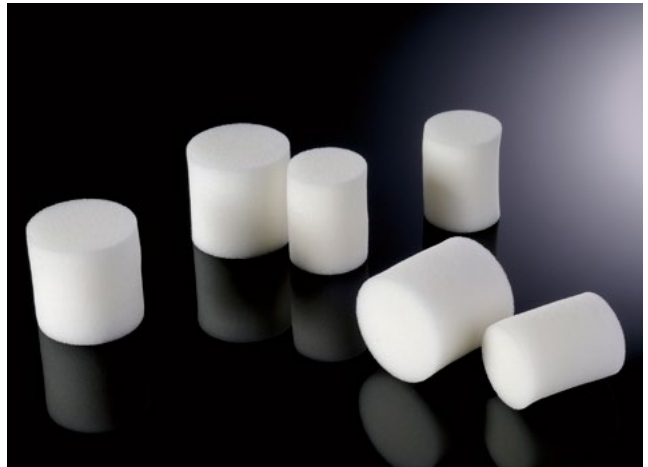

## >> Features

- Made of high density foam
- Causes minimal shedding and reduces evaporation
- Maintains tight fit after repeated use and removal
- Fits Biologix Drosophila vials and bottles

Flat surface accepts can be marked



51-0505



51-0805



51-17725

Cat #	Applied #	Fits	Sterile	Unit	Total
51-0505	51-0500/0501	Narrow Drosophila Vials	No	100 /Bag, 10 Bags/Case	1000 /Case
51-0805	51-0800/0801	Wide Drosophila Vials	No	100 /Bag, 10 Bags/Case	1000 /Case
51-17725	51-17720/17721	Drosophila Bottles	No	50 /Bag, 20 Bags/Case	1000 /Case





# Sample Collection and Detection Products

Biologix supplies various sample collection and detection tools of complete specifications. Suitable for the collection, transportation, preservation, and detection of human samples and environment samples.





## Instruments

---

In addition to consumable lab supplies, laboratory instruments are also important tools for life science research. High-quality lab instruments can greatly improve research efficiency and ensure precise and accurate results. Biologix now supplies small laboratory instruments for a wide variety of applications, including liquid handling, mixing, PCR, centrifuging, electrophoresis, and more.



## dPette Digital Pipette

### Features

- Comprehensive range of liquid handling protocols
- Three aspiration/dispensing speeds
- Motor-drive with built-in error control
- Efficient lithium-ion rechargeable battery
- Autoclavable lower barrel



## Micro PettePlus Pipettes

### Features

- Convenient one-handed operation
- Fully autoclavable
- Compatible with most standard pipette tips

### Pipette Stand (01-2306)

- Holds up to six single- or multi-channel pipettes

Cat #	Type	Channels	Volume Range ( $\mu\text{L}$ )	Tip Volume
01-241X	dPette Digital Pipette	1	0.5-10 $\mu\text{L}$	0.01 $\mu\text{L}$
01-242X	dPette Digital Pipette	1	5-50 $\mu\text{L}$	0.1 $\mu\text{L}$
01-243X	dPette Digital Pipette	1	30-300 $\mu\text{L}$	1 $\mu\text{L}$
01-244X	dPette Digital Pipette	1	100-1000 $\mu\text{L}$	5 $\mu\text{L}$
01-2101	MicroPette Plus Pipettes	1	0.5-10 $\mu\text{L}$	0.1 $\mu\text{L}$
01-2104	MicroPette Plus Pipettes	1	10-100 $\mu\text{L}$	1 $\mu\text{L}$
01-2102	MicroPette Plus Pipettes	1	20-200 $\mu\text{L}$	1 $\mu\text{L}$
01-2110	MicroPette Plus Pipettes	1	100-1000 $\mu\text{L}$	5 $\mu\text{L}$
01-2115	MicroPette Plus Pipettes	1	1000-5000 $\mu\text{L}$	50 $\mu\text{L}$
01-2112	MicroPette Plus Pipettes	1	0.1-2.5 $\mu\text{L}$	0.05 $\mu\text{L}$
01-2122	MicroPette Plus Pipettes	1	2-20 $\mu\text{L}$	0.5 $\mu\text{L}$
01-2155	MicroPette Plus Pipettes	1	5-50 $\mu\text{L}$	0.5 $\mu\text{L}$
01-2801	MicroPette Plus Pipettes	8	0.5-10 $\mu\text{L}$	0.1 $\mu\text{L}$
01-2805	MicroPette Plus Pipettes	8	5-50 $\mu\text{L}$	0.5 $\mu\text{L}$
01-2830	MicroPette Plus Pipettes	8	50-300 $\mu\text{L}$	5 $\mu\text{L}$

# Liquid Handling



## Levo ME Pipette Filler

### Features

- Ergonomic shape and intuitive operation
- Pressure-sensitive buttons: increasing pressure increases aspiration/dispensing speed
- Autoclavable hydrophobic filter prevents over-aspiration
- LED light indicates aspiration/dispensing, charging, and low battery

Cat #	Type	Aspiration Speeds	Dispensing Speeds	Battery Life	Compatible Pipette Types
01-221X	Levo ME	aspirates 25mL of water in < 7 seconds	gravity dispensing	8+ hours of intermittent use	glass or plastic pipettes (0.1-100mL), Pasteur pipettes



## Levo Plus Pipette Filler

### Features

- Six aspiration and dispensing speeds
- LCD display shows speed settings and remaining battery life
- Efficient lithium-ion battery can last for up to 8 hours of intermittent use
- Integral, autoclavable silicone adapter suits use with 0.1-100 mL pipettes

Cat #	Type	Aspirate Speeds	Dispense Speeds	Battery Life	Compatible Pipette Types
01-220X	Levo Plus	25ml < 5s (8 shift)	Motor (6 shift) / Gravity	8+ hours of intermittent use	glass or plastic pipettes (0.1-100mL), Pasteur pipettes





## SAFEVAC Vacuum Aspiration System

### Features

- Integrated pump with adjustable vacuum control
- Self-closing connectors for quick installation and dismantling, prevention of drips, and containment of aerosols
- Liquid level sensor prevents overflow
- Single-channel and multi-channel nozzles and other accessory options available

Cat #	Vacuum range	Pump flow rate	Dimensions [W x D x H]	Weight	Input voltage	Bottle volume
01-270X	0 - 600 mbar	1-15 ml/s	180 x240 x 450mm	3 kg	100-240 VAC, 50/60 Hz	4L



## Laboratory Fluid Collection System

### Features

- Filmed inner wall
- Connection type: Can be connected with fluid instruments of various brands
- Funnel type: Equipped with the valve funnel
- High sealing performance
- Equipped with super efficient filter with connector
- Optional: Liquid level alarm

Cat #	Product	Description	Unit
05-2720	Connection type	One 20L security bucket with inner film , One inner cover, One outer cover, One set of liquid-phase connector, One set of efficient filter connector, One inorganic or organic filter	1 Set/Case
05-2721	Funnel type	One 20L security bucket with inner film , One inner cover, One outer cover, One funnel with a cover, One set of efficient filter connector, One inorganic or organic filter	1 Set/Case
05-2791	Super efficient filter	Inorganic chemical filter	1 Set/Case
05-2792	Super efficient filter	Organic chemical filter	1 Set/Case
05-2793	Liquid lever alarm	Tactile liquid lever alarm	1 Set/Case
05-2797	Liquid carrying cart(standard)	Adjustable size; one cart and one tray	1 Set/Case
05-2798	Liquid carrying cart(intelligent)	Adjustable size; one cart and one tray; equipped with intelligent module	1 Set/Case



# Stirrers



## Classic Magnetic Stirrer

### Features

- Powerful rare-earth permanent magnet
- PET stirring plate provides excellent chemical resistance
- Stand included



## FlatSpin Magnetic Stirrer

### Features

- Ultra-flat, space-saving design
- Automatic rotation-reversing stirring for better mixing results
- Slip-resistant and stable



## Magnetic Stirrer Hotplate

### Features

- Digital control system
- ABS casing is fire-retardant and resistant to weak acids and bases
- Ceramic-coated stainless steel hotplate is chemically resistant and scratch-proof
- Safety feature: HOT caution indicator is displayed at 50°C and above



## EcoStir Square Plate Magnetic Stirrer

### Features

- Compact design with small footprint, 12V voltage available for mobile labs.
- Square work plate supports 1.5L stirring capacity
- Holder with clamp for pH electrode or another sensor
- Default PET top provides excellent chemical resistance
- Extra colorful stickers satisfy DIY design by yourself
- Maintenance free brushless DC moto

Cat #	Type	Stirring plate size [mm]	Motor input rating [W]	Motor output rating [W]	Max. stirring quantity [L, H <sub>2</sub> O]	Speed range [rpm]	Overheating Protection [°C]
01-330X	Classic	Ø 120	7.2	1.2	1.5	300-2000	-
01-320X	FlatSpin	Ø 90	5	3	0.8	15-1500	-
01-310X	Hotplate	Ø 135	5	3	3	100-1500	320
01-330XA	EcoStir	Ø 120	7.2	1.2	1.5	300-2000	5-40



## Vortex Mixer

### Features

- Orbital mixing movement
- Touch and continuous operation settings
- Cast aluminum base and specially designed vacuum suction feet keep the mixer stable
- Various adapters and accessories available for use with tubes of different sizes ( $\Phi 6\text{mm}$ ,  $\Phi 10\text{mm}$ ,  $\Phi 12\text{mm}$ ,  $\Phi 16\text{mm}$ ,  $\Phi 20\text{mm}$  test tubes and vessels  $<99\text{mm}$  in diameter)



Classic Rotators (axial) 01-130X



Classic Rotators (radial) 01-120X

## Classic Rotators

### Features

- End-over-end rotation
- Compact, space saving design
- Various adapters available for use with 1.5mL-50mL tubes

Cat #	Type	Speed range [rpm]	Operation mode	Voltage [V]	Power [W]
01-110X	Vortex Mixer	0-2500	Touch operation/Continuous	110-120/220-230	60
01-120X	Classic Rotator	0-80	Continuous	100-240	20
01-130X	Classic Rotator	0-80	Continuous	100-240	20

# Shakers

## LED Digital Orbital and Linear Shaker



### Features

- Electronic adjustment of speed and timer
- Double LEDs for independent display of time and speed
- Speed range of 40-200rpm
- Fixed board face, max. load capacity is 2kg with platform
- Continuous operation (endless)
- Electronic time switching clock: 1min-19h59min
- Wide range of platforms for use with a variety of vessels
- Work plate dimension (WxD): 268x268mm
- Max. load capacity (with platform): 2kg
- Timer display: LED
- Time settings range: 1min-19h59min
- Power: 20W
- Motor input power: 20W
- Motor output power: 16W
- Dimension (WxDxH): 294x348x123mm
- Weight: 3.1kg
- Permissible ambient temperature and humidity: 5-40°C ,80%RH

Cat #	Orbital diameter	Speed range	Speed display	Motor type	Protection class	Voltage
01-621XA	20mm	40-200rpm	LED	DC motor	IP21	100-240V,50/60HZ



## Gradient Thermocycler

### Features

- Thermal gradient: program different temperatures across different areas of the heating block
- Consistent and uniform sealing across entire heating block
- Intuitive touch-screen user interface



## Thermocycler

### Features

- Consistent and uniform sealing across entire heating block
- Intuitive touch-screen user interface

Cat #	Type	Heating Temperature Range [°C]	Temperature Display Accuracy [°C]	Max. Heating/Cooling Rate [°C/s]	Gradient Temperature Setting Range [°C]	Gradient Range [°C]
01-700X	Gradient Thermocycler	4-99	0.1	3	30-99	1-42
01-710X	Thermocycler	4-99	0.1	3	-	-

# Centrifuges



## Palm Micro Centrifuge

### Features

- Quick acceleration and deceleration
- Rotors for microcentrifuge tubes, PCR tubes, and PCR 8-strip tubes included.
- Quiet, low-noise design

Cat #	Type	Speed Range [rpm]	Max. RCF [xg]	Rotor Capacity
01-800X	Palm Micro Centrifuge	7000	2680	0.2ml/0.5ml/1.5ml/2ml x 8; 0.2ml PCR tubes x 16 or 0.2ml PCR 8-strips x 2



## Mini and Mini-Plus High Speed Centrifuges

### Features

- Brushless DC motor quickly accelerates rotor to the set speed
- Rotors are designed for 1.5ml and 2ml microcentrifuge tubes; adapters for 0.2ml and 0.5ml tubes are also available

### Specifications

- 01-821X (Mini-Plus) with 01-8291 plastic rotor kit\*
- Low noise: 54dB; delivers fast acceleration and deceleration

Cat #	Type	Speed Range [rpm]	Max. RCF [xg]	Rotor Capacity	Speed Accuracy [rpm]	Temperature Range [°C]
01-821X	Mini High Speed Centrifuge	500-15000; increment: 100	15100; increment: 100	0.2ml/0.5ml/ 1.5ml/2.0ml x 12	±20	N/A





## High Speed Micro-Centrifuge

### Features

- Bio-safe rotor prevents sample overflow and ensures samples do not leak during the centrifuging process
- High strength aluminum alloy rotor is autoclavable and highly durable
- Four different rotors are available, assembled with 1.5ml/2ml x 24

Cat #	Type	Speed Range [rpm]	Max. RCF [xg]	Rotor Capacity	Speed Accuracy [rpm]	Temperature Range [°C]
01-830X	High Speed Micro-Centrifuge	200-15000; increment:10	21380; increment: 10	5mlx18; 0.2ml/0.5ml/ 1.5ml/2ml x 24; 0.5ml x 36;PCR8 x 4	±20	N/A

## High-speed Refrigerated Micro Centrifuge

### Features

- Centrifuge chamber door with automatic adsorption door lock design, can be closed with a single finger.
- Precooling, the compressor will automatically start cooling as long as the set temperature is lower than the ambient temperature.
- Sound indicator to prompt that the upper cover is closed to maintain the temperature inside the chamber, after centrifugation.
- Advanced R290 flurine free refrigerant ,low caron and environmental protection.
- Maximum rotation speed can be achieved even at 4°C .
- Up to 9 program storage capacity according to experimental needs.
- Biosafety rotor, three-layer seal for biosafety.
- High-strength aluminum alloy, three layered biosafety to withstand numerous high temperature and high pressure sterilizations.
- Five rotors with 0.2ml, 0.5ml, 1.5ml, 2ml and 5ml centrifuge tubes/PCR tubes capacity.
- An external condensation tank prevents condensate within the centrifuge chamber.
- Other functions: Rotation speed/RCF switchover, inching operation, running process indicator, sound alert. Acceleration/deceleration in 9 steps, program storage capacity.



Cat #	Type	Max. Speed	Max. RCF	Rotor	Temperature setting
01-832X	High-speed Refrigerated Micro Centrifuge	15,000rpm (200-15,000rpm) in 100rpm increments.	21,380xg, step: 10xg	1.5/2mLx24, 0.5mLx36, PCR8x4, 5mLx12, 5mLx18	30s-99 min; HOLD (continuous running)

# Centrifuges



## Clinical Centrifuge

### Features

- Max. speed 4000rpm.
- Rotor speed can be set in RPM/RCF, with 3 programs storage capacity for routine applications.
- Max. capacity 50ml×4, Adapt to different sizes of blood collection tubes and centrifuge tubes suitable for swing out rotor and angle rotor. Automatic internal diagnosis and self-detection.
- Maintenance-free brushless DC motor.
- Noise: ≤62dB(A)
- Power: Single phase, 100V-240V, 50Hz/60Hz.



## Clinical Centrifuge

### Features

- Speed range of 300-4000rpm.
- 3 programs storage capacity for routine applications.
- Automatic internal diagnosis.
- Maintenance free brushless DC motor.
- Noise: ≤60dB(A)
- Power: Single phase, 100V-240V, 50Hz/60Hz

Cat #	Type	Speed range	Max. RCF	Rotor	Speed accuracy
01-860X	Clinical Centrifuge	500-4000rpm increment: 100rpm	2500×g	Swing6×15ml Swing4×50ml Angle24×15ml, Angle12×10ml/8×15ml	±100rpm
01-870X	Clinical Centrifuge	300-4000rpm increment: 100rpm	1900×g	Angel8×15ml(Default), Angel10ml×12	±100rpm



## Dry Bath Incubator

### Features

- A broad temperature range, from room temperature to 120°C
- Continuous and timed operation settings
- Over-temperature protection
- Various interchangeable heating blocks are available (0.2ml x 54, 0.5ml x 40, 1.5/2ml x 40, 5/15ml x 28, 50ml x 8, 0.2ml+0.5ml+1.5/2ml, 96 or 384 well plate)

Cat #	Type	Functions	Temperature uniformity [°C]	Overheating protection	Max heating rate [°C/min]
01-910X	Dry Bath Incubator	Heating	Max ± 0.5	140 °C	5.5



## Hot/Cold Dry Bath Incubator

### Features

- Excellent temperature control system
- Can maintain hot or cold temperatures
- Supports creating and saving custom operation programs
- Various interchangeable heating blocks are available (24 x 0.5ml, 24 x 1.5ml, 24 x 2ml, 8 x 5ml, 8 x 15ml, 4 x 50ml, well plate, 0.2 x 96 PCR plate)

Cat #	Type	Functions	Temperature range	Temperature control accuracy [°C, at 20–45°C]	Max heating rate [°C/min]
01-920X	Hot/Cold Dry Bath	Heating & cooling	Heating: room temp. ~110°C Cooling: room temp. ~ below room temp. 25°C	± 0.5	5.5

# Dry Bath Incubators



## Shaker Incubator

### Features

- Excellent temperature control system
- Can maintain hot or cold temperatures
- Orbital shaking movement function
- Supports creating and saving custom programs
- Various interchangeable heating blocks are available (24 x 0.5ml, 24 x 1.5ml, 24 x 2ml, 8 x 5ml, 8 x 15ml, 4 x 50ml, well plate, 0.2 x 96 PCR plate)

Cat #	Type	Functions	Temperature range	Max heating rate [°C/min]	Max cooling rate [°C/min]	Shaking speed range [rpm]
01-930X	Shaker Incubator	Heating, cooling, & mixing	Heating: room temp. ~ 100°C Cooling: room temp. ~ below room temp. 25°C	5.5	5 (110°C - room temp.) 0.5 (below room temp.)	300–1500



One Block Unit



Dual Block Unit

## Elite Series Dry Bath Incubators

### Features

- PID temperature control maintains temperature accuracy
- Leak-proof molded aluminum alloy chamber with PTFE coating
- Multi-functional: can also be used as a water bath or bead bath
- Various interchangeable heating blocks are available (0.2ml tubes x 64 or PCR 8-strip tubes x 8, 0.5ml tubes x 20, 1.5ml or 2.0ml tubes x 20, 15ml x centrifuge tubes x12, 50ml x centrifuge tubes x4)

\* Blocks are not included, need to buy separately.

Cat #	Type	Display	Temperature Control Range [°C]	Temperature Increment [°C]	Temperature Accuracy at 37 [°C]	Operation Modes
03-4221	Elite Series One-Block Dry Bath Incubator	LCD Display	5 above ambient to 150	0.10	±20	Continuous or timed up to 99 hr:59 min
03-4222	Elite Series Dual Block Dry Bath Incubator					

## Dry bath

### Features

- A wide range of temperature control up to 105°C /150°C .
- Overheating protection.
- USB interface can be used to trace historical data.
- Sound reminder function.
- External temperature sensor.
- Block equipped with a lid for heat preservation and prevent pollution.
- Knob adjustment is easy to operate.



Cat #	Type	Temperature setting range[°C]	Output Current / Inc [mA]	Power [w]	Operating temperature[°C]
01-900X	Dry bath	25~105	25-90:±0.3 90-105:±0.6	100	+10~40
01-9A0X	Dry bath	25~105	25-90:±0.3 90-105:±0.6	200	+10~40
01-950X	Dry bath	25~150	25-90:±0.3 90-105:±0.6	100	+10~40
01-960X	Dry bath	25~150	25-90:±0.3 90-105:±0.6	200	+10~40



## Mini Dry bath

### Features

- Light in weight
- LCD display of both temperature and time.
- Rapid calibration support
- Overheating protection
- Optional blocks with different capacities are available
- Safe and stable
- USB interface to save the data
- Mini 01-970x with hot lid provided to preserve the generated heat

Cat #	Type	Temperature setting range[°C]	Temperature control accuracy[°C]	Power [w]	Operating temperature[°C]
01-970X	Mini Dry bath	0~100	±0.5	60	+10~40
01-980X	Mini Dry bath	0~100	±0.5	60	+10~40
01-990X	Mini Dry bath	25~150	±0.5	60	+10~40



# Electrophoresis



Mini 300V Power Supply



300V Power Supply

## Power Supplies

### Features

- Stackable and programmable
- Multiple safety features: no-load detection, shrouded plugs and sockets, leakage detection, over-temperature protection, crossover protection, full floating, over-current/over-voltage detection

Cat #	Type	Output Voltage / Inc [V]	Output Current / Inc [mA]	Max Power [W]
03-1300	Mini 300V Power Supply	10-300/1	10-400/1	60
03-2310	300V Power Supply	5-300/1	1-700/1	150

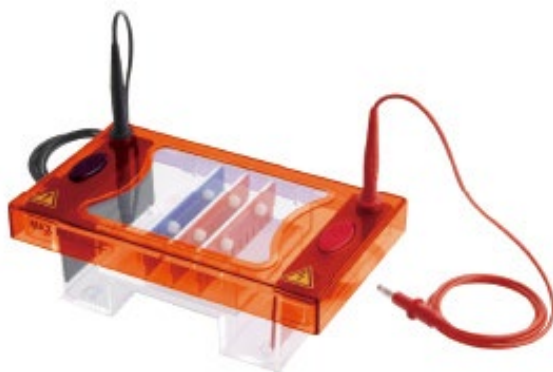

03-3100

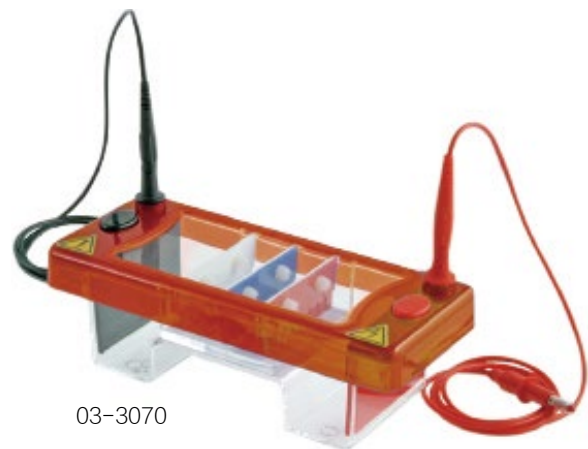

03-3070

## Electrophoresis Tanks

### Features

- Injection molded, leak-proof tank
- No tapes, clamps, or springs required
- Low buffer consumption
- Multiple tray sizes and combs available

Cat #	Tank Dimensions [W x L x H]	Gel Dimensions [mm]	Max. Sample Capacity [mm]	Rapid Casting Gel
03-3070	210 x 90 x 90mm	70 x 70, 70 x 100	32 for 70 x 70    64 for 70 x 100	Offer gel maker
03-3100	220 x 125 x 90mm	100 x 70, 100 x 100	50 for 100 x 70    100 for 100 x 100	Offer gel maker

# BluView Transilluminator

Super bright blue LED lights can be used with a variety of safe dyes, and the lights are harmless and safe to view the experiment result. You can cut the gel with accuracy. With its compact size and light weight, the transilluminator occupies little of your lab bench and is easy to move from lab to lab.



## BluView Transilluminator

### Features

- Compact, and easy to carry
- Aluminum alloy casing design
- Low heat dispersion
- Energy saving product
- 470nm harmless blue light for direct human contact
- Thinner and more lightweight body
- Use accessories to document experiment results by a smart phone

Cat #	Blue Light Wavelength [nm]	Base Design	Construction Material	Power Adaptor	Filter Viewing Surface Dimensions [mm]
03-6210	470	Flat bed	Aluminum alloy	12VDC/5A, 60W Max.	153×153

# BluView Transilluminator

## The GelSMART gel imaging system

### Features

- Compact foot print with a field of 10x10cm
- Simple operation of experiments and quick acquisition of results
- Epi-blue light diminishes UV exposure to lab personnel and DNA damage in the sample.
- Adjustable epi-blue light source emits light with high intensity and minimum heat for better light control.
- Filter holders can accommodate most popular smartphones/tablets smartphones/tablets.
- Optional light-weight app



### Applications



Cat #	Type	Light Source	White Light Plate	Filter Protective Shield	Power Supply
01-420X	The GelSMART gel imaging system	470nm epi blue light	10-400/1	Amber, using when observing or cutting gels	12V / 1.5A AC power adapter

# Application Guidelines

## Maximum centrifugal acceleration force can be influenced by following criteria:

- Use of organic solutions, temperature below 0°C, centrifuging without centrifuge adapter, etc. Conduct a trial run to determine proper conditions before any critical use begins.
- The RCF (relative centrifugal force) or G ratings for our disposable centrifuge tubes have been established at room temperature using tubes filled to nominal capacity with water and centrifuging for 30 minutes. recommended carriers, adapters, and cushions that fully support the tubes. If an angle head rotor is used or proper support is not provided, G values will be lower.
- Do not confuse speed or revolutions per minute (RPM) with relative centrifugal force (RCF). Instructions for centrifuging a sample at a given RPM and time are incomplete unless the rotor or radius is specified. Protocols should always state the time and RCF value for centrifuging a sample.

## Autoclaving guideline for Plastics

To ensure successful steam sterilization of your plastic labware please adhere to the following guidelines:

PLEASE NOTE THAT NOT ALL PRODUCTS ARE AUTOCLAVABLE. Autoclave plastic consumables at 121°C and 15psi/1 atm for 15 minutes. Do not use a dry cycle, as this may cause deformation or weakening of the plastic. Allow temperature within the autoclave to return to 80°C or below before removing products.

## Our Commitment to Quality

At Biologix, we look at quality from every angle in terms of functionality, safety, purity, formulation, consistency, manufacturing, customer service, technical support, and much more, all in order to consistently ensure customer satisfaction.

According to the detailed QA/QC procedures for our manufacturing facility, each and every product is traceable by lot, regardless of packaging format. Products must go through a five-step human inspection before being released for packaging.

Our facility is equipped with the latest instruments and technology from the most trusted manufacturers, ensuring that Biologix applies the most stringent standards to certify that products are free from RNase, DNase, endotoxin (pyrogens), etc.

In addition to being ISO 9001:2015, CE, and FDA compliant, we also make available to our customers lot-specific certificates such as Sterilization Certificates, Nuclease Free Certificates, Certificates of Origin, etc. Please contact Biologix for Certificates of Compliance.

Note: Product parameters within this catalogue are for reference only.

# Chemical Resistance Form

## For Biologix Plastic Laboratory Supplies

	PS	PP	HDPE	LDPE	PVC	CA	PC	CN	NY	MCE	PTFE	PET
<b>Acids</b>												
Hydrochloric acid (25%)	G	G	G	G	G	N	R	R	N	O	R	R
Hydrochloric acid (concentrated)	F	G	G	G	F	N	R	N	N	N	R	O
Nitric acid (concentrated)	P	P	N	N	P	N	R	N	N	N	O	N
Nitric acid (25%)	P	G	F	F	F	N	R	L	N	O	R	R
<b>Alcohols</b>												
Butanol	G	G	G	G	G	R	R	R	R	R	R	R
Ethanol	G	G	G	G	G	R	R	N	R	O	R	R
Methanol	G	G	G	G	G	R	R	N	R	O	R	R
<b>Amines</b>												
Aniline	G	G	G	G	P	N	N	R	R	N	R	O
Dimethylformamide	P	G	G	G	F	N	N	N	R	N	R	N
<b>Bases</b>												
Ammonium hydroxide (25%)	F	G	G	G	G	R	N	R	R	O	N	O
Ammonium hydroxide (1N)	F	G	G	G	G	N	N	R	R	O	N	N
Sodium hydroxide	G	G	G	G	G	N	N	N	R	N	R	N
<b>Hydrocarbons</b>												
Hexane	P	G	G	G	F	R	R	R	R	R	R	R
Toluene	P	G	N	N	P	R	O	R	R	R	R	N
Xylene	P	F	P	N	P	R	R	R	R	R	R	N
Dioxane	P	G	G	F	P	N	N	N	R	N	R	R
Dimethylsulfoxide (DMSO)	P	G	G	G	P	N	N	N	R	N	R	O*
<b>Halogenated Hydrocarbons</b>												
Chloroform	P	G	P	N	P	N	N	R	R	N	R	R
Methylene chloride	P	F	P	N	P	N	N	R	R	N	R	N
<b>Ketones</b>												
Acetone	P	G	G	G	P	N	O	N	R	N	R	R
Methyl ethyl diketone	P	G	G	G	P	N	O	N	R	O	R	R

\* Can be used with aqueous solutions containing up to 20% DMSO.

The above chemical resistance chart is meant to be used as a guide only.

### LEGEND

R = Recommended

L = Limited Resistance

N = Not Recommended

O = Testing Advised

F = Fair

G = Good

P = Poor

PS = Polystyrene

PP = Polypropylene

PVC = Polyvinyl Chloride

CA = Cellulose Acetate

PC = Polycarbonate

PTFE = Polytetrafluorethylene (Teflon)

CN = Cellulose Nitrate

NY = Nylon

MCE = Mixed Cellulose Esters

PET = Polyethylene Terephthalate





115230, Москва, Россия,  
Каширское шоссе 3, корп. 2, стр. 4/9  
Тел.: +7 (499) 682 6555, (495) 640 4192,  
[biomol@chimmed.ru](mailto:biomol@chimmed.ru)  
[www.chimmed.ru](http://www.chimmed.ru)